



Z.S. 72





# BRITISH BIRDS

AN ILLUSTRATED MONTHLY MAGAZINE

Edited by

E. M. NICHOLSON

W. B. ALEXANDER

A. W. BOYD

I. J. FERGUSON-LEES

P. A. D. HOLLOM

N. F. TICEHURST

*Photographic Editor: G. K. YEATES*

Volume LI

1958



H. F. & G. WITHERBY LTD  
5 Warwick Court · London · W.C.1

# LIST OF ILLUSTRATIONS

## PHOTOGRAPHIC PLATES IN BLACK AND WHITE

	PAGE	
<i>Plates 1-12</i>	Habitats and birds in the Coto Doñana, Spain, including Black-winged Stilt ( <i>Himantopus himantopus</i> ), Fantailed Warbler ( <i>Cisticola juncidis</i> ), Short-toed Eagle ( <i>Circuëtus gallicus</i> ), White Storks ( <i>Ciconia ciconia</i> ), Little Egrets ( <i>Egretta garzetta</i> ), Night Herons ( <i>Nycticorax nycticorax</i> ), Imperial Eagle ( <i>Aquila heliaca</i> ), Black Kite ( <i>Milvus migrans</i> ), Egyptian Vulture ( <i>Neophron percnopterus</i> ), Griffon Vulture ( <i>Gyps fulvus</i> ), Great Grey Shrike ( <i>Lanius excubitor</i> ), Azure-winged Magpie ( <i>Cyanopica cyanus</i> ) and Short-toed Lark ( <i>Calandrella cinerea</i> ), as well as nesting areas of other species (Eric Hosking, E. M. Nicholson and B. W. Tucker) ... .. facing	20
<i>Plates 13-16</i>	Pygmy Owls ( <i>Glaucidium passerinum</i> ), adults with prey and at nest, and juveniles, Sweden (Kurt Ellström, Sigvar Rosén and Enar Sjöberg) ... .. facing	62
<i>Plate 17</i>	Black-headed Gulls ( <i>Larus ridibundus</i> ) and Black-necked Grebe ( <i>Podiceps nigricollis</i> ), nesting association, Germany (Ilse Makatsch) ... ..	
<i>Plates 18-20</i>	Aerial views of Coll and Tiree, Inner Hebrides, to show habitats of birds (R.A.F. Official) ... .. facing	63
<i>Plates 21-24</i>	Choughs ( <i>Pyrhcorax pyrrhcorax</i> ) and Alpine Choughs ( <i>P. graculus</i> ), adults at nest, and habitats, Wales and Italy (Harold Platt and Richard Vaughan) facing	108
<i>Plates 25-28</i>	Scops Owls ( <i>Otus scops</i> ), adults and young at nest, adult in the hand, Hungary (K. Koffán) ... .. facing	148
<i>Plates 29-32</i>	Capercaillie ( <i>Tetrao urogallus</i> ), male displaying, and habitat, Sweden (Kurt Ellström, Enar Sjöberg and Jonas Svensk) ... .. facing	186
<i>Plate 33</i>	Black-throated Thrush ( <i>Turdus ruficollis atrogularis</i> ), male in the hand, Fair Isle (Angela Davis) ... ..	
<i>Plates 34-35</i>	Cormorants ( <i>Phalacrocorax carbo</i> ), to illustrate development of white head plumage, Kirkcudbright, Northumberland and Cheshire (Austin Barton and J. Edelsten) ... ..	
<i>Plate 36</i>	Pallas's Warbler ( <i>Phylloscopus proregulus</i> ), bird in the hand, Norfolk (J. L. Cutbill) ... .. facing	187
<i>Plates 37-40</i>	Goshawks ( <i>Accipiter gentilis</i> ) adults and young with prey and at nest, Sweden (Kurt Ellström and Jonas Svensk) ... .. facing	230
<i>Plates 41-44</i>	Frigate Petrels ( <i>Pelagodroma marina</i> ), adults at burrow and in flight at night, W. Australia (John Warham) facing	268
<i>Plates 45-48</i>	Bridled Terns ( <i>Sterna anaethetus</i> ), adults at nest, displaying and fishing, W. Australia (John Warham) facing	302

# LIST OF ILLUSTRATIONS

		PAGE
<i>Plates 49-60</i>	Habitats and birds in the Camargue, France, including Gull-billed Tern ( <i>Gelochelidon nilotica</i> ), Avocets ( <i>Recurvirostra avosetta</i> ), Flamingos ( <i>Phoenicopterus ruber</i> ), Little Egret ( <i>Egretta garzetta</i> ), Penduline Tit ( <i>Remiz pendulinus</i> ), Spectacled Warbler ( <i>Sylvia conspicillata</i> ), Great Reed Warbler ( <i>Acrocephalus arundinaceus</i> ), Pratincole ( <i>Glareola pratincola</i> ), Black-winged Stilts ( <i>Himantopus himantopus</i> ), Whiskered Tern ( <i>Chlidonias hybrida</i> ), Purple Heron ( <i>Ardea purpurea</i> ) and Black-eared Wheatear ( <i>Oenanthe hispanica</i> ), as well as nesting areas of other species (L. Hoffmann and G. K. Yeates) ... .. facing	344
<i>Plates 61-63</i>	Views of Hirta, St. Kilda, to show habitats of St. Kilda Wrens ( <i>Troglodytes troglodytes hirtensis</i> ) (J. Morton Boyd and R.A.F. Official) ... .. facing	388
<i>Plates 64-67</i>	Little Shearwaters ( <i>Procellaria baroli</i> ), adults and young in burrow, and adult flying at night, W. Australia (John Warham) ... ..	
<i>Plate 68</i>	Factory roof at Mertyr Tydfil, Glamorgan, to show nesting site of Lesser Black-backed and Herring Gulls ( <i>Larus fuscus</i> and <i>argentatus</i> ) (H. Morrey Salmon) facing	389
<i>Plates 69-74</i>	Sound spectographs of song or sub-song of Blackbird ( <i>Turdus merula</i> ), Song Thrush ( <i>T. philomelos</i> ), Mistle Thrush ( <i>T. viscivorus</i> ), Redwing ( <i>T. musicus</i> ), Canary ( <i>Serinus c. canarius</i> ), American Goldfinch ( <i>Spinus tristis</i> ), Corn Bunting ( <i>Emberiza calandra</i> ), Crossbill ( <i>Loxia c. curvirostra</i> ), Scottish Crossbill ( <i>L. pytyopsittacus scotica</i> ) and Dunnock ( <i>Prunella modularis</i> ) facing	514
<i>Plates 75-76</i>	Blue and Coal Tits ( <i>Parus caeruleus</i> and <i>ater</i> ) at "perspex" apparatus used in intelligence tests (Peter Blomfield and Brian Pratt) ... .. facing	515





# BRITISH BIRDS



JANUARY 1958

THREE SHILLINGS

# BRITISH BIRDS

AN ILLUSTRATED MONTHLY MAGAZINE

Edited by

E. M. NICHOLSON

W. B. ALEXANDER                      A. W. BOYD

I. J. FERGUSON-LEES

P. A. D. HOLLON                      N. F. TICEHURST

*Editorial Address* : 30, St. Leonard's Avenue, Bedford.

*Photographic Editor*: G. K. YEATES

Annual Subscription £2 (including postage and despatch)

---

---

## CONTENTS OF VOLUME LI, NUMBER 1, JANUARY 1958

---

	PAGE
An ecological sketch of the Coto Doñana. By J. A. Valverde. Photographs by Eric Hosking, E. M. Nicholson and the late B. W. Tucker (plates 1-12) ... ..	1
Broken eggs in Peregrine eyries. By D. A. Ratcliffe ... ..	23
Uncommon migrants at Portland Bill during the autumn of 1956. By K. D. Smith and Dr. J. S. Ash ... ..	27
Notes on the Wren in the Aran Islands, Ireland. By Rev. Edward A. Armstrong ... ..	29
Notes:—	
American Snipe in Lancashire (Alfred Hazelwood) ... ..	35
Collared Flycatcher on Bardsey (Reginald W. Arthur) ... ..	36
Alpine Swift in Norfolk (R. A. F. Cox) ... ..	36
Red-flanked Bluetail in Kent (Dennis F. Harle) ... ..	37
Reviews:—	
<i>Tales of a Wildfowler</i> . By Arthur Cadman. Illustrated by Peter Scott	37
<i>Birds on the Wing</i> and <i>Birds and Nests</i> (sets of colour slides). From photographs by Eric Hosking ... ..	38
Requests for Information:—	
Field investigations of the B.T.O. ... ..	39
Recent reports and news. By I. J. Ferguson-Lees ... ..	39

---

Cover photograph by Harold R. Lowes: Short eared Owl (*Isio flammeus*)



PURCHASED  
31-1-1958

VOL. LI  
No. 1

JANUARY  
1958



## BRITISH BIRDS

---

### AN ECOLOGICAL SKETCH OF THE COTO DONANA

By J. A. VALVERDE

(*Instituto de Aclimatacion Almeria, Spain*)

(Plates 1-12)

THE RIVER GUADALQUIVIR flows a distance of some 360 miles in Andalusia in southern Spain, before entering the Atlantic Ocean below Sanlucar, about 70 miles north-west of Tarifa and the narrowest part of the Straits of Gibraltar. For the last 50 miles of its course, from below Coria (near Seville), it traverses the *marismas* or marshes of its delta—the greatest area of swamp in the Iberian Peninsula, covering some 620 square miles. Except where the actual river itself, by then half-a-mile broad, flows out into the sea near Sanlucar, the *marismas* have become cut off from the Atlantic by a remarkable sand-bar that extends the 40-odd miles from the mouth of the Guadalquivir west to the Rio Tinto—a tongue of land which incorporates some of the highest sand-dunes in Europe (see Nicholson, Ferguson-Lees and Hollom, 1957). This tongue of land varies in width from about  $2\frac{1}{2}$  miles to  $7\frac{1}{2}$  miles (approximately 4-12 kilometres), and it runs more or less from south-east to north-west. The south-eastern half of this strip forms the Coto Doñana proper (though part of it is now under separate ownership and is known as Las Marismillas) and this paper is concerned solely with that area—i.e. the land and neighbouring *marismas* between the Guadalquivir mouth and the north-western boundaries of the Coto Doñana; these boundaries run from near the Torre de la Higuera to the vicinity of El Rocio (see *op. cit.*, map on pages 508-509).

The soil on the Coto Doñana proper is sandy on the dry land, and muddy over the whole extent of the *marismas*. If one takes a section across this tongue of land, from the sea to the *marismas*, running more or less north-eastwards from near Matalascañas and passing close to the Palacio de Doñana (thus cutting Latitude  $37^\circ$ ),

one has the following main habitats (see Fig. 1):

(1) Beach.

(2) Zone of dunes and coastal slacks, with a poor vegetation of marram grass (*Ammophila arenaria*) on the seaward side and of rough growth in the hollows (see plates 4 centre and bottom, and 10 upper; also *antea* plate 69 upper\*).

(3) Woods of pine (*Pinus pinea*) and juniper (*Juniperus oxycedrus* and *phoenicea*) occupying parts of the dunes and the intervening hollows, and the fringes of these hollows, with isolated fragments on the *Halimium* plain (plates 4 top, 5 centre and bottom, 6 upper; also *antea* 69 lower and 72 right; *Halimium* is illustrated on 10 upper).

(4) *Halimium* thicket, covering the flat ground between the pines and the *marismas*; cork oaks (*Quercus suber*) are scattered over this zone (plate 5 top; also *antea* 76 lower).

(5) Fresh-water lagoons scattered between the pinewoods and the *Halimium/Quercus* plain (plate 9 centre and bottom; also *antea* 77 lower).

(6) Grasslands along the fringe of the *marismas*, with a belt of *Juncus* (rushes) forming a *juncigraminetum* (plate 1 right; also *antea* 77 upper and 78 bottom).

(7) Zone of *Carex-Scirpus* (sedges and bulrushes), flushed most of the year by fresh water from the Madre de las Marismas, a channel running parallel to the Coto Doñana sand-bar and bearing fresh water to the *marismas* (*antea* plates 70 lower and 78 top).

(8) Zone of cracked clay covered with *Salicornia* (glasswort) shrubs, dry most of the year and covering the greater part of the *marismas* (plates 8 and 12 left; also *antea* 70 upper and 72 left).

The irregular distribution of the woods in the tongue of land, where the pines are massed towards the south-east and the *Halimium/Quercus* thicket towards the north-west, results in transects from the sea to the *marismas* at either end of the *marisma* showing only one of these main vegetation types. The dunes themselves reach the edge of the *marisma* along a good part of the Coto, leaving behind them an area occupied by pines.

The moist hollows in the extreme south-east and a patch adjoining the *marisma* in the centre of the Coto, near the little lake Sopeton, are occupied by bushes of pistachio (*Pistacea lentiscus*), which deserve separate mention as a habitat. Buildings are dotted here and there in the region and will also be considered separately, as well as cultivated gardens.

\*In view of the number of relevant photographs that appeared in our last issue (December 1957) as illustrations to the introductory paper referred to in the first paragraph, it has been decided to include references to them in the present text.—Eds.

*The beach.*

The whole coast between Huelva and the mouth of the Guadalquivir is formed by a long and almost straight beach, relieved only by stone towers built in the Middle Ages to guard the shore against Barbary pirates. The beach is of bare sand, with some stony tracts of foreshore, passing imperceptibly into foredunes and coastal slacks. Shore vegetation is sparse.

Only one bird, the Kentish Plover (*Charadrius alexandrinus*), is known certainly to nest on the beach, and that rather thinly, but it is more than possible that one or two single pairs of Caspian Terns (*Hydroprogne caspia*) also breed there. A pair of Peregrines (*Falco peregrinus*) breeds on at least one of the towers.

*The dunes and coastal slacks.*

Parallel lines of dunes between the coast and the interior are separated by little valleys and more or less flat hollows. A very far advanced line of dunes meets the *marismas* between Betalengua and Sopeton, sloping steeply down to the water.

The dunes nearest the sea are partly covered with thin marram grass (*Ammophila arenaria*), which soon disappears as one goes inland. The mobile dunes advance naked right across to the *marisma*. The stabilized dunes are covered with scattered rough growth, predominantly *Corema album* (a heather-like shrub), which blends imperceptibly into the *Halimium* thicket as the soil grows firmer, but this is already far from the sea.

The hollows between the dunes, and the coastal slacks, carry a low and tussocky vegetation, mingled occasionally with stunted pines (plate 4 bottom). It is here that many migratory birds just arrived from Africa over the sea make a halt.

The fauna of the *Ammophila* and *Corema* dunes is poor. Only two species of birds breed there, neither of them commonly:

- Stone Curlew (*Burhinus oedichenus*)
- Thekla Lark (*Galerida theklae*)

In addition the following reptiles are found in these areas:

- Spine-foot Lizard (*Acanthodactylus erythrurus*)—common
- Algerian Sand Lizard (*Psammodromus algirus*)—less common
- Lataste's Viper (*Vipera latastei*)—common in *Ammophila* and *Corema*
- Montpellier Snake (*Malpolon monspessulana*)—fairly common
- Greek Tortoise (*Testudo graeca*)

This population is thus predominantly composed of insectivorous animals and their predators (*Vipera*, *Malpolon*).

In comparison with the rest of the Coto the most important characteristic of this zone is the poverty and thinness of the vegetation. The wide open spaces where snakes or hares can easily be surprised make this habitat the favourite hunting ground

\*See plate 10 upper for illustration of some of the dune flora. The biotope descriptions in this paper mention only the most significant plants—those which give each area its characteristic appearance—and the animal lists are confined to the birds, mammals, reptiles, batrachians and fish which breed regularly in any biotope (though some with very small numbers are included).

Fig 2

Fig 3

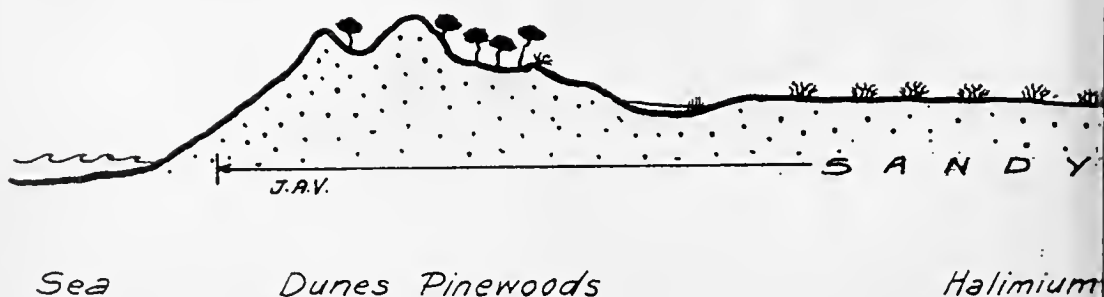

FIG. 1—KEY SECTION OF COTO DOÑANA FROM ATLANTIC THROUGH :  
 This shows the relative positions of the more detailed sketches of each main zone that  
 (Reproduced from *Portrait of a Wilderness* (to be published in March), b

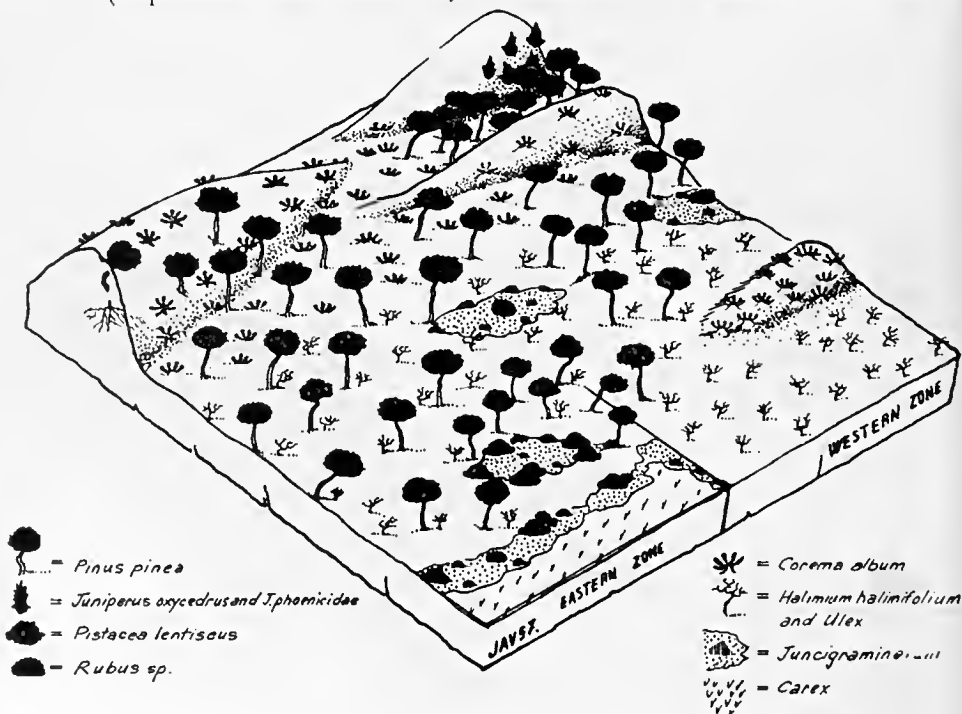

FIG. 2—SKETCH OF SAND-DUNES AND WOODS OF STONE PINES

This shows how in the eastern section of the area the pinewoods reach to the *marismas* and are separated from the water only by a narrow belt of *juncigraminetum*, while in the western part juniper woods occur near the coast and the pines are divorced from the *marismas* by the open *Halimium* plain (see pages 6-8 and plates 4 and 10; also *antea* plates 69, 72 right and 77 upper). The moist hollows in the eastern zone hold clumps of pistachio (*Pistacea*), while bramble (*Rubus*) is dominant in the west. The burial of the pines by the mobile dunes is illustrated on the left of the sketch.

of the Short-toed Eagle (*Circaëtus gallicus*) (plate 3), which is attached to this sandy zone, and one of the places preferred by the Imperial Eagle (*Aquila heliaca*) (plate 7 upper) for hunting hares.

Fig 4

Fig 5



thicket (jaguarzal) cork oak savannah *Juncigraminetum* muddy soil marismas

PINEWOODS AND OTHER SANDY SOIL ZONES TO MUDDY MARISMAS

in Figs. 2, 3, 4 and 5 (see also pages 1-2). The vertical scale is somewhat exaggerated. of Guy Mountfort and Messrs. Hutchinson & Co. (Publishers) Ltd.)

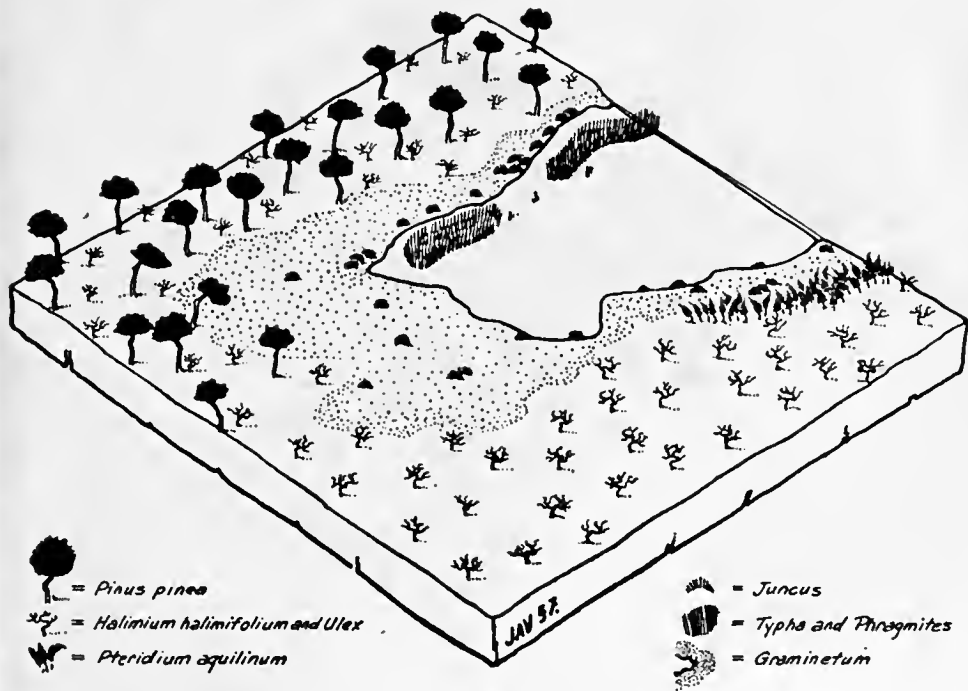

FIG. 3—SKETCH OF SURROUNDINGS OF A FRESH-WATER LAGOON

The lagoons are considered to be vestiges of an old arm of the Guadalquivir and they lie in a series along the line separating the pinewoods from the *Halimium* plain, so that each lagoon has pines on one side, thicket on the other. Note the *juncigraminetum* which is often extensive by the lakes, and the stands of reed-mace (*Typha*) and water-reed (*Phragmites*) which are found in three of the lagoons and provide nesting-places for Coot and Crested Coot, White-headed Duck and Purple Heron (see pages 19-21 and plates 9 centre and bottom; also *antea* plate 77 lower).

*The pinewoods.*

Pines—stone pines (*Pinus pinea*)—were probably introduced to the Coto during the 18th or the 19th century. They form,

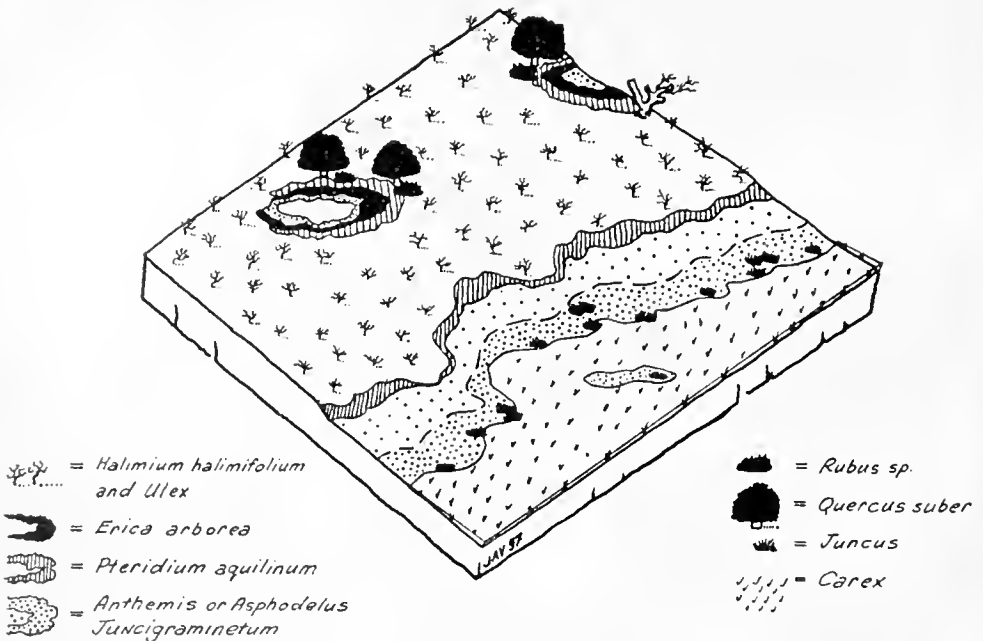

FIG. 4—SKETCH OF "PARK-LAND" AND MARISMA EDGE

The "park-land" effect (see page 9 and plate 5 top; also *antea* plate 76 lower) is formed by the greater abundance of the cork oaks (*Quercus*) in that part of the *Halimium* plain that borders the *marismas*—the result of the more humid soil there. This sketch illustrates the way in which moist depressions encourage bramble (*Rubus*), bracken (*Pteridium*) and tree-heath (*Erica arborea*) (plate 12 right). This zone is divided from the sedge (*Carex*) of the *marismas* by a strip of bracken and a *juncigraminetum* (see page 11 and plate 1 right).

accordingly, a relatively new habitat, which has doubtless partially replaced the *Halimium* thicket and the park-like sprinkling of cork oaks. The present avifauna probably colonized this habitat from the pinewoods to the north of the *marismas*.

The pine-woods (*pinares* in Spanish) in the extreme south-east begin at the edge of the *marisma* and extend north-westwards strung out between the dunes and the plains of *Halimium*, narrowing gradually until they fade out not far from Torre de la Higuera. Among the dunes such woods are clustered in series of hollows, often entirely ringed around by ridges of bare sand, and are called *corrales* (see plate 4 bottom). At the front of the mobile dunes the advancing sands overwhelm many trees whose crowns remain visible on the slopes or above the ridges (*antea* plate 72 right). In the direction of the *Halimium* plains, sandy zones with little vegetation, or lagoons, separate the main pine-woods from the *jaguarzal* or thicket, but there are also some scattered stands of stunted pines here and there on the plain (Pinar de San Agustín, del Martínazo, de la Algaidilla, de la Pez, etc.) (plates 5 centre and 6 upper).

Junipers (*Juniperus oxycedrus* and *J. phoenicea*) are dispersed among the pinewoods near the sea and sometimes cover the fixed



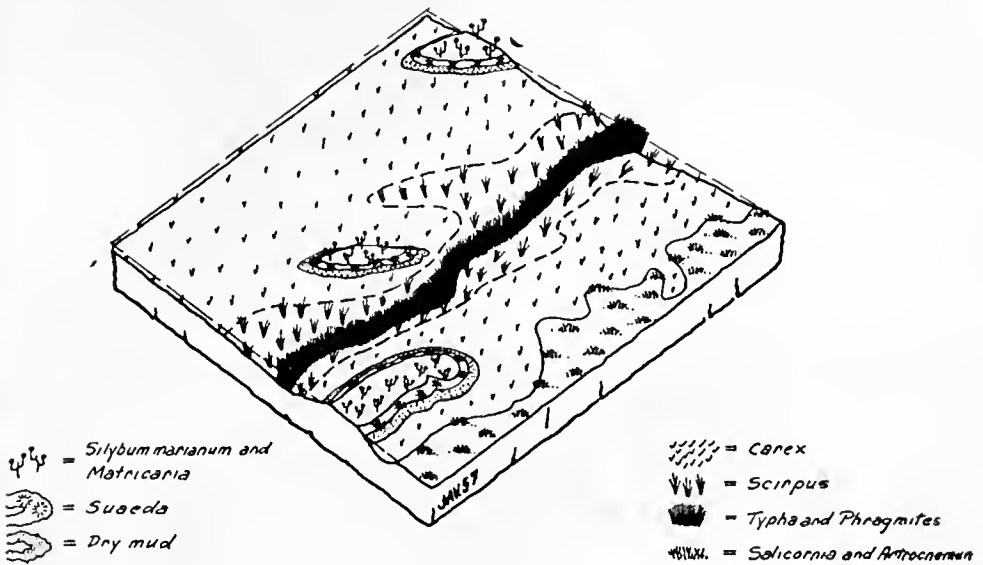

FIG. 5—SKETCH OF INNER ZONES OF THE MARISMAS

Down the centre the course of the fresh-water stream called La Madre de las Marismas (see page 15) is marked by a stand of reed-mace (*Typha*) and water-reed (*Phragmites*). This is flanked by zones of bulrush (*Scirpus*), and then by sedge (*Carex*) (antea plate 70 lower) dotted with islands (*vetas*) of mud, *Suaeda* and thistles (*Silybum*). The greater part of the *marismas* is a zone of cracked clay covered with *Salicornia* to varying extents; the *Salicornia* parts are much drier than the other *marisma* zones (see pages 15-16 and plates 8 and 12 left; also antea plates 70 upper and 72 left).

dunes. Towards the north-west the line of the pinewoods is continued by little juniper woods, parallel with the coast.

The shrub layer of the pinewood on the seaward side is formed by *Corema*, broom (*Genista*), rosemary (*Rosmarinus*), lavender (*Lavandula*), etc., which are soon replaced by *Halimium* thicket throughout the middle zone and the areas fringing the *marismas*. This *Halimium*, thin and stunted compared with that of the deforested plains, also maintains many lizards (*Acanthodactylus*, *Psammmodromus*). Charcoal-burners have an effect on the shrub layer and on the pines themselves (plate 5 bottom).

In the *Marismillas*, in the southern part of the tongue of land forming the Coto, the better soil carries a denser pinewood with larger trees. The *Halimium* zone is almost absent there and the pinewood reaches to the *marismas* leaving room between it and the water only for a narrow belt of *juucigraminetum* with some pistachio (eastern section of Fig. 2; also plates 10 lower and antea 77 upper). In the moist hollows, occupied by meadows of grass and *Juucus*, thickets of pistachio also grow in the middle of the *pinar*.

In the western part (western section of Fig. 2) the pinewoods are always separated from the *marismas* by the *Halimium* plain or by dunes. In the hollows of the *pinar* in this zone grasses predominate with a few bushes of bramble (*Rubus*).

The breeding avifauna of the pinewoods consists of the following species:

## (1) Breeding in the pines

## A—On the branches

Imperial Eagle (*Aquila heliaca*) (plate 7 upper)  
 Booted Eagle (*Hieraëtus pennatus*)  
 Buzzard (*Buteo buteo*)  
 Kite (*Milvus milvus*)  
 Black Kite (*Milvus migrans*)  
 Short-toed Eagle (*Circaëtus gallicus*) (plate 3)  
 Hobby (*Falco subbuteo*)  
 Kestrel (*Falco tinnunculus*)  
 Woodpigeon (*Columba palumbus*)  
 Raven (*Corvus corax*)  
 Magpie (*Pica pica*)—at the edges  
 Azure-winged Magpie (*Cyanopica cyanus*) (plate 11 upper)  
 Great Grey Shrike (*Lanius excubitor*)  
 Woodchat Shrike (*Lanius senator*)  
 Goldfinch (*Carduelis carduelis*)—near houses  
 Serin (*Serinus canarius*)—rare  
 B—In holes  
 Green Woodpecker (*Picus viridis*)

## (2) Breeding under the pines

C—In bushes of *Rubus*, *Pistacea*, etc.

Woodpigeon (*Columba palumbus*)  
 Turtle Dove (*Streptopelia turtur*)  
 Great Spotted Cuckoo (*Clamator glandarius*)  
 Magpie (*Pica pica*)  
 Blackbird (*Turdus merula*)  
 Nightingale (*Luscinia megarhynchos*)  
 Orphean Warbler (*Sylvia hortensis*)  
 Sardinian Warbler (*Sylvia melanocephala*)  
 Dartford Warbler (*Sylvia undata*)  
 Great Grey Shrike (*Lanius excubitor*) (plate 9 top)

## D—On the ground

Red-legged Partridge (*Alectoris rufa*)  
 Stone Curlew (*Burhinus oedicephalus*)  
 Red-necked Nightjar (*Caprimulgus ruficollis*)  
 Woodlark (*Lullula arborea*)

Lizards and snakes (especially *Malpolon*, the Montpellier Snake) are very common (the list is exactly the same as that given for the *Halimium* thicket on page 9). Among mammals, the Garden Dormouse (*Eliomys quercinus*) is abundant and the Mediterranean Black Rat (*Rattus rattus frugivorus*) is also found. Both profit by the heavy seed crops of the pine. The Wild Boar (*Sus scrofa*) here attains a density much higher than in the cork oaks and *Halimium*: this is above all due to the abundance of food provided for it by the pine cones.

The areas of pistachio bushes are favourite habitats of the Mongoose (*Herpestes ichneumon*) which finds in the moist patches an abundance of its preferred prey, the Rabbit (*Oryctolagus cuniculus*). The Mongoose, Wild Boar and Fallow Deer (*Dama dama*) are the three species of mammals which are more abundant in the eastern than in the western section, but in the case of the last-named that is not due to the pinewoods but to the greater importance of the meadows and moist patches as a habitat for it.

*The Halimium thicket and the cork oak savannah.*

The *Halimium* thicket (*jaguarzal* or *monte blanco* in Spanish) occupies the plains of the interior of the Coto, notably in the extreme north-west. In area it forms the most extensive of the Coto habitats.

The cork oaks, scattered over the plain, isolated or in little groups, give it a park-like appearance. This is especially conspicuous in the zone fringing the *marismas* where the trees are much more abundant on account of the greater humidity of the

soil (see plate 5 top; also *antea* 76 lower).

This zone is depicted in Fig. 4, which shows the *Halimium* thicket or heath and the moist depressions favoured by the cork oaks and brambles (*Rubus*).

The *Halimium* or *jaguarzo* is a very pale-coloured shrub of about 1 to 1.5 metres (40-60 inches) in height (see plate 10 upper; *cf.* height of horses in plate 5 centre). It spreads over the ground more or less densely and with a uniform canopy, forming a thick cover which, however, allows easy passage through it. Some other thorny shrubs mingle among the *Halimium*, notably various species of broom (*Genista*) and gorse (*Ulex*) which form dense and impenetrable thickets in the hollows of the ground, where the fauna can find quiet refuges. Passage through these thorn thickets is impossible and they are the favourite haunt of Lynxes (*Lynx pardina*), small warblers (*Sylvia*), etc.

Deeper depressions carry a belt of bracken (*Pteridium aquilinum*), mingled with brambles (*Rubus*). It is there that the cork oaks grow best. Lower still grow dense stands of tree-heath (*Erica arborea*), perhaps 3 metres (10 feet) high and mixed with brambles (plate 12 right), which form the preferred nesting site for herons in the colony at Algaida (*antea* plate 73).

In the flat bottoms of such depressions occur little patches of grassland that have been rooted up by Wild Boars searching for the palatable young shoots of herbs. Sometimes there is a little pool also.

The cork oaks are imposing trees, old and gnarled, thrusting their lightly leaved crowns to a height of 10-15 metres (33-50 feet). Many of them have in their trunks and branches large holes where Jackdaws (*Corvus monedula*), Barn Owls (*Tyto alba*) and Little Owls (*Athene noctua*) breed. Young Lynxes can also occasionally be found in them.

This group of habitats has the following settled fauna:

(1) Reptiles and mammals

(*In thickets of Halimium, Ulex and Genista*)

Greek Tortoise ( <i>Testudo graeca</i> )—in moist places near <i>juncigraminetum</i> where they feed	Polecat ( <i>Mustela putorius</i> )—rare
Grey Burrowing Lizard ( <i>Blanus cinereus</i> ) (plate 9 top)	Weasel ( <i>Mustela nivalis</i> )—rare
Ocellated Lizard ( <i>Lacerta lepida</i> )	Fox ( <i>Vulpes vulpes</i> )
Algerian Sand Lizard ( <i>Psammodromus algirus</i> )	Genet ( <i>Genetta genetta</i> )
Spine-foot Lizard ( <i>Acanthodactylus erythrurus</i> )	Mongoose ( <i>Herpestes ichneumon</i> )
Sand Skink ( <i>Chalcides bedriagae</i> )	Wild Cat ( <i>Felis sylvestris</i> )
Ladder Snake ( <i>Elaphe scalaris</i> )	Lynx ( <i>Lynx pardina</i> )
Southern Bordeaux Snake ( <i>Coronella girondica</i> )	Garden Dormouse ( <i>Eliomys quercinus</i> )
Montpellier Snake ( <i>Malpolon monspessulana</i> )	Black Rat ( <i>Rattus rattus frugivorus</i> )
Lataste's Viper ( <i>Vipera latastei</i> )	Mouse ( <i>Mus musculus</i> )—?
Hedgehog ( <i>Erinaceus europaeus</i> )	Long-tailed Field Mouse ( <i>Apodemus sylvaticus</i> )
	Hare ( <i>Lepus europaeus granatensis</i> ) —very rare
	Rabbit ( <i>Oryctolagus cuniculus</i> )
	Red Deer ( <i>Cervus elaphus</i> )
	Wild Boar ( <i>Sus scrofa</i> )

## (2) Birds

(In *Halimium-Ulex dense thicket*)

Red-legged Partridge ( <i>Alectoris rufa</i> )	Magpie ( <i>Pica pica</i> )
Great Spotted Cuckoo ( <i>Clamator glandarius</i> )—?	Sardinian Warbler ( <i>Sylvia melanocephala</i> )—rare
Red-necked Nightjar ( <i>Caprimulgus ruficollis</i> )	Dartford Warbler ( <i>Sylvia undata</i> )

(In *Halimium thicket, less dense or open*)

Red-legged Partridge ( <i>Alectoris rufa</i> )	Stone Curlew ( <i>Burhinus oediconemus</i> )
--	--

(In the cleared strips resembling forest "fire-breaks", where the shrubs have been cut down for sporting purposes, the Stone Curlew and also the Thekla Lark (*Galerida theklae*) find suitable habitats. Of the *Halimium* birds mentioned, the Red-legged Partridge, Magpie and Great Spotted Cuckoo, and Sardinian Warbler are practically absent from the interior *Halimium* zone.)

(In *Rubus-Erica thickets*)

Red-necked Nightjar ( <i>Caprimulgus ruficollis</i> )	Sardinian Warbler ( <i>Sylvia melanocephala</i> )
Stonechat ( <i>Saxicola torquata</i> )	Dartford Warbler ( <i>Sylvia undata</i> )—rare, as they prefer the <i>Halimium</i>
Nightingale ( <i>Luscinia megarhynchos</i> )	Great Grey Shrike ( <i>Lanius excubitor</i> )
Melodious Warbler ( <i>Hippolais polyglotta</i> )	

(In some moist places in the dense thicket, the Spectacled Warbler (*Sylvia conspicillata*) also nests in this habitat, though at the moment it is known only at two localities.)

## (3) Reptiles, mammals and birds of the cork oaks

(Cork oaks are the only trees of this zone and are sufficiently few to ensure that almost all trees carry nests, reptiles or mammals.)

Wall Lizard ( <i>Lacerta bocagei</i> )	Kestrel ( <i>Falco tinnunculus</i> )
Garden Dormouse ( <i>Eliomys quercinus</i> )	Woodpigeon ( <i>Columba palumbus</i> )
Lynx ( <i>Lynx pardina</i> )	Great Spotted Cuckoo ( <i>Clamator glandarius</i> )
Bats ( <i>Pipistrellus</i> , etc.)—probably	Barn Owl ( <i>Tyto alba</i> )
Heron ( <i>Ardea cinerea</i> )	Little Owl ( <i>Athene noctua</i> )
Little Egret ( <i>Egretta garzetta</i> )	Green Woodpecker ( <i>Picus viridis</i> )
Cattle Egret ( <i>Ardeola ibis</i> )	Golden Oriole ( <i>Oriolus oriolus</i> )
Night Heron ( <i>Nycticorax nycticorax</i> )	Jackdaw ( <i>Corvus monedula</i> )
White Stork ( <i>Ciconia ciconia</i> )	Magpie ( <i>Pica pica</i> )
Imperial Eagle ( <i>Aquila heliaca</i> )	Great Tit ( <i>Parus major</i> )
Booted Eagle ( <i>Hieraëtus pennatus</i> )	Great Grey Shrike ( <i>Lanius excubitor</i> )
Buzzard ( <i>Buteo buteo</i> )	Woodchat Shrike ( <i>Lanius senator</i> )
Kite ( <i>Milvus milvus</i> )	
Black Kite ( <i>Milvus migrans</i> )	

(Of these species, the egrets and herons are found breeding only at Algaida, where in any case only a small percentage of the nests are in the cork oaks, the majority being in the tree-heath and bramble.)

From this review it can be seen that the avifauna of the *Halimium* zone is very poor. But where the trees appear and the moist hollows give rise to thickets of bramble, tree-heath and so forth the fauna is considerably enriched, especially on the fringes of the *marismas*. There is, in fact, a long belt parallel with the *marismas* edge which is much richer than the rest of the *Halimium* zone and it is there that the greater part of the winged and terrestrial predators live.

*Grasslands and juncigraminetum along the marisma edge.*

The transition from the *Halimium* to the *marisma* is marked by a variable narrow belt of grasslands, as indicated in Fig. 4 (and in plate 1 right; also *antea* 77 upper and 78 bottom). It is possible to distinguish the following:

- (a) A strip of bracken (*Pteridium aquilinum*) along the ridge and upper slopes.
- (b) An arid grassland dominated by asphodel (*Asphodelus*) and camomile (*Anthemis fuscata*); in some parts of the Coto, especially by the lagoons in the interior, this zone is replaced by belts of sand, either naked or covered with various grasses and dotted with xerophile rushes (*Juncus*).
- (c) A very green and moist low-lying belt of grasses (mostly Bermuda grass, *Cynodon dactylon*, and wild barley, *Hordeum murinum*) and *Juncus*—together forming a *juncigraminetum*—which passes much of the year under water.

Each of these zones has a different fauna:

## (1) Fauna of the bracken strip

This includes some brambles and cork oaks, and its fauna is almost identical with that of the *Rubus-Erica* thickets already described. The most significant birds of the bracken area are, however, the following:

Stonechat ( <i>Saxicola torquata</i> )	Melodious Warbler ( <i>Hippolais</i>
Nightingale ( <i>Luscinia megarhynchos</i> )	<i>polyglotta</i> )

(2) Fauna of the arid prairie with *Asphodelus* and *Anthemis*

Lapwing ( <i>Vanellus vanellus</i> )	Short-toed Lark ( <i>Calandrella cinerea</i> )
Bee-eater ( <i>Merops apiaster</i> )	

(3) Fauna of the *juncigraminetum*

Quail ( <i>Coturnix coturnix</i> )	Fan-tailed Warbler ( <i>Cisticola</i>
Savi's Warbler ( <i>Locustella luscinioides</i> )	<i>juncidis</i> ) (plate 2)
	Yellow Wagtail ( <i>Motacilla flava</i> )

The importance of this zone as a hunting area for the birds of prey calls for more extended notice. It is here also that the Fallow Deer live and the Wild Boars come every night to search for herbs and worms.

*The "edge effect" on the birds of prey.*

From an ecological standpoint it is interesting to study the factors which make the Coto one of the richest areas for birds of prey, and to see how these birds of prey, with few exceptions, concentrate in the zone fringing the *marismas*. The birds of prey occurring there in relatively high densities are:

- Imperial Eagle (*Aquila heliaca*)—every pair seems to include an area of *juncigraminetum* in its hunting territory  
 Kite (*Milvus milvus*)—tied to this zone  
 Black Kite (*Milvus migrans*)—also tied to the *juncigraminetum*  
 Buzzard (*Buteo buteo*)—the majority have territories on the *juncigraminetum*  
 Booted Eagle (*Hieraëtus pennatus*)—generally hunts over the *juncigraminetum* (but see footnote on page 14)

The only species which generally never hunts along the fringe of the *marisma* is the Short-toed Eagle. The Kestrel hunts a little everywhere at a low density, but is not much interested in the *juncigraminetum* as a hunting area.

The fact that the abundant trees all along the *marisma* fringe provide nesting sites has undoubtedly a great influence on the concentration of birds of prey in that zone. But the principal reason for that concentration is unquestionably the abundance of prey in the *juncigraminetum* and *Anthemis* and *Asphodelus* grasslands together with the bracken on the banks and the neighbouring *Halimium*.

Fig. 6 represents the fringe of the *marisma*, with a little island (*veta* in Spanish), the *Carex-Scirpus* zone (sedges and bulrushes) and the adjoining dry-land habitats. Symbols indicate the animals most important in the diet of the birds of prey. It may be noted that:

- (a) In the interior, amid the dry *Halimium*, the biocenosis is simple. At lower levels it is characterized by the abundance of the small lizards (*Acanthodactylus* and *Psammodromus*) and of their reptilian predators, the Ocellated Lizards (*Lacerta lepida*) and certain snakes—*Malpolon*, *Elaphe*, *Coronella giroudica* (Southern Bordeaux Snake) and some *Vipera*. The density of birds of prey is low here: only the Short-toed Eagle occupies a clear place in the biocenosis.
- (b) On the *marisma* fringe the population of potential prey species goes up vertically. These include:
  - (i) Southern Mud-Frog (*Pelobates cultripes*)—hatched by thousands in the *marismas* they pass on to the Coto across the fringing grasslands, which are also the favourite foraging area for the young. They flee across the sands on dry land, or live in crevices of the clay in the dried-up *marisma*. On the occasion of a plague (due possibly to parasitism by some species of green-bottle fly, *Lucilia*), I have been able to count the corpses of 54 individuals on 16 sq. metres (19 sq. yards), equivalent to a density of some 342 frogs in a square with sides of 10 metres (11 yards) each. This frog is the dietary base for the Water Snakes (*Natrix maura*), Brown Rats (*Rattus norvegicus*) and certain of the herons, and, in addition, Black Kites, Barn Owls, etc. Frogs and their minor predators, snakes and rats, form the dietary base of the kites and probably of other birds of prey. Pleurodele Newts (*Pleurodeles waltli*) are also very common in normal (not dry) years.
  - (ii) Water Vole (*Arvicola terrestris*)—infrequent or rare; tied to this zone.
  - (iii) Mediterranean Pine Vole (*Pitymys duodecimcostatus*)

Ocellated Lizard (*Lacerta lepida*)

Small lizards

▲ Southern Mud-Frog (*Pelobates cultripes*)

● Water Snake (*Natrix maura*)

● Pine Vole (*Pitymys duodecimcostatus*)

⊙ Long-tailed Field Mouse (*Apodemus sylvaticus*)

● Rats and Water Voles (*Rattus and Arvicola*)

♡ Rabbit (*Oryctolagus cuniculus*)

∩ Marsh-birds

○ Eggs

∩ Island-birds

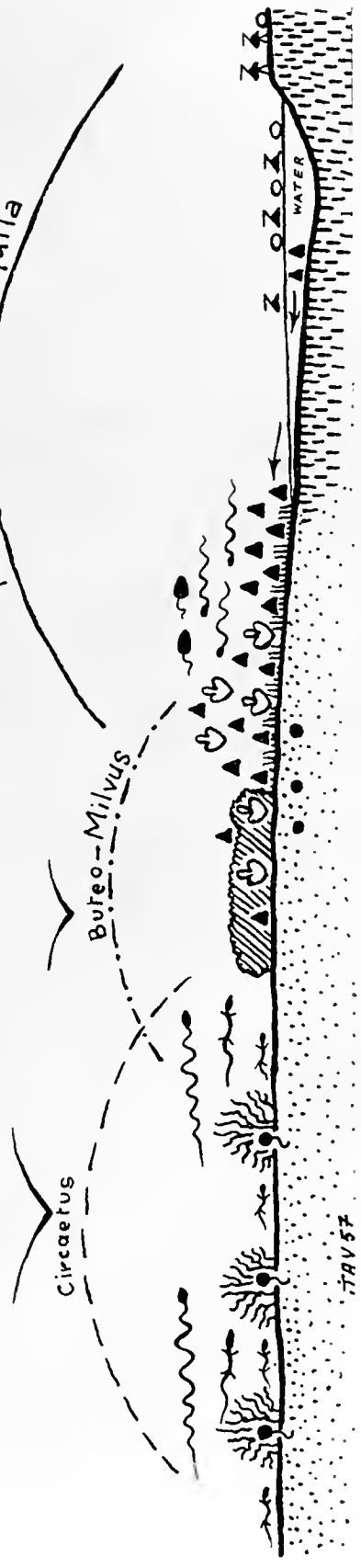

Halimium — Pteridium — graminetum — Carex-Scirpus — Veta

FIG. 6—DIAGRAMMATIC SKETCH OF DISTRIBUTION OF BIRD PREDATORS AND THEIR MAIN PREY IN FIVE MAIN HABITATS ACROSS THE SANDY PLAINS AND THE MARISMAS

This shows the hunting zones and foods of Short-toed Eagle (*Circus*), Buzzard (*Buteo*), kites (*Milvus*), hawks (*Circus*) and eagles (*Aquila*) and illustrates the "edge effect" on the birds of prey (see pages 11-15).

—common, in places, on dry ground fringing the *marisma*; well known as a prey of raptors.

- (iv) Rabbit (*Oryctolagus cuniculus*)—the greatest concentrations of Rabbits on the Coto always correspond to a *juncigraminetum*. They are extremely abundant the whole length of the *marisma*. Reproducing themselves up among the bracken in dry conditions the young haunt the grasslands where they are easily captured by such birds of prey as the Imperial and Booted Eagles, the two Kites and doubtless the Marsh Harrier (*Circus aeruginosus*). This fact makes the fringe a favourite hunting ground.
- (v) Long-tailed Field Mouse (*Apodemus sylvaticus*) and Garden Dormouse (*Eliomys quercinus*)—are generally distributed through the *Halimium*, but are perhaps more abundant in the marginal zone among the cork oaks.
- (c) Water birds are extremely common on the *marismas* and the *vetas*. The birds of prey of the fringe (except the Buzzard, which is replaced here by the more competitively fitted Marsh Harrier) hunt the whole length of the *marisma* to an average of 3-4 km. (about 2-2½ miles) in from the margin. The most devoted to this type of hunting are the two Kites and the Imperial Eagle who take a number of young, but (in the first two instances) do particular damage in gorging themselves on eggs. Ravens (*Corvus corax*) readily join in, being formidable predators of other birds. A few pairs of Barn Owls seem to specialize in taking birds on the *marismas*.

Nearly all the above applies also on the shores of the large or small lagoons of the interior. It is on these lagoons as well as the edge of the *marismas* that the birds of prey concentrate. It must also be remembered that several birds—the Magpie, Great Spotted Cuckoo, Jackdaw, Spotless Starling (*Sturnus unicolor*), Green Woodpecker, small Passerines, etc., are missing from the *Halimium* of the interior and the rare cork oaks of that arid zone (see pages 9-10). They accordingly contribute with a fairly strong concentration along the fringe to the diet of the birds of prey there.

Unquestionably the bird of prey most favoured by this abundant food supply is the Black Kite (shown in plate 7 lower, where one is at a carcass with Griffon, *Gyps fulvus*, and Egyptian Vultures, *Neophron percnopterus*). During the past few years of absolute protection this species has multiplied, while the others maintain a more stable population\*. The great concentration of

\*One bird of prey does seem to have become steadily much scarcer on the Coto during the last 50 years, and that is the Booted Eagle. This is possibly a result of the almost total disappearance of the white poplar (*Populus alba*), the tree in which it used most frequently to nest.



Black Kites along the edge of the *marisma* used to make this the chosen area for the massacres of young which formerly took place, and as soon as these massacres ceased their population increased at a substantial rate.

Perhaps the greatest concentrations of Black Kites on the Coto are those to be found at the mouth of the Guadalquivir. Though they are not protected by the owners of that part of the Coto Doñana sand-bar (Las Marismillas), some 30-50 Black Kites can normally be seen over the river. The reason for this is the great number of dead fish (*Carassius carassius*) that lie along the edges of the river. These fresh-water fish live abundantly in the *caños* (fresh-water channels) of the *marismas* and many that approach too close to the river are killed by the salt water every day when the tide rises. Multitudes of corpses lie on the muddy banks and kites, gulls and Wild Boars come to feed on them. According to the fishermen, 5 or 6 tons of dead fish are received each day in Sanlucar, to be used as fertilisers. No doubt this attractive food supply is responsible for the incessantly replenished population of Black Kites in that area, for many nests are destroyed every year there and their breeding-success in that part must be very low.

#### *The marismas.*

Two of the habitats listed earlier in this paper (see page 2), the *Carex-Scirpus* and the *Salicornia* zones, are those which form the *marismas*.

All along the edge of the Coto Doñana proper, and some 500-1,000 metres (550-1,100 yards) from it, inside the *marisma*, there flows from north-west to south-east a *caño*, or fresh-water stream. When the *marisma* is flooded, this channel is discernable only through the denser vegetation growing along it. This higher and thicker growth is made up of stands of *Typha* (reed mace) and *Phragmites* (water-reed) along the actual bed of the stream. This *caño* is called, in Spanish, "La Madre de las Marismas" ("The Mother of the Marismas") because it brings the greater part of the fresh water for them—or, alternatively, "La Madre del Rocio" (see map *antea* pp. 508-509).

In Fig. 5 the Madre is represented by a ribbon of *Typha* and *Phragmites*. The lowest zone on both sides of the Madre, which is flooded most of the year, is covered by a tall *Scirpus* (bulrush; *ballunco* in Spanish). And the shallower waters on each side are covered by a *Carex* (sedge; *castañuela* in Spanish), which occupies immense areas (see *antea* plates 70 lower and 78 top and centre).

The glasswort (*Salicornia fruticosa* and *Arthrocnemum macrostachyum*, with lesser amounts of *S. herbacea*) occupies the larger part of the *marisma* (plate 8 upper). It grows at a higher level, and accordingly in drier conditions (compare *antea* plate 70 upper with lower), than the *Carex-Scirpus*, and on ground possibly more saline, at a distance from the fresh water of the Madre. On

the banks of the Guadalquivir (see *antea* plate 71 left) it entirely replaces the *Carex-Scirpus*, but in the corner of the *marisma* near El Rocio it is not abundant. It grows on flat, dry, cracked, clay soil, and is very pale in colour.

Dotted over the whole extent of the *marisma* are little eminences which, when the *marisma* is flooded, form the little islands called *vetas* by the people of the region. They are in general of small area: the largest do not even reach a length of, say, 500 by 250 metres (550 by 275 yards), and the smallest are only a few tens of metres across.

Each *veta* is surrounded by a band of bare clay, followed by another covered with *Suaeda* (seablite; *sapina* in Spanish). The plateau of each island itself is covered with grasses, camomile (*Anthemis fuscata*) and thistles (*Silybum marianum* and *Cirsium arvense*), and here breed most of the ground-nesting birds (plate 8 lower): many of the *vetas* have large colonies of waders and terns.

The variations in water level over the *marismas* have a decisive importance for their population of breeding birds. In a normal year there are the following changes in the water level:

- January: The water covers the lower flats up to the height of the *Salicornia*. The water surface is nearly unbroken by plants, except for a few shoots of *Carex* piercing through. These, with the debris of the previous year's vegetation provide sites that permit the first Coots to nest (exceptionally in December).
- February: The *Carex* begins to emerge from the water in the shallowest parts. Coots build and lay in the growing clumps and in the *Salicornia*.
- March: *Carex* and *Scirpus* still do not cover all the surface of the *marisma*, but Coots can now nest almost everywhere.
- April: The *marisma* is covered with vegetation and many birds nest all over.
- May: The water begins to recede. On the *vetas* the herbage begins to dry up, permitting certain other birds to nest, e.g. Pratincoles.
- June: The water is still lower and the herbage of the *vetas* has shrivelled. The *Carex* and *Scirpus* begin in places to suffer from lack of moisture.
- July: Further fall of water level. The *Carex* starts to wilt, and dries out over large areas.
- August: There is no longer standing water except in certain spots, called in Spanish *lucios*. The *Carex* continues to collapse.
- September: In the course of this month the *marisma* is almost everywhere completely dry. The *Carex* is flat on the ground, except in places where it is dense enough to stand up in tufts. The earth is cracked. In the hollows the *Scirpus* keeps a little moisture, and the remaining birds concentrate there; the majority have departed.
- October: The first rains give rise to marshes. The debris of the summer vegetation is heaped up along the edges by the wind.
- November: There is more water. The surface of the marshes is unbroken, except by debris and except by some *Carex* and *Scirpus* which has avoided being flattened during the summer.
- December: The *marisma* is full of water. The wind has piled up the debris of vegetation on the shores. A few new shoots of *Carex* pierce the water surface, mingling with the dead material.

The *vetas* are clear of water even in January.

The impressive area of the *marismas* holds an equally impressive breeding population of countless thousands of birds of many species. The following are the main groups known to nest:

(1) Breeding in the *Carex-Scirpus*

Great Crested Grebe ( <i>Podiceps cristatus</i> )	White-headed Duck ( <i>Oxyura leucocephala</i> )*
Black-necked Grebe ( <i>Podiceps nigricollis</i> )	Marsh Harrier ( <i>Circus aeruginosus</i> )
Little Grebe ( <i>Podiceps ruficollis</i> )	Baillon's Crane ( <i>Porzana pusilla</i> )
Bittern ( <i>Botaurus stellaris</i> )	Moorhen ( <i>Gallinula chloropus</i> )
Red-crested Pochard ( <i>Netta rufina</i> )*	Coot ( <i>Fulica atra</i> )
Ferruginous Duck ( <i>Aythya nyroca</i> )*	Crested Coot ( <i>Fulica cristata</i> )
	Black Tern ( <i>Chlidonias niger</i> )
	Whiskered Tern ( <i>Chlidonias hybrida</i> )

\*nests reported by the keepers (*guardas*), but not yet independently verified.

(2) Breeding in the Madre, in *Typha-Phragmites*

Purple Heron ( <i>Ardea purpurea</i> )	Purple Gallinule ( <i>Porphyrio porphyrio</i> )
Night Heron ( <i>Nycticorax nycticorax</i> )*	Great Reed Warbler ( <i>Acrocephalus arundinaceus</i> )
Spoonbill ( <i>Platalea leucorodia</i> )*	

\*reported by the keepers, but nesting only in some years.

(3) Breeding on the *vetas*

Mallard ( <i>Anas platyrhynchos</i> )	Stone Curlew ( <i>Burhinus oedicephalus</i> )
Teal ( <i>Anas crecca</i> )	Pratincole ( <i>Glareola pratincola</i> )
Marbled Duck ( <i>Anas angustirostris</i> )	Slender-billed Gull ( <i>Larus genei</i> )
Garganey ( <i>Anas querquedula</i> )	Gull-billed Tern ( <i>Gelochelidon nilotica</i> )
Gadwall ( <i>Anas strepera</i> )	Little Tern ( <i>Sterna albifrons</i> )
Pintail ( <i>Anas acuta</i> )	Pin-tailed Sandgrouse ( <i>Pterocles alchata</i> )
Lapwing ( <i>Vanellus vanellus</i> )	Bee-eater ( <i>Merops apiaster</i> )
Kentish Plover ( <i>Charadrius alexandrinus</i> )	Short-toed Lark ( <i>Calandrella cinerea</i> ) (plate 11 lower)
Redshank ( <i>Tringa totanus</i> )	Yellow Wagtail ( <i>Motacilla flava</i> ) (of the Spanish blue-headed form, <i>iberiae</i> )
Avocet ( <i>Recurvirostra avosetta</i> )	
Black-winged Stilt ( <i>Himantopus himantopus</i> ) (plate 1 left)	

(4) Breeding on dry ground among the *Salicornia*

Montagu's Harrier ( <i>Circus pygargus</i> )	Short-toed Lark ( <i>Calandrella cinerea</i> )
Stone Curlew ( <i>Burhinus oedicephalus</i> )	Lesser Short-toed Lark ( <i>Calandrella rufescens</i> )
Pin-tailed Sandgrouse ( <i>Pterocles alchata</i> )	Yellow Wagtail ( <i>Motacilla flava</i> )
Calandra Lark ( <i>Melanocorypha calandra</i> )	

A dry year, like 1957, means the disappearance of the water bird population (a typically desolate dry *marisma* scene is shown in plate 12 left). Most of the birds of the *vetas* do not nest. The breeding population is reduced to little more than the Pratincoles, Lapwings and Black-winged Stilts, and the *Typha-Phragmites* species; the birds of the dry *Salicornia* colonize zones where they are not seen in normal years.

Mammals and reptiles join the birds of prey already mentioned in their depredations on the *marisma* fauna. Montpellier Snakes can be seen on the *vetas*, gorged with eggs and chicks. Foxes and rats establish themselves in the *vetas* in Rabbit holes near the

edge of the *marisma*. Wild Boars penetrate annually to the *vetas* and eat practically nothing but eggs and young birds.

Here is a census of the bird population of a *veta*, Los Paciles Cortados, on 14th June 1956, made with binoculars shortly before sunset, counting birds on the ground, brooding or beside their chicks. This *veta* is about 500 metres long by 100 metres wide (550 yards by 110 yards).

Lapwing ( <i>Vanellus vanellus</i> )	...	...	...	6 pairs
Kentish Plover ( <i>Charadrius alexandrinus</i> )	...	...	...	20 "
Redshank ( <i>Tringa totanus</i> )	...	...	...	6 "
Avocet ( <i>Recurvirostra avosetta</i> )	...	...	...	15 "
Black-winged Stilt ( <i>Himantopus himantopus</i> )	...	...	...	30 "
Pratincole ( <i>Glareola pratincola</i> )	...	...	...	300 "
Gull-billed Tern ( <i>Gelochelidon nilotica</i> )	...	...	...	6 "
Little Tern ( <i>Sterna albifrons</i> )	...	...	...	10 "
Short-toed Lark ( <i>Calandrella cinerea</i> )	...	...	...	6 "
Yellow Wagtail ( <i>Motacilla flava</i> )	...	...	...	6 "

A census made in March would show only a few Mallard, a few pairs of Lapwings and Black-winged Stilts, and by the end of the month some Avocets and Redshanks. The latest to lay are the terns.

It seems that the high ground temperatures of the *vetas*, lacking in vegetation cover to give protection against the strong sun, oblige the birds to adopt special nesting sites. Pats of cowdung, which provide good insulation, are a favourite site of the Pratincole. The Kentish Plover's eggs are slightly shaded between lumps of dry mud. The Short-toed Lark usually builds beside a plant which shades the eggs during part of the day, and often places a ramp of particles of mud along the open side of the nest. These adaptations are similar to those observed in the desert.

The enemies of birds breeding on the *vetas* are so numerous that many clutches are lost, and repeat clutches are laid in replacement. When the greater part of the breeding population has left and the *vetas* used as nesting colonies are becoming deserted, a number of pairs still without nests gather to these places, and pairs which have lost their clutches lay a second, third or fourth. Close to habitations, eggs are collected systematically on some of the *vetas*. Adult populations are maintained during the laying of repeat clutches, and these populations act as a magnet for late breeders who come and join them. The *veta* covered by the census given above is one of those which suffer most from such exploitation, and consequently breeding on it continues when it is more or less finished elsewhere on the *marisma*.

#### *The herons of the Coto Doñana.*

The heron colony of the Coto Doñana, one of the largest in Europe, reaches at its strongest a population of about 30,000 birds, including both adults and young, about the end of June or the beginning of July. This surprising heron concentration is of great ecological interest.

Despite several shifts during the past 25 years the heronry seems to be preferably located in the thickets of tree-heath and bramble and in the adjoining cork oaks in moist hollows at least 1 kilometre (1,100 yards) from the *marisma* edge (see plate 6 lower; also *antea* plates 73-76).

This widespread colony is composed of Little Egrets (*Egretta garzetta*), Cattle Egrets (*Ardeola ibis*), Night Herons (*Nycticorax nycticorax*), Squacco Herons (*Ardeola ralloides*), Common Herons (*Ardea cinerea*) and White Storks (*Ciconia ciconia*). Each species has a favourite nest site: the White Storks and Common Herons nest in the higher cork oaks; Little Egrets and Night Herons can nest high in the trees but the great majority nest in the thickets; the Cattle Egret sometimes nests in the trees but much prefers the thicket, and the Squacco Heron nests only in the thicket.

This concentration of birds would be difficult to explain if there were active food competition between the different species of herons composing the colony. However, study of the diets of the different species shows that the competition is slight between them. Also, the colonial foraging range is enormous. The Little Egret, Cattle Egret and Night Heron can cover a radius of about 25 kilometres (15 miles) between the nest and the feeding area. The Squacco Heron goes less far, but covers more than 10 kilometres (6 miles) afield. Thus, the Squacco Herons from the Algaida colony have their main feeding territory near El Rocio, while the other small herons hunt all over the *marisma* and even along the banks of the Guadalquivir, as is proved by the discovery, in the stomachs of nestlings, of fishes—grey mullet (*Mugil*) and silver-sides (*Atherina*)—which do not live in the *marisma*.

The following basic diets are consumed by the different species of herons:

- Cattle Egret: Eats grasshoppers, beetles, spiders and larvae of Neuroptera (lace-wings, etc.) and other insects; also vertebrates such as the Marsh Frog (*Rana ridibunda*), the Tree Frog (*Hyla arborea*) and the Spine-foot Lizard, but very few fishes.
- Little Egret: The plump *Carassius*, a very abundant fish of the *marismas*, and the little *Gambusia* form the mainstay (*Gambusia* has been introduced to Spain only recently to control mosquito larvae). Many aquatic insects are also taken.
- Night Heron: Eats mainly the fish *Carassius*, Mud Frogs (*Pelobates*), the Pleurodele Newt (*Pleurodeles waltli*) and eels (*Anguilla anguilla*).
- Squacco Heron: Eats fish and aquatic insects.

### *The fresh-water lagoons.*

Across the Coto Doñana a series of fresh-water lagoons stretch roughly from east to west. They are considered to be vestiges of an old arm of the Guadalquivir which flowed out into the Atlantic across the Coto. These lagoons are called (from east to west) Sopeton, Las Pajas, Santa Olalla, Laguna Dulce, El Taraje, El Saillo and El Charco del Toro. Beginning with Santa Olalla they

lie along the line separating the pinewoods from the *Halimium* plain, so that each lagoon has on one side pines and on the other thicket or heath. They are bordered with a band of *juncigraminetum* of varying width (plate 9 bottom).

The largest lagoon is Santa Olalla. About fifty years ago it was probably more saline than now, since *Atherina* (silversides fish) and crustaceans have died out in its waters since that time. The other lagoons, overwhelmed by sand transported by the wind from the beach, are in process of disappearing. They seem to have shrunk appreciably during the last fifty years.

Sopeton and Santa Olalla do not dry up in summer, or at least do so only exceptionally. The others undergo great fluctuations in water level in the course of the year, and are often dry in August-September.

The surface vegetation is poor. In Sopeton (plate 9 centre) there are only sparse *Scirpus* (bulrush) plants. Laguna Dulce has three large clumps of *Typha* (reed-mace) and *Phragmites*, whose situation is shown in Fig. 3. Similar clumps exist also in El Saillo and El Charco del Toro (*antea* plate 77 lower). Santa Olalla and El Taraje are bare.

The following is the fauna of the fresh-water lagoons:

(1) Batrachians, reptiles and fish

Pleurodele Newt ( <i>Pleurodeles waltli</i> )	European Pond Tortoise ( <i>Emys orbicularis</i> )
Southern Mud-Frog ( <i>Pelobates cultripes</i> )	Water Snake ( <i>Natrix maura</i> )
Tree Frog ( <i>Hyla arborea</i> )	... ..
Marsh Frog ( <i>Rana ridibunda</i> )	Common Eel ( <i>Anguilla anguilla</i> )
Natterjack Toad ( <i>Bufo calamita</i> )	Fish— <i>Carassius carassius</i>
... ..	<i>Gambusia holbrocki</i> —in
Spanish Terrapin ( <i>Clemmys leprosa</i> )	Sopeton only

(2) Birds

Great Crested Grebe ( <i>Podiceps cristatus</i> )	Red-crested Pochard ( <i>Netta rufina</i> )
Black-necked Grebe ( <i>Podiceps nigricollis</i> )	Ferruginous Duck ( <i>Aythya nyroca</i> )
Little Grebe ( <i>Podiceps ruficollis</i> )	White-headed Duck ( <i>Oxyura leucocephala</i> )
Purple Heron ( <i>Ardea purpurea</i> )	Moorhen ( <i>Gallinula chloropus</i> )
Mallard ( <i>Anas platyrhynchos</i> )	Coot ( <i>Fulica atra</i> )
Marbled Duck ( <i>Anas angustirostris</i> )— in the lagoons of las Marismillas, and perhaps Sopeton	Crested Coot ( <i>Fulica cristata</i> )

Probably the Pochard (*Aythya ferina*) should be added to the above list, but we have no proof of its nesting. The lagoon of Sopeton, which is in communication with the *marisma*, is a past breeding site of Whiskered and Black Terns (*Chlidonias hybrida* and *niger*).

At the lagoon of El Taraje a big colony of egrets and herons (*Egretta*, *Ardeola* and *Nycticorax*) was established towards the end of the 19th century, but it ceased to exist about 1920. The

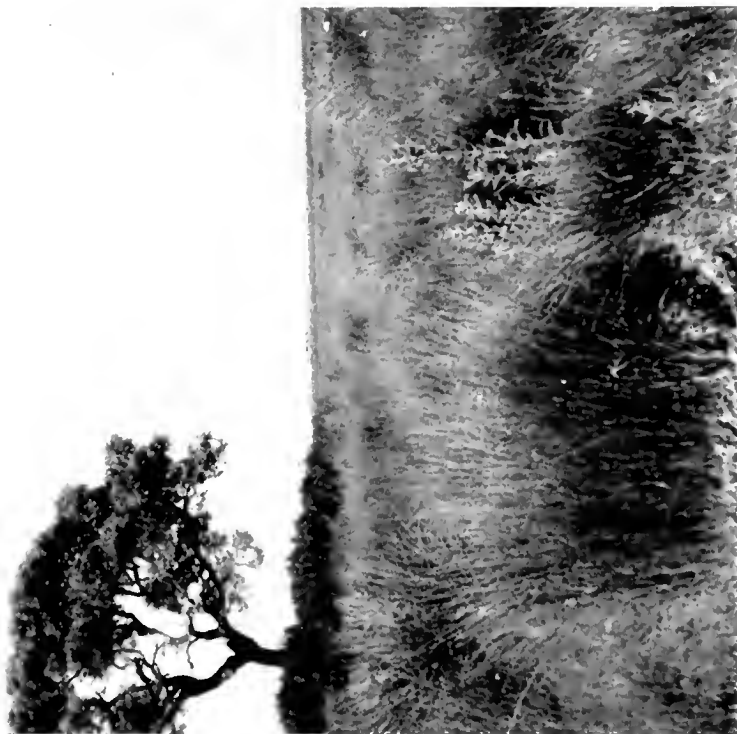

Eric Hosking

## CORK OAK, BRACKEN AND JUNCUS

COTO DOÑANA, MAY 1956 AND 1957

The Stilt is the predominant *marisma* wader, nesting chiefly on the islands and among tussocks of *Salicornia* (here mixed with wild barley, *Hordeum*) on slight eminences of mud. This shows a half-complete clutch in a typically substantial *marisma* nest. The other photograph shows the *marisma* edge of the sandy plateau, with bracken (*Pteridium*) on the upper slope, then a zone of xerophile rushes (*Juncus*)—here filling the foreground—and, beyond, the low-lying belt of grasses forming the *juncigraniticum* (see page 11).

## BLACK-WINGED STILT AT NEST





Eric Hosking

FAN-TAILED WARBLER AT NEST: COTO DOŠANA, MAY 1957

This, the smallest European warbler, is found in low-lying country from dry cornfield and rough grass to marshland. On the Coto, however, it is essentially a bird of the *marisma* edges and a typical species of the *juncigraminetum* (see page 11) sharing the *Juncus* clumps as nest-sites with far fewer Savi's Warblers. Its high, penetrating song-note *zeep . . . zeep . . . zeep* is a characteristic sound of these areas. This slender nest of gossamer and seed-heads was in some strands of *Carex* sedge in the midst of *Juncus*, and was  $8\frac{1}{2}$  inches from top to bottom, with the entrance nearly  $5\frac{1}{2}$  inches up.





Eric Hosking

MALE SHORT-TOED EAGLE AT NEST: COTO DOÑANA, MAY 1957

This handsome grey-brown and white eagle with remarkably penetrating orange eyes is not common on the Coto, but its ecology is interesting. It feeds exclusively on the snakes of the region (*Elaphe*, *Malpolon*, *Cornella*, *Natrix*) and on the big Ocellated Lizards (see Fig. 6 on page 13), so that it does not need the massive flesh-tearing bill of the mammal-eating eagles (cf. plate 7 upper); its head indeed is more like that of the harriers, to which it is more closely related. This youngster was only about 20 days old, but it could swallow a 2½-ft. snake (diam. 1½ ins.) in 37 minutes, almost whole.



*Eric Hosking*

HABITAT OF SHORT-TOED EAGLE: COTO DOÑANA, MAY 1957

The nest on plate 3 was 24½ feet up in the foreground pine. In this area behind the coastal dunes small birds are few—Goldfinch, Serin, Orphean Warbler.



*Eric Hosking*

PARTIALLY STABILIZED COASTAL DUNES: COTO DOÑANA, MAY 1957

A view taken from the Short-toed Eagle's nest, showing junipers, stunted pines, *Halimium*, marram grass and sea behind; snakes and lizards are common.



*Eric Hosking*

"OASIS" AMONG THE COASTAL DUNES: COTO DOÑANA, MAY 1957

Only two species, Stone Curlew and Heckla Lark, nest in these hollows between the dunes (see page 3), but in spring they form a resting-place for tired migrants from Africa and the tiny pines become alive with birds.



*B. W. Tucker*

"PARK-LAND" WITH CORK OAKS AND HALIMIUM: COTO DOÑANA, APRIL 1935  
 Concentration of raptors near *marisma* edge (pages 11-14)—the trees in this picture held nests of Booted Eagle, Kite, Black Kite and Buzzard.



*Eric Hosking*

ISOLATED STAND OF PINES ON HALIMIUM PLAIN: COTO DOÑANA, MAY 1956  
 Such clumps are a feature of the plain (see page 6). The *Halimium* scrub, up to 5 feet high, almost conceals the two horses on the right.



*Eric Hosking*

CHARCOAL-BURNING, THE FINISHED PRODUCT: COTO DOÑANA, MAY 1957  
 Charcoal-burners affect the pinewood habitats in two ways, by stripping the trees of all but the topmost branches, and by temporarily destroying the ground vegetation—better for Red-necked Nightjars, but less good for warblers.



*Eric Hosking*

PALACIO DE DOÑANA FROM PINAR DE SAN AGUSTIN; COTO DOÑANA, MAY 1957  
Note the bare tree-trunks (see plate 5 bottom). This pinewood is the haunt of several Red-necked Nightjars, and characteristic of the scrub beyond are Dartford Warbler, Magpie and Great Spotted Cuckoo. Around the Palacio is a eucalyptus grove with Golden Orioles, many Goldfinches and little else (see page 22).



*Eric Hosking*

A TREE-NESTING PART OF THE GREAT HERONRY; COTO DOÑANA, MAY 1956  
The Common Herons and White Storks, and a very few of the Little Egrets and Night Herons, breed in the cork oaks (see page 16). Here there are three Storks, seven Little Egrets and three brooding Night Herons (two just visible below the upper Storks, and the third to the right of the lower one).



Eric Hosking

IMPERIAL EAGLE BRINGING FOOD TO YOUNG: COTO DOÑANA, MAY 1957

Note the massive flesh-tearing bill (*cf.* plate 3); Hares and Rabbits are among its main prey, but it also feeds on birds and other mammals, including any found freshly dead. The size of a Golden Eagle, dark brown with white "shoulders", it nests in the crowns of pines, as here, or the tops of cork oaks.



Eric Hosking

THREE CARRION-FEEDERS AT A DEER CARCASE: COTO DOÑANA, MAY 1957

Left to right: Black Kite, Egyptian Vulture, Griffon. The last two, though numerous, do not nest on the Coto, but the Black Kite is the commonest breeding raptor there, both in the pines and the cork oaks. Its greatest concentrations are along the *marisma*-fringe where nest-sites and food are plentiful (see pages 14-15).



*Eric Hosking*

THE SALICORNIA ZONE AND SHALLOW FLOODING: COTO DOÑANA, MAY 1956  
*Salicornia* covers much of the *marismas*. It grows at a higher level than the *Carex-Scirpus* and is dry for most of the year, forming a breeding-ground for Montagu's Harrier, Stone Curlew, three species of lark, and Yellow Wagtail (see page 17). A Yellow Wagtail's nest was being examined here.



*Eric Hosking*

THE EDGE OF A VEGA: COTO DOÑANA, MAY 1956  
The *petas* (or islands) are always dry, and so have a distinct flora of grasses, camomile and thistles (where the white mule is, on the right). The change from the *Salicornia* zone to a strip of *Suaeda* is usually marked by a band of bare clay (see pages 16-17). The hide was by a Pratincole's nest.



*Eric Hosking*

GREAT GREY SHRIKE BRINGING FOOD TO YOUNG: COTO DOÑANA, MAY 1957  
 The nest is in a pistachio (see pages 7-8) and the bird has a Grey Burrowing Lizard (*Blanus cinereus*), a legless creature.



*Eric Hosking*

SOPETON, ONE OF THE SMALLER LAGOONS: COTO DOÑANA, MAY 1957  
 Sparse bulrush (*Scirpus*) forms the only emergent vegetation, but Little Grebe, Coot, Ferruginous Duck and Red-crested Pochard breed here.



*Eric Hosking*

JUNCIGRAMINITUM AT EDGE OF SANTA OLEIVA: COTO DOÑANA, MAY 1959  
 This is by far the largest of the Coto's line of seven lagoons, but it has no surface vegetation (see page 20). It is the haunt of White-headed Duck and many migrant waders and terns.



Eric Hosking

FLORA OF PARTIALLY STABILIZED SAND-DUNES: COTO DOŠANA, MAY 1957

This illustrates the Coto's dominant shrub, the pale-coloured *Halimium* with its striking yellow flowers, and also the grass *Ammophila australis*. Thekla Larks, Stone Curlews, snakes, lizards and tortoises make up the vertebrate fauna of this zone (see page 3).



Eric Hosking

EDGE OF MARISMAS NEAR LICIO DEL MEMBRILLO: COTO DOŠANA, MAY 1957

In the south the *Halimium* plain is absent, and this illustrates (apart from the inevitable horse and mules transport) a typical meeting of the pine-woods, marismas and naked dunes, with a *Juncus* zone in the middle distance. These pines hold Azure-winged Magpies (see plate 11 upper).





Eric Hosking

AZURE-WINGED MAGPIE AT NEST; COTO DOÑANA, MAY 1957

This beautiful black-capped, brownish-grey bird with blue wings and long blue tail has colonized the Coto within the last 50 years, with the development of the pinewoods, its preferred habitat. Only two-thirds the size of our Magpie, it builds an undomed nest of pine twigs, lined with mammal hair.



Eric Hosking

SHORT-TOED LARK AT NEST; COTO DOÑANA, MAY 1957

This and the Lesser Short-toed are the predominant larks of the *marismas*. The Short-toed, distinguished by rufous colouring, dark neck-patches and unstreaked breast from its greyer-brown relative, was found chiefly where the *Salicornia* was sparse, the Lesser Short-toed where it was more plentiful. Most nests are by *Salicornia* with a ramp of mud particles on the open side (see page 18).



DRY MARISMAS AND STUNTED VEGETATION

COTO DOŠANA, MAY 1957

On the left is a desolate scene typical of one type of dry *marisma*—parched, cracked clay with very sparse, pale *Salicornia* and other vegetation—the home of little apart from Short-toed Larks and Lapwings, though Pratincoles and Kentish Plovers were breeding in the middle distance. The right-hand photograph shows a stand of 10-foot tree-heath (compare with the walking stick, bottom right). This *Erica arborea*, interlaced with bramble (*Rubus*), forms dense, almost impenetrable thickets that are the haunt of Nightingale, Melodious and Sardinian Warblers, Great Grey Shrike, Stonechat and Lynx (see pages 9-10).



*E. M. Nicholson*

TREE-HEATH AND BRAMBLE THICKET

Glossy Ibis (*Plegadis falcinellus*)—of which only a few non-breeding birds are now to be seen in the *marismas*—used to nest there.

The importance of these lagoons as a refuge for the birds of the *marismas* during the summer, when their habitats are dried up, must not be exaggerated. It is true that young Coots displaced from the desiccated *marisma* concentrate on the lagoons, but the number of birds finding refuge in this way is insignificant compared with the great masses hatched on the *marismas*. Only for the White-headed Duck, Marbled Duck and Purple Heron have the lagoons a certain importance as refuges. For the first, which breeds at Las Nuevas in the extreme east of the *marismas* and a little elsewhere throughout the delta, the lagoons represent an occasional nesting place, but probably none bred in 1957 and very few in preceding years. The status of the Marbled Duck is similar, but even less definite.

Laguna Dulce forms the only remaining nesting stronghold of Purple Herons in the *marisma* region, except for a few isolated pairs breeding in clumps of *Typha* and *Phragmites* in the Madre and in a few *caños* very remote from the Coto, near the Guadalquivir, which we have not visited.

#### *The human environment.*

The influence of man on the environment is manifest above all in the reforestation by pines—and now by eucalyptus which bring about a rapid loss of fauna. Compared with the great faunistic richness of the old habitats of *Halimium* and cork oak, and the pinewoods, the eucalyptus plantations are noteworthy for their extreme poverty of fauna. About the only species which maintain or adapt themselves within the eucalyptus plantations are Stone Curlews, Kestrels, Bee-eaters, Thekla Larks, Golden Orioles and Goldfinches. A few Red-legged Partridges are also seen. Only the Red Deer and some reptiles such as the lizard *Acanthodactylus* (a species replaced in the thickets by *Psammmodromus*) seem to prefer the new habitat. The disappearance from the new plantations of the Imperial Eagle, Lynx, etc., has been conspicuous.

Agriculture has little importance on the Coto. At the western end an appreciable area is occupied by cereals and *guayules*\* (these last being quite new in the region). In the first occur the obvious species such as Red-legged Partridge, Thekla Lark and Stone Curlew. However, cultivation certainly plays an important part as the foraging area for Woodpigeons (*Columba palumbus*) who are divided in their preference between these crops and the *juncigraminetum* at the edge of the *marisma* and the lagoons. Some Quail (*Coturnix coturnix*) seem to nest here as well.

Buildings are few and of little importance. The largest are the

\*This is the Russian dandelion (*Taraxacum kok-saghyz*), from which a type of rubber is produced.

Palacio de Doñana and Las Marismillas. At the Palacio we have found the following fauna:

(1) Reptiles and mammals

Moorish Gecko ( <i>Tarantola mauretunica</i> )	Garden Dormouse ( <i>Eliomys quercinus</i> )
Mouse-eared Bat ( <i>Myotis myotis</i> )	Rat ( <i>Rattus</i> sp.)
Pipistrelle Bat ( <i>Pipistrellus</i> sp.)	House Mouse ( <i>Mus musculus</i> )
Serotine Bat ( <i>Eptesicus serotinus</i> )	(The Mouse-eared and Schreiber's
Schreiber's Bat ( <i>Miniopterus schreibersii</i> )	Bats have both been found when about to give birth.)

(2) Birds

Barn Owl ( <i>Tyto alba</i> )	Spotless Starling ( <i>Sturnus unicolor</i> )
Swallow ( <i>Hirundo rustica</i> )	House Sparrow ( <i>Passer domesticus</i> )

Some isolated buildings near the beach, including one of the medieval watch-towers (Torre Carbonero), an old ruined barracks, some ruined houses and a few inhabited houses, carry a fauna poor in species and individuals. We have seen there the following:

Reptiles and birds

Wall Lizard (*Lacerta bocagei*)—common in the tower  
 Peregrine (*Falco peregrinus*)—one pair breeding on the tower  
 Kestrel (*Falco tinnunculus*)—one pair nesting on the barracks  
 Barn Owl (*Tyto alba*)—one pair in the same tower as the Peregrines  
 Little Owl (*Athene noctua*)—nesting not proved in this habitat  
 Jackdaw (*Corvus monedula*)—several pairs in the ruined buildings, including one pair down an old well, 8 metres deep (26 feet)

The nesting-season of the Peregrines is so timed that the young are growing up during the period of bird-migration (April-May), so that a variety of passage species are available for food. We have recorded the remains of Turtle Dove, Hoopoe (*Upupa epops*), Roller (*Coracias garrulus*), Red-necked Nightjar and many smaller migrants.

In the list of Coto birds associated with man the Hoopoe should perhaps also be included. In 1956 a pair took up residence in an old beehive at La Algaida. In 1957 they nested in a thatched roof at the same locality.

La Algaida may be taken as an example of the fauna of the little houses of the gamekeepers. Apart from the Hoopoe we have found there:

Moorish Gecko (*Tarantola mauretunica*)  
 Pipistrelle Bat (*Pipistrellus* sp.)  
 Swallow (*Hirundo rustica*)  
 Spotless Starling (*Sturnus unicolor*)

In the few kitchen gardens with some trees which exist on the Coto, the bird population is that already noted for the *Rubus* (bramble) thickets, plus a few pairs of Goldfinches. A pair of Golden Orioles nest in the Palacio eucalyptus grove (which is shown in the distance on plate 6 upper). In the past the Imperial Eagle has once made an eyrie in eucalyptus (El Puntal). Black Kites also nest in these trees. In 1952 near Marismillas we saw a fair number of nests of Azure-winged Magpie in these trees.

*The riverside broad-leaved trees.*

In the extreme north-west of the Coto are two little streams, generally waterless, which support a dense vegetation of broad-leaved trees—ash (*Fraxinus*), willow (*Salix*), elm (*Ulmus*), poplar (*Populus*) and dense bramble thickets (*Rubus*). These are the places called Soto Grande and Soto Chico. The bird population of these places is very like that of the bramble thickets on the Coto. Only one species can be added with certainty—Cetti's Warbler (*Cettia cetti*). Other birds may nest there, but this has not yet been proved.

## ACKNOWLEDGEMENTS

My sincerest thanks are due to Mr. E. M. Nicholson for his collaboration in the preparation of this paper, and for translating it into English; to Mrs. Pedro Weickert and Mr. R. D. Meikle for much help over the determination of the plants; and to Mr. I. J. Ferguson-Lees for checking through the typescript and making many useful suggestions, also for selecting and preparing captions for the photographic illustrations from the large series kindly put at his disposal by Mr. Eric Hosking, to whom I am also most grateful. For making the work possible I am indebted to Aranzadi (Museo de San Telmo, San Sebastian), to all the members of the 1957 Coto Doñana Expedition, particularly Mr. Guy Mountfort, the leader, and especially to the owners of the Coto Doñana and of Las Marismillas—above all, Don Mauricio González Díez. All deserve much more than this simple expression of my gratitude.

## REFERENCES

(Although, as mentioned last month, the publication of the full list of sources will be delayed until the end of this series on the Camargue and the Coto Doñana, the following two references must be given here—EDS.)

MOUNTFORT, G. (in press): *Portrait of a Wilderness*. To be published by Hutchinson, London.

NICHOLSON, E. M., FERGUSON-LEES, I. J., and HOLLOW, P. A. D. (1957): "The Camargue and the Coto Doñana". *Brit. Birds*, 1: 497-519.

**BROKEN EGGS IN PEREGRINE EYRIES**

By D. A. RATCLIFFE

DURING the eight years from 1949 to 1956, among a considerable number of eyries of the Peregrine (*Falco peregrinus*) that I examined, there were fourteen in which one or more eggs were either broken or disappeared, with no evidence of human or other outside interference. This would seem a larger number than could be explained by chance accidents alone. Nor was this a local occurrence, as the records, which are listed below, refer to fourteen different inland haunts in widely separated regions. In no case was an eyrie deserted when first seen. All the observations are my own, except in the three cases where the name of another observer indicates that he was responsible for the later visit or visits.

- (1) *Scotland* 18th April 1949: c/2 and one egg broken below the nest.
- (2) *England* 10th April 1951: c/3.  
12th April: c/1 and broken remains of the other two eggs.
- (3) *Scotland* 18th April 1951: c/2 and broken remains of at least one more egg in nest.
- (4) *Wales* 29th April 1951: c/2.  
3rd May: c/1 and broken remains of the other egg in the nest.

- (6) *Scotland* 8th April 1952: c/3 and broken remains of at least one more egg in the nest.
- (5) *Scotland* 4th June 1951: c/2 and broken remains of at least one more egg in the nest (repeat laying of a pair seen with c/2 on 16th April 1951).
- (7) *Wales* 11th May 1952: c/1 and broken remains of other eggs in the nest.  
30th May: last egg broken but bird sitting on the eyrie.
- (8) *Scotland* 6th April 1953: c/3 and broken remains of another egg below the nest.
- (9) *Wales* 25th April 1953: c/2 and broken remains of at least one more egg in the nest.
- (10) *England* 8th April 1955: c/4.  
Reported later with c/2 and these disappeared one by one.
- (11) *Scotland* 17th April 1955: c/2.  
Reported later with c/1, but this proved infertile, and the nest was finally deserted (W. Murdoch).
- (12) *Scotland* 20th April 1955: c/2.  
25th May: c/1 and broken remains of the other egg in the nest (W. J. Eggeling); eyrie deserted but both Peregrines still about.
- (13) *Scotland* 12th April 1956: c/4.  
27th May: 1 young and 1 infertile egg (E. Blezard).
- (14) *Wales* 18th April 1956: c/1 and broken remains of other eggs in the eyrie.  
Nest later reported empty.

In (11) and (12), the single remaining eggs were finally deserted after being incubated beyond the normal period.

Besides these definite records of broken and disappearing eggs, there has been circumstantial evidence pointing to other similar occurrences. On 19th April 1955, three eyries with 1, 1 and 2 eggs respectively were found in the same region as nest (12) above. Although I reached only one eyrie, incubation was evidently advanced in all three, indicating that the birds had finished laying. Such abnormally small clutches could be most readily explained by the disappearance of eggs.

Thirteen of the definite cases of breakages or disappearance were during the period 1951-56 and represent over a fifth of a total of 59 eyries with eggs seen in that time; four out of nine eyries found in 1951 had broken eggs. By contrast, only one instance of breakage—record (1)—was noted in a total of 35 eyries with eggs examined during the preceding years 1945-50. Probably more breakages would have been found had I been able to re-visit all the discovered eyries later in the season; usually only a single visit was possible. At least two more such instances were reported from the North of England in 1955 and it would be surprising if no other cases have occurred.

These incidents do not seem to have been frequent enough to have attracted comment in earlier years, though in 1924 E. Blezard saw a Lakeland eyrie with 4 eggs and a fifth freshly broken on a ledge below. Ryves (1948) noted two cases of disappearing eggs (in 1932 and 1937) among the Peregrines of the Cornish Coast, though he does not mention broken eggs. It is well known that Peregrine broods often number only one or

two young out of a set of 3-4 eggs, but my own records indicate that single youngsters were particularly common during the years 1951-1956. Nestling mortality and the rather high proportion of infertile eggs would normally account for small broods, but more recently the breakage of eggs has probably been an additional cause in some cases.

In only one instance is there direct evidence as to the cause of breakage but I believe that it could explain the majority of these occurrences. On 12th April 1951 I re-visited an eyrie—no. (2) on the list—which had held 3 eggs on 10th April. My approach was undetected by the Peregrines and from a point about 15 yards distant and level with the eyrie, I saw the female standing on the edge of the scrape, pecking at its contents. It became obvious that the falcon was eating her own eggs and when she was flushed, the nest was found to contain only one intact egg, together with the freshly broken remains of the other two. One egg had been smashed long enough for the residual traces of yolk and albumen to have congealed.

At eyrie no. (8), the broken egg beneath the nest had been eaten and not accidentally kicked off the ledge. It was sucked dry, with a gaping hole in the shell—but not made in the manner of a Carrion Crow (*Corvus corone*) which also usually carries away its spoil. Two years previously, at this same haunt, the remains of a Peregrine egg were found on a slope some way from the nearest nesting ledge. The broken egg in eyrie no. (1) could have been eaten, for it was unlikely to have rolled into the deep crevice where it reposed several yards below the nest. This instance had other peculiar features, as the broken egg was pure white (with a shell of normal thickness) contrasting with the brick-red pair in the eyrie, and two hen Peregrines besides the tiercel were in evidence about the nesting crags. The eyries with broken eggs all had the same appearance as the one at which the bird was seen to eat its eggs—with numerous small fragments of shell lying in the scrape.

It seems unlikely that breakage of only part of a clutch could be due to direct human interference. On the other hand, there is the possibility that egg-eating might result from the Peregrines' reactions to human intrusion—but two lines of evidence weigh against this idea. First, in most cases when the damage or loss had occurred before my first visit, I had good reason to believe that no one else had previously been to the eyrie that season. Secondly, the data show that this phenomenon has become prevalent only during the last few years, indicating that the real cause has only recently become operative.

It is highly improbable that Ravens (*Corvus corax*) or Carrion/Hooded Crows would steal eggs from any but a deserted Peregrine eyrie. Accidental breakages may sometimes occur, but hardly in such a high proportion of eyries, and though infertile eggs are frequent, they are usually left in the nest and may remain even after the young have flown. Small clutches could be explained

by the taking of one or two eggs, though those bent on acquiring Peregrines' eggs can seldom resist the whole clutch. Peregrines do not usually continue to lay if an incomplete set of eggs is taken, nor do they "make up" a clutch to the full strength if odd eggs are removed.

Having considered the evidence and the alternative explanations, it is difficult to avoid the conclusion that the majority of these broken eggs were eaten by one or other of the owners. Should this be the correct explanation, the reason for this peculiar behaviour is even more obscure. If a shortage of food were possible, such actions would certainly have significance in reducing the brood size. However, a catholic choice of prey in an efficient hunter such as the Peregrine would make a general food scarcity seem an unlikely event. On the other hand, Dr. J. D. Lockie suggests to me that any bird with asynchronous hatching—and the evidence indicates that the Peregrine is one of these—must at times go short of food, and that in this phenomenon the species already has a device for adjusting brood size to food supply (*cf.* Lockie, 1955).

Vesey (1938) recorded two cases of smashed and disappearing eggs and two small clutches (1 and 2 eggs) in a series of eight Iceland Falcon (*Falco rusticolus islandicus*) eyries. Goodwin (1956) has put forward strong evidence to show that parental egg-eating is common in Jays (*Garrulus glandarius*) and suggests that the practice may be more prevalent among birds than is suspected. From the work of Brown and Davies (1949), he quotes the Reed Warbler (*Acrocephalus scirpaceus*) as another possible example. E. Blezard tells me that he has often found Dunnock (*Prunella modularis*) nests with clutches of broken eggs, which appeared more likely to be the work of the birds themselves rather than predators. Finally, I am informed that among certain native birds in captivity, such as the Goldfinch (*Carduelis carduelis*), egg-eating is a common incident, but usually by the male when caged with his mate. However, the artificial conditions under which these birds live might occasion such abnormal behaviour in this case.

Perhaps this note will draw records of similar experiences from other observers. In any event, it would be interesting to know how widespread and numerous these peculiar incidents have been during recent years.

#### REFERENCES

- BROWN, P. E. and DAVIES, M. G. (1949): *Reed-Warblers—An Introduction to their Breeding Biology and Behaviour*. East Molesey.
- GOODWIN, D. (1956): "Further observations on the behaviour of the Jay *Garrulus glandarius*". *Ibis*, 98: 186-219.
- LEWIS, E. (E. Vesey) (1938): *In Search of the Gyr-Falcon*. London.
- LOCKIE, J. D. (1955): "The breeding and feeding of Jackdaws and Rooks, with notes on Carrion Crows and other Corvidae". *Ibis*, 97: 341-369.
- RYVES, B. H. (1948): *Bird Life in Cornwall*. London.



# UNCOMMON MIGRANTS AT PORTLAND BILL DURING THE AUTUMN OF 1956

By K. D. SMITH and J. S. ASH

THE FOLLOWING NOTES on birds seen in the immediate vicinity (approximately one square mile) of Portland Bill, Dorset, during the autumn of 1956, have been taken from the daily journals maintained at Portland Bird Observatory. Full details of the birds seen have been submitted to the Editors of *British Birds*. For the sake of brevity only those observers who actually contributed field or laboratory notes are mentioned here (see below); others will be named in the regional reports. All the birds included in the Systematic List, with the exception of some shearwaters, skuas, the Coal Tit and the Blue-headed Wagtail, were seen by one or the other, or both, of the writers.

Local wind directions and strength were as follows: 11th-21st August, S.W., often gales, up to force 9; 22nd-23rd August, E. to S.E., mild breeze; 24th-30th August, S.W. to N.W., often strong; 31st August-25th September, variable but mainly E. to N.E.; 26th September-8th October, S.W. to N.W., frequently strong or gales; 9th-15th October, variable, mainly E. to N.E.; 16th-29th October, S.W. to N.W.; 30th October onwards, very variable. No attempt is made here to analyse the meteorological conditions which may have accounted for the occurrence of some of the migrants.

The arrival of most, although not all, of the more uncommon Passerines can be correlated with periods when winds were mainly from an easterly direction; notable exceptions are the Olivaceous Warbler and Red-breasted Flycatcher. Lapland Buntings appeared to arrive at Portland with easterly or westerly winds, and it seems feasible that they came from widely separated breeding areas. South Dorset came well within the area of the British Isles affected by the "rush" of drift migrants during the first two weeks of September. It is worth mentioning that, in addition to the more uncommon visitors, a Quail (*Coturnix coturnix*), 7 Corncrakes (*Crex crex*), ca. 250 Turtle Doves (*Streptopelia turtur*), ca. 100 Whinchats (*Saxicola rubetra*), ca. 40 Pied Flycatchers (*Muscicapa hypoleuca*) and 10+ Grasshopper Warblers (*Locustella naevia*) were recorded in the great "drift" from the south-east on 9th September. At least 4, possibly more, Wrynecks (*Jynx torquilla*) were seen, two being trapped, between 9th and 23rd September.

## SYSTEMATIC LIST

BALEARIC SHEARWATER (*Procellaria puffinus mauretanicus*).—Recorded on four days in August, the first of the autumn on the 16th, maximum 3 on the 26th. Noted on six days in September, mainly during the last week, maximum 9 on the 10th. Noted on fifteen days in October, but not after the 24th, maximum 11 on the 24th. 78 birds observed in all; of these where flight direction was recorded 31 flew east and 7 west. In early October several were seen within fifty yards of the shore feeding with other sea-birds on inshore shoals of sprats or pilchards. An injured bird watched at very close

quarters had yellowish-brown legs; the upper-parts were variously described as "medium-brown", "colour of Swift", "greyish-black", "dusty or sooty brown"; it frequently dived from the surface of the sea, and used its wings underwater.

In contrast, only a few Manx Shearwaters (*Procellaria p. puffinus*) were recorded during the same period, with only 2 in October, both on 2nd. (Birds have been seen at quite close quarters which do not correspond with either of the above races. It is suspected that the race *yelkouan* may be present in the Channel. The prospects of obtaining a specimen are remote.)

SOOTY SHEARWATER (*Procellaria grisea*).—One flying east on 24th October.

DOTTEREL (*Charadrius morinellus*).—Singly on 11th and 13th September. Flight note a quiet, hard "pew" or "chew", difficult to express in words. The same, or another bird, was seen daily on short-grass saltings at Ferrybridge,  $4\frac{1}{2}$  miles north of Portland Bill, from 12th to 17th September.

GREAT SKUA (*Stercorarius skua*).—2 on 17th and 26th August, single birds on 13th September, 8th and 11th October.

LITTLE GULL (*Larus minutus*).—1 flying west on 24th August, 1 coasting east on 6th October.

GREAT TIT (*Parus major*).—1 trapped on 15th October which, from the slender and shallow bill, appeared to be of the Continental race (*P. m. major*).

COAL TIT (*Parus ater*).—1 seen on 14th October which, from the slate-grey upper-parts, agreed with the Continental race (*P. a. ater*). The species is quite absent as a breeding bird from the "island" of Portland.

BLUETHROAT (*Cyanosylvia svecica*).—A ♀ trapped on 2nd September, wing 70 mm. 3 ♂♂ on 9th September, two of which were trapped and measured: weight 24.7 gms., wing 80 mm.; and weight 21.0 gms., wing 76 mm. Racial determination could not be made with certainty.

MARSH WARBLER (*Acrocephalus palustris*).—Singly on 4th, 8th (retrapped on 11th) and 14th September. All trapped and none watched in the field. Leg colour variable: in one the legs were described as palish brown with no fleshy tint; in another, pale brown with a tinge of lead-blue; and in the last, pale brown with a less obvious lead-blue tinge. In contrast only one Reed Warbler (*Acrocephalus scirpaceus*) was recorded (trapped) during the autumn, on 22nd August.

AQUATIC WARBLER (*Acrocephalus paludicola*).—1 caught in a trap sited in a ditch overgrown with willow-herb and rushes, 2nd September. Weight 13.2 gms., wing 61 mm.

OLIVACEOUS WARBLER (*Hippolais pallida*).—1 self-trapped on 16th August (full details of this record will be appearing in *British Birds* in a separate note).

BARRED WARBLER (*Sylvia nisoria*).—Single birds on 9th/10th September, 12th and 21st October. Two caught and found to be first-winter birds. Inhabiting bramble, blackthorn thickets and *Euonymus* bushes. The first bird weighed 30.1 gms., and wing 89 mm.; the second 23.2 gms., and 85 mm.

CHIFFCHAFF (*Phylloscopus collybita*).—1 on 2nd September and another on 7th/8th November appeared to be of the Siberian form (*Ph. c. tristis*); neither was caught. In brief, they had olive-brown upper-parts, buffish-white superciliary stripes, dirty white under-parts; no trace of yellow in the plumage except on the primaries; the legs looked black; unfortunately both were silent when under observation. Also, 1 on 2nd, 1 on 8th and 3 on 9th September were thought to be very pale birds by various observers, but no detailed descriptions were made at the time.

FIRECREST (*Regulus ignicapillus*).—A ♂ on 23rd September, a ♂ (trapped) on 11th/12th October, a ♂ and ♀ on 11th November.

RED-BREASTED FLYCATCHER (*Muscicapa parva*).—A ♀ or young ♂ on 1st/2nd October. It fed at times on the ground, more regularly than the *Handbook* suggests.

TAWNY PIPIT (*Anthus campestris*).—3 on 9th September, one being trapped; weight 25.5 gms., wing 89 mm. 1 remained throughout 10th/11th September. One of those on the 9th frequently uttered a rather hard, somewhat Linnet-like twittering (D.D.H.); that on the 10th used the more typical "chir-up" or "chew-up".

A large pipit seen flying south high over the fields on 23rd September was, from the call, a disyllabic "chew-up", considered to be this species by K.D.S. who was very familiar with the bird in Eritrea.

BLUE-HEADED WAGTAIL (*Motacilla f. flava*).—A ♂ with a flock of *flavissima* on 11th September.

WOODCHAT SHRIKE (*Lanius senator*).—A juvenile trapped on 22nd August. Weight 33.9 gms., wing 98.5 mm.

BULLFINCH (*Pyrrhula pyrrhula*).—A ♀ on 10th September and a ♂ on 8th October.

ORTOLAN BUNTING (*Emberiza hortulana*).—5 or more on 9th September, 2 on the 10th, 1 on the 15th; another small influx on 22nd/23rd September when 3 were seen, 1 on the 24th. Frequently seen perching in an isolated sycamore tree in a garden, or feeding in stubbles. Described as rather dull greyish-green birds with dark brown upper-parts streaked blackish-brown, yellow orbital rings and dull yellow-green moustachial stripes, yellow-brown rumps, white outer tail-feathers and pink bills. Call a liquid "quip quip".

LAPLAND BUNTING (*Calcarius lapponicus*).—Recorded for the first time at the observatory in most unusual numbers for southern England from 22nd September onwards. The first influx, a flock of 5+, occurred on this date, and there were 8 on 23rd and 1 on 24th. 2+ appeared on 6th October, 2 on the 14th and 6+ on the 16th; at least one on the 24th, 2 on the 26th. The latter (presumably) were seen on many days until 18th November when 4 were present. After that there were 3 until 24th November when 5, possibly 9, were seen. At least 4 until 22nd December,

The early arrivals were extremely wild and difficult to approach, but November birds were less so. They could be identified by their characteristic call-note, which was more frequently rendered "teu—tr-r-r-t" rather than the opposite (the "ticky-tick-teu" of the *Handbook*). The "teu" and the "tr-r-r-t" were also used separately, the sharp and abrupt "teu" carrying far. Other flight notes heard were a "chup", very like one of the flight notes of a Chaffinch (*Fringilla coelebs*), a rather hard "tu-tu-tu" and a plaintive "tee-oo". Early arrivals fed mainly in stubbles, and later in ploughland and occasionally on turf near the cliff-edge. They crouched low in the stubbles, preferring to run fast rather than to fly. They were pugnacious to Meadow Pipits (*Anthus pratensis*) and a Swallow (*Hirundo rustica*) which came too close. More often than not they associated with flocks of Skylarks (*Alauda arvensis*), but those on 18th November were accompanied by a Snow Bunting (*Plectrophenax nivalis*). A first-winter ♂ was trapped on 24th October; weight 29.0 gms., wing 92 mm. At 0722 hours on 26th October 2 birds, and 1 at 0750 on 27th October, were seen arriving from the Channel. They came in low over the sea from the south, calling "teu—tr-r-r-t" several times as they flew past the observer (K.D.S.).

#### LIST OF OBSERVERS

H. G. Alexander, D. G. Barnes, Jacques Blondel, Bryanston School N.H.S., A. J. Bull, H. J. Clase, G. B. D. Chidwick, F. R. Clifton, Miss M. D. Crosby, E. G. Darton, K. V. Edwards, D. D. Harber, R. J. Jackson, E. L. Jones, Bernard King, G. Kinsey, A. R. Mead-Briggs, G. W. H. Moule, C. Perrins, Dr. K. B. Rooke, A. B. Sheldon, J. Shepperd, J. J. Swift, W. H. Tucker, G. E. C. Waterhouse, J. A. Wigzell and Miss D. Yorke.

## NOTES ON THE WREN IN THE ARAN ISLANDS, IRELAND

By EDWARD A. ARMSTRONG

WHAT MAY be described as the integrative pattern of the breeding behaviour of the Wren (*Troglodytes troglodytes*) varies in different types of environment (Armstrong, 1950-57). Differences in behaviour patterns are so integrated in this species, and no doubt

in others, that variation in one tends to be associated with correlated variations in others. In theory, if a given population of an organism evolved a sufficiently distinctive group of behavioural adaptations, related to the environment and all correlated with one another in a biologically advantageous way, a barrier would be established to the inter-breeding of this population with other related populations, and divergence towards the formation of a separate species would occur. The Wren is an outstanding example of a species able to vary a group of such adaptations according to the environment. Its adaptability lies, not merely in the extent to which a number of behaviour-patterns may be modified to suit circumstances, but in the nicety with which these adaptations are related to, and integrated with, each other.

Wren adaptations vary according to the degree to which the habitat may be classified, for our purpose, as "bleak" or "fertile". The distinction is essentially ecological rather than geographical, but in geographical terms the extreme types may be roughly divided into "northern insular" and "mainland" or "continental". The St. Kilda Wren (*T. t. hirtensis*) represents one extreme, the Wren in average garden-woodland areas in England and on the Continent the other. The adaptations of the latter include a strong tendency to be polygamous, the building of a considerable number of auxiliary nests, a prolonged period of song reaching two maxima of output in April and June, and second broods as a normal procedure. This type is characteristic of habitats containing a readily available food-supply. The tendencies of the Wrens of bleak habitats are towards monogamy, less nest-building, a shorter period of vigorous song, fewer second broods and greater activity by the male in tending the brood in and out of the nest.

The fundamental environmental factor determining the type of behaviour is, in my view, the availability of food. Where food for the young is relatively scarce and brood-size remains the same as where it is abundant, the male's aid in feeding the young is indispensable. In bleak habitats the broods of polygamous males would be in jeopardy from malnutrition, as, even if the male were to devote himself to helping his females, he would have to distribute his efforts over two or more broods. Selection has operated in such areas in favour of monogamy. Thus a species may adapt itself to different habitats by modifying behaviour rather than altering brood-size.

Comparison of the behaviour of bleak area and fertile area Wrens shows that in bleak areas the male is more attentive to the young than in fertile areas, but observation indicates that in fertile areas, where the female relaxes her efforts, the male may act to supplement them. If the female disappears when the chicks are a few days old, he may devote his energies almost wholly to tending them and behave to all intents and purposes like a female. The stimulus which triggers such behaviour is evidently the

begging behaviour of the young. This behaviour-mechanism, operating in bleak areas, would tend to attach the male more definitely to domestic duties and thereby reduce polygamous tendencies, but as it would not have any effect until the eggs had hatched it would not be sufficient to account for the difference between bleak area and fertile area behaviour. We may assume that latent in both types of Wren is the capacity to behave in some measure according to the pattern of the other extreme. But, theoretically, adaptation to one or the other type might advance beyond the possibility of reverting to the other behaviour-type even on return to an environment which strongly favoured it. The elucidation of the genetic bases of such a group of correlated adaptations would be of great interest.

The Aran Islands, Inishmore, Inishmaan and Inisheer, at the entrance to Galway Bay in Ireland, provide Wren habitats which are intermediate between the two extremes, though of "fertile" rather than "bleak" type, and therefore an enquiry into the behaviour of the birds there was made to try to discover to which pattern their activities most closely conformed. My stay on Inishmore was from 18th to 22nd May 1957. In spite of its brevity and the inadequacy of the investigation, some clues useful for the solution of the problem were obtained.

Only six miles separates the smallest of the three islands, Inisheer, from the Clare coast. In default of meteorological records, accurate comparison between the climates of the Aran Islands, St. Kilda and Shetland is impossible and the difficulties of comparison are further accentuated owing to the differences in geological formation and vegetation. Aran is of carboniferous limestone clothed with calcicole plants whereas the Shetland Isles are mainly composed of schist. The general impression is of a milder climate and richer flora and fauna than is found on St. Kilda or islands of comparable size in Shetland. Arum lilies grow out of doors in Aran and dracaenas (*Cordyline australis*) reach a height of twenty feet. Frost is rare. There is little cultivated land, but on Inishmore a good deal of pasture land intersected by innumerable dry stone walls—as along the Connemara coast. The "undeveloped" areas are mainly limestone pavement with a rich and interesting flora growing in the interstices sheltered from the wind.

#### HABITAT

Although Inishmore is bare and windswept there are a few small groves of trees and, near the houses, much scrubby vegetation. There are, of course, no woods or heather moors such as shelter some Wrens in the Hebrides and Shetland. Brambles, ivy and thick herbage grow along the walls and on rocky declivities. High winds are mainly responsible for preventing the growth of more luxurious vegetation. The Wrens are found mainly near the

cottages, where rocky banks occur and in the bramble tangles bordering the walls. Territories sometimes extend some way into the stony areas, but not to any extent into the limestone pavement nor at all on the short flower-spangled turf sloping up to the cliffs. It is not surprising that there are no Wrens on the cliffs themselves for they are without vegetation and exposed to the impact of waves which are sometimes strong enough to destroy the stonework of ancient dwellings on the tops of cliffs 100 feet high. In contrast, Wrens on St. Kilda and the Shetland Isles establish territories on the vegetated cliffs.

Thus, on Aran, as contrasted with St. Kilda and Shetland, wren habitats are mainly due to the influence of man, for human labour has created not only the dwellings and walls but also the pasture land, built up from the sand and seaweed carried up from the shore by generations of islanders. Robin (*Erithacus rubecula*) habitats always hold Wrens, but Wren territories extend into rougher, more open ground. This is in keeping with the greater adaptability of the Wren. The greater the distance of islands from the British mainland the poorer the avifauna (Lack, 1942; Darling, 1947) and the Robin drops out of island bird lists much sooner than the Wren. Judging by the appearance of the vegetation and the greater concentration of insectivorous Passerines as compared with St. Kilda or Shetland, food suitable for Wrens would be more readily available than in these island groups. Wrens are more abundant than on the Burren, the corresponding limestone formation on the mainland, and this seems to be related to the meagreness of human population and activity there.

#### TERRITORY

A road runs longitudinally across Inishmore. The main human and Wren population is concentrated along it. Wren territories were located at distances apart of 200-300 yards—somewhat closer, it seemed, than Wren territories on low cliffs in Shetland. Territorial aggressiveness was apparent. Song by a male elicited song from neighbours, and in at least two instances the menace of encroachment by a singing rival caused the territory owner to advance and sing against him with great vehemence. Such behaviour at the stage of the breeding cycle which these birds had reached is more typical of fertile, mainland regions than of bleak, insular areas. This is because polygamous males, neglectful of nestlings and ardent to secure mates, have a greater song output than males preoccupied with feeding young. I was unable to estimate the area of territories, but I formed the impression that they were comparable with those in southern England.

#### SONG

Now that objective methods of analysing bird song are available, subjective estimates have limited value, but it seemed to me that the song differed in some respects from that of the Wrens I had

been hearing near Cambridge. (I also thought that Wrens at Clew Bay and Galway sang differently from Cambridge birds.) Aran songs were remarkably variable. I listened to one bird at 05.00 G.M.T. for 15 minutes before I could be certain it was a Wren. Its song had no trace of a trill. Another bird repeated a long, elaborate song in which the first of three trills seemed to alter its pitch half-way. One bird sang five songs to the minute, another ten. Making allowance for the extent to which any Wren can alter its song according to circumstances, and also for variability being accentuated towards the end of a breeding cycle, there appeared to be more variability between individuals than I had noted elsewhere. There was a considerable amount of song, not only early in the morning but at all hours of the day.

A male, assiduously feeding nestlings, and no doubt stimulated by the presence of his mate, also feeding the chicks, sang very brief, soft songs consisting of a trill on a single note, with a slurred end note. Sometimes he made slight fluttering movements with his wings—reminiscent of the more active courtship wing-quivering of Wrens earlier in the season. Such behaviour is most typical of northern insular Wrens, for the males are more frequently close to their mates at the nest.

#### NESTING

Finding nests on Aran was more difficult than in the Hebrides, Shetland or St. Kilda. On these northern islands a bird feeding young can be readily followed up and the nest discovered, usually without much trouble. On Inishmore the birds disappeared into the dense briar thickets bordering the dry-stone walls and I was unable, in the time at my disposal, to locate the nests. I was near enough to one nest to hear the chicks calling. Some nests are probably situated quite out of sight in crevices of the overgrown stonework. No doubt other nests are placed in more conspicuous and vulnerable niches, for the Wrens of all habitats do not keep to any stereotyped type of site. Irish boys have never indulged in birdnesting to the extent that boys in England have, and the only time the Wren is persecuted is in the midwinter ritual of the Wren Hunt (*Armstrong*, 1957b, and in press). Such effective concealment of the nest appears to be due to the ample number of well-hidden cavities rather than the selective pressure of local predators.

#### NESTING-SEASON

A group of newly-fledged young was noted on 19th May, a female carrying prey the next day, and a pair feeding nestlings on 22nd May. As the period of the nesting cycle of Wrens from the end of egg-laying to fledging takes approximately just over a month, egg-laying on Aran evidently occurs about mid-April or a little later. Allowing for seasonal variations, breeding seems to begin no later than in southern England and Holland. In contrast the nestlings of Wrens in the Hebrides, Shetland and St. Kilda are commonly still unfledged during the first week or two of

June and the chances of the parents raising second broods are correspondingly reduced. This is a crucial consideration, so far as the relationship of the Aran birds' behaviour to one or other of the types is concerned, for the inference is that in the matter of second broods the Aran Wrens approximate to the breeding pattern of fertile area birds.

#### DISPLAY AND PAIR-BOND

During periods of observation on two days a male was constantly "ticking" and replying vigorously with song to a neighbouring male who was trying to encroach. Sometimes he sang on the wing—an indication of an excitable sexual condition. He flew towards his rival and compelled him to retreat. This bird was preoccupied with a female who behaved as if she had no family responsibilities. From time to time he pursued her in sexual chase and once or twice performed the fluttery courtship flight with rapidly beating wings and comparatively slow progress. These activities suggest that in mid-season a male is ready to start a second brood and pair-up with a roving female. Such behaviour would be consistent with polygamy.

A female was seen carrying food for young which, judging by her behaviour, were in a nest close by. About 150 yards along the road I noted a female feeding a fledged brood with the male singing near at hand. No other male was noted in this area. This suggests, though it does not prove, bigamy.

#### DISCUSSION

Meagre as these data are, and much in need of supplementation by observers able to spend long periods observing the Wrens of other islands, they indicate, in my opinion, that the breeding behaviour of Aran Wrens is more like that of the mainland, fertile area type than that of the bleak, northern island type. This confirms that the distinction is ecological rather than geographical. The relatively early inception of breeding, the vigorous defence of territory and sexual ardour at mid-season, the indications that second broods occur and the suggestions of polygamy are all consistent with the fertile area pattern of behaviour. On the other hand, the behaviour of the male ardently feeding chicks and performing wing-flutters near the nest is rare among fertile area Wrens, but, so far as my observations and those of others go, is frequent among northern insular Wrens. I conclude that while the behaviour of Aran Wrens conforms mainly to the fertile area type there are indications that, in response to the more rigorous conditions, there is a tendency towards the bleak area type. A study of Wrens in mountainous marginal habitats would be of interest. One would expect them to conform to the latter type.

#### SUMMARY

The breeding behaviour of Wrens on the Aran Islands, Ireland, conforms more to the fertile area type than the bleak insular area



type. Bleakness, with relative inavailability of food, is the factor governing the modification of the integrated behaviour patterns.

#### ACKNOWLEDGEMENTS

I am grateful to Mr. Seán Sweeney, Mr. Ciarán Barrett, and to Professor Seán Delargy and other members of the Irish Folklore Commission, for making arrangements for my visit to the Aran Islands and coastal areas of the west of Ireland.

#### REFERENCES

- ARMSTRONG, E. A. (1950): "The behaviour and breeding biology of the Iceland Wren". *Ibis*, 92: 384-401.  
 — (1952): "The behaviour and breeding biology of the Shetland Wren". *Ibis*, 94: 220-242.  
 ;— (1953a): "The behaviour and breeding biology of the Hebridean Wren". *Brit. Birds*, xlv: 37-50.  
 — (1953b): "The history, behavior and breeding biology of the St. Kilda Wren". *Auk*, 70: 127-150.  
 — (1953c): "Island Wrens". *Brit. Birds*, xlv: 418-420.  
 — (1955): *The Wren*. London.  
 — (1956): "Territory in the Wren". *Ibis*, 98: 430-437.  
 — (1957a): "Birds of the Aran Islands". *Irish Nat. Journ.*, xii, 207-208.  
 — (1957b): "The wren-boys' ritual". *Country Life*, 122: 1417-1418.  
 — (in press): *The Folklore of Birds*. London.  
 DARLING, F. F. (1947): *Natural History of the Highlands and Islands*. London.  
 LACK, D. (1942): "Ecological features of the bird faunas of British small islands". *J. Anim. Ecol.*, 10: 9-36.

#### NOTES

**American Snipe in Lancashire.**—On 30th September 1957, Mr. Stephen Brady brought into the Bolton Museum a Snipe (*Capella gallinago*) which he had picked up dead near Rumworth Reservoir, Bolton, Lancashire. The bird was very stale, but I managed to preserve it since at first glance it was extremely dark. Subsequent examination showed that in every characteristic it resembles the North American race *delicata* (which is generally known as Wilson's Snipe in the United States). Through the kindness of Colonel R. Meinertzhagen I was able to compare it with a wide range of skin material and with a series of preparations of axillaries and outer tail-feathers from British and American birds.

Apart from the darker tone throughout, the Rumworth bird is quite strongly barred on the upper breast and has the flanks closely and heavily barred, while the axillaries have more black than the normal European type. The most critical factor, however, is the width of the outer tail-feather which is only 5 mm. measured at 20 mm. from the tip. Several of the tail-feathers are unfortunately missing and it is not therefore possible to be certain as to their original number.

Although the Snipe is a variable bird, it is extremely unlikely that a chance variant would embrace all the characters of the

North American form and added credence may be given to the record by the number of other Nearctic waders which occurred about the same time.

Although there is only one other acceptable record for the British Isles, it is hardly likely that the race could ever satisfactorily be determined in the field or that many of the large number shot annually are critically examined, although the width of the outer tail-feathers is a ready and reliable guide.

It may be pertinent to remark that I can find no observation as to the comparative sounds made by either race in drumming, although the difference in the width of the outer tail-feathers can hardly fail to produce vibrations of different timbre.

ALFRED HAZELWOOD

**Collared Flycatcher on Bardsey.**—In late afternoon on 10th May 1957 a routine visit was made to Nant withy bed, Bardsey Island, Caernarvonshire, by workers at Bardsey Bird and Field Observatory. Their attention was drawn by a strikingly white and black bird, which was identified as a male Collared Flycatcher (*Musicapa albicollis*). The only familiar British bird with which it was reasonable to compare it was a male Pied Flycatcher (*M. hypoleuca*), although none was present. It was of similar size, although in certain lights the white areas made it appear larger. A broad white collar, long broad white wing-bar and whitish rump were clearly seen at various ranges, with and without binoculars, often at distances of only a few feet. These were good characters, even at long distances, and the whiteness in general was remarkable, as was the pureness of the black.

During the two-hour period for which the bird was under observation it frequented the withy bed, stone walls and gardens near-by. When flying from one area to another, it normally flew at a few feet above the ground, although apparently quite strongly. An unsuccessful attempt was made to take it in a nylon net.

The bird was seen by R. W. Arthur, K. Billings, E. R. Corté, G. A. Dangerfield, B. Griffiths, G. F. Griffiths and T. Griffiths. This is the first record for Wales.

During the early hours of 10th May there had been a strong fall of Sedge Warblers (*Acrocephalus schoenobaenus*), White-throats (*Sylvia communis*) and Willow Warblers (*Phylloscopus trochilus*). A Sedge Warbler taken in the morning had been ringed at Jersey Bird Observatory on 16th May 1956.

REGINALD W. ARTHUR

**Alpine Swift in Norfolk.**—At 10.00 hours G.M.T. on 13th July 1957, at Cromer, Norfolk, I was watching a large number of Swifts (*Apus abus*) hawking along the cliffs, when I noticed among them a bird which I had no hesitation in identifying as an Alpine Swift (*A. melba*). This bird was larger and paler than the other Swifts, its head, back and wings being light brown in

colour. The under-parts were pure white except for a brown band across the chest, as in a Sand Martin (*Riparia riparia*). The under tail-coverts were very dark brown, almost black. The very large size of the bird was, perhaps, its most noticeable feature, but its flight was more powerful and interspersed with more frequent periods of gliding.

The bird was also watched by A. C. Church who saw it again on 15th July, but a search by numerous observers on 16th July failed to reveal it. It is interesting to note that there was a very large influx of Swifts at Cromer on 13th July. These birds gradually disappeared during the 16th and 17th. R. A. F. Cox

**Red-flanked Bluetail in Kent.**—On 28th October 1956, at Sandwich Bay Kent, G. Dunkling, U. Benecke and D. M. Batchelor found a dead bird which they brought to me. It had been freshly killed, and a Weasel (*Mustela nivalis*) which left the scene as they appeared was thought to be responsible. The bird was a Red-flanked Bluetail (*Tarsiger cyanurus*) and we provisionally identified it as a first-winter male—a conclusion that was subsequently confirmed by the British Museum (Natural History), where the skin is now deposited. This is only the second or third British record of this Asiatic and E. European species, one having been shot in Shetland in 1947 (*Scot. Nat.*, vol. 60, pp. 6-7), some 44 years after one was thought to have been seen in Lincolnshire in September 1903 (*antea*, vol. xlvii, pp. 28-30).

At the time we measured the bird and took a full description, as well as making coloured drawings. A copy of the full details has been supplied to the Editors of *British Birds*. As the skin can be examined in London, it seems sufficient to give only a short description here. The crown, nape, mantle and sides of neck were olivaceous-brown and the back was grey (indistinct as a result of the mauling the bird had received), shading to "Blue Tit blue" on the rump; the outer webs of the tail feathers were also blue, the outer pair obscurely so, the central feathers darker than the rest; wing-feathers were predominantly grey-brown, with pale chestnut outer webs and with black shafts that in the case of the secondaries exceeded the tips of the feathers; the chin was reddish-buff and the breast and belly white, the latter tinged lemon-yellow; the sides of the breast were brownish-buff where they joined bright orange flanks. The tail was markedly forked, the "centre" being 4 mm. shorter than the longest feathers.

DENNIS F. HARLE

## REVIEWS

TALES OF A WILDFOWLER. By ARTHUR CADMAN. Illustrated by PETER SCOTT. (*Collins*, London, 1957). 192 pages; many black-and-white drawings. 21s.

THIS IS a delightful book; its author is both an expert wildfowler and a keen ornithologist, and his writings prove that it is possible to combine these two interests, as indeed they should be combined by every wildfowler.

The book deals mainly with geese and goose shooting in various parts of the British Isles and there are many vivid descriptions of the wildfowler's world and some amusing and well told stories to enliven the text, which is full of accurate and careful observations. In this respect, the account of the feeding habits of the Greenland White-fronted Goose is of particular interest, as are the author's encounters with Red-breasted and Lesser White-fronted Geese in Wales, and with a Scottish Grey Lag Goose with symmetrical albinism in its primaries. My one disappointment about this book was that the author has not considered duck to the same extent as geese and they find very little mention.

The author is obviously a dog-lover and his two chapters on dogs are among the best. Like many wildfowlers of today he also keeps some wildfowl in his garden, many of which have been inadvertently pinioned by a shot. There are some useful hints on how such birds should be treated, to make them settle down successfully. His collection is obviously a source of great pleasure to him.

The book is enriched by scraperboard and line illustrations by Peter Scott—a great asset for any book, but more than this, I like to think that it is a happy omen for the future co-operation between the wildfowler and the ornithologist. This is a book which should be read by both, for it will do much to make the one appreciate the other's point of view.

J.G.H.

### COLOUR SLIDES

BIRDS ON THE WING and BIRDS AND NESTS. Colour slides from photographs by ERIC HOSKING. (*Diana Wyllie, Ltd.*, London, 1957). 20s. per set of six, from Diana Wyllie, Ltd., 18, Pont Street, S.W.1.

THE NEED for visual aids in lecturing and education has encouraged Diana Wyllie, Ltd., to produce a series of colour slides of natural history subjects, of which the above are the first examples. The two sets each consist of six 2in. by 2in. transparencies. The species illustrated in "Birds on the Wing (Slide nos. DW-A1 to DW-A6) are Song Thrush, Greenfinch, Lesser Spotted Woodpecker, Kingfisher, Wheatear, Swallow; and in "Birds and Nests" (Slide nos. DW-A7 to DW-A10) are Song Thrush (two), Black-headed Gull, Long-tailed Tit, Robin, Chaffinch. Each is accompanied by a booklet of short notes. The colour reproduction of Mr. Hosking's photographs is good, and at 3s. 4d. a slide the cost must be considered reasonable.

G.K.Y.

# REQUESTS FOR INFORMATION

## FIELD INVESTIGATIONS OF THE B.T.O.

The Scientific Advisory Committee of the British Trust for Ornithology recently decided that publicity should be given in *Bird Study*, the quarterly journal of the B.T.O., to analyses which will be the subject of future papers in *British Birds*. We are pleased to give reciprocal facilities to the B.T.O. New Trust investigations will always be announced first in *Bird Study*, but subsequently it may be useful to make additional announcements about them at shorter intervals than three months and, since a very large number of B.T.O. members are subscribers to *British Birds*, it should be possible in this way to reach most of those who are contributing to the Trust's field studies.

Announcements will not normally be made about the permanent enquiries run by the B.T.O.—the Bird-Ringing Scheme, the Nest Record Scheme and the Sample Census of Heronies.

Of the "Trust-aided Investigations", which run for shorter periods, the enquiry into **Autumn and winter flocks of Coots** organized by S. McClelland, 62, Torland Road, Hartley, Plymouth, is now in its last season, and Mr. McClelland hopes that more information will be forthcoming on the behaviour of the birds, as well as on actual counts. If we have a prolonged spell of hard weather in early 1958, it will be very interesting to compare behaviour and movements with the mild winter of 1956-57.

The B.T.O. also announces "Requests for Information" from time to time. These requests are not full investigations and contributors need not be members of the Trust; on the other hand, the Scientific Advisory Committee takes no responsibility for the subsequent publication of a report. Those recently announced are:

**Status of the rarer grebes** (F. D. Hamilton, 4, Bruntsfield Terrace, Edinburgh, 10). Observations required for British east and south coasts up to 30th April, 1958.

**Treecreepers' roosting sites** (J. M. D. Mackenzie, Greyfriars, St. Andrews, Fife). A study of the distribution of roosting sites in Wellingtonias. Information from all parts of the British Isles, if possible with dates when the habit was first noticed is required.

**Birds with deformed bills** (D. E. Pomeroy, Sidney Sussex College, Cambridge). Field observations on the behaviour of birds handicapped in this way are most valuable.

**Albinism and melanism** (B. L. Sage, 11, Deepdene, Potters Bar, Middlesex). Records for all species (except Mallard) and of any date, including past published references, are required.

**Marked Sand Martins**. Any information on the origins of birds seen last summer with white feathers apparently impeded to their plumage would be welcomed by R. A. O. Hickling, 223, Swithland Lane, Rothley, Leicestershire.

## RECENT REPORTS AND NEWS

By I. J. FERGUSON-LEES

In order to give our readers as up-to-date as possible a picture of recent reports of rare birds, of interesting movements and "invasions", and of other news of general interest, it has been decided to try, as an experiment, a monthly section at the end of each issue of *British Birds* which will have as its aim the dissemination of such information. It must be emphasized straight away, however, that material which appears here is of necessity being published prematurely. In other words, reports will be included here before they have gone the whole gamut of examination and checking that must take place before acceptance and full publication. These items must therefore be regarded as unproven reports and not necessarily as authenticated records;

they will, in fact, be included on the present writer's judgment alone and he will assume full responsibility. The names of observers will not normally be included, partly for reasons of space and partly in case a record is subsequently rejected, and there will be no reference to this section in our annual Index. Finally, if it is to succeed, this scheme needs the cooperation of as many as possible of our readers and so it is hoped that anything of interest will be reported quickly. We felt that, as the last few weeks of the year are usually an unspectacular time for birds, this would be the best point at which to introduce this section, in the hope that the scheme would be working smoothly by the time the spring migration was upon us.

The most interesting recent report concerns what seems to be an immature male Lesser Scaup (*Aythya affinis*) that was first seen at some Berkshire gravel-pits on 15th December, and the almost simultaneous appearance of another drake scaup at Slimbridge, Gloucestershire, which is believed to be of the same species. The Lesser Scaup, which breeds in Canada and winters in southern North America, is not at present on the European list. "Escapes" are unlikely because it is fortunately kept in captivity in only a few known places. The male is distinguished from the drake Common Scaup (*Aythya marila*) by its high-peaked head, smaller size, and darker back and flanks; in addition, many individuals may be distinguished by the fact that they have a pronounced purple sheen to the head (though others have a green sheen, like the common species, and this is one of the reasons for the present uncertainty about the identity of the Slimbridge bird). Both were still present in the middle of January and had by then been seen by some dozens of observers.

This may be the climax to what was a remarkable autumn for American birds in the British Isles. Three months earlier (11th-25th September) a young male Summer Tanager (*Piranga rubra*)—another American species not previously reported in Europe—was trapped and ringed on Bardsley Island in circumstances which suggest that it may be a good candidate for admission to the British list. Pectoral Sandpipers (*Calidris melanotos*) seem probably to have been more numerous during 1957 than ever before and we hope shortly to publish a summary of the records. Other American birds included an American Snipe (*Capella gallinago delicata*) (see pp. 35-36), a White-rumped Sandpiper (*Calidris fuscicollis*), Dowitcher (*Limnodromus griseus*), etc., and, more recently, a Killdeer (*Charadrius vociferus*) was shot at Newquay, Cornwall, on 26th December, a few days after we understand one (perhaps the same bird) had been seen in the Scilly Isles. There have been no records of Killdeers in the British Isles for some years.

Other recent reports of rarities have included a Pallas's Warbler (*Phylloscopus proregulus*) trapped at Holme, Norfolk, on 17th November, there being only two previous British records; a very late Yellow-browed (*Ph. inornatus*) almost a month later at Monk's House, Northumberland; a Black-throated Thrush (*Turdus ruficollis*) on Fair Isle from 8th to 16th December; and an immature White-tailed Eagle (*Haliaeetus albicilla*) at Cley, Norfolk, on 29th December. The invasion of Waxwings (*Bombycilla garrulus*) (see *antea*, vol. I, p. 543) seemed to peter out in early December, probably as a result of the general shortage of berries in the British Isles, as in Scandinavia; this shortage has also affected the apparently larger than usual flocks of Fieldfares (*Turdus pilaris*) and Redwings (*T. musicus*) which were likewise driven out of Scandinavia by lack of food this winter. Lastly it is perhaps worth mentioning that both Eiders (*Somateria mollissima*) and Long-tailed Ducks (*Clangula hyemalis*) have been in unusual numbers further south than usual, and several of each have been reported far inland—Long-tailed Ducks in Bedfordshire, Cambridgeshire, Hertfordshire, Leicestershire, Middlesex, and Staffordshire, and Eiders in Huntingdonshire and Middlesex. There have been no recent further signs of a spread of Collared Doves (*Streptopelia decaocto*) and the situation remains that in 1957 the species bred in four counties—Norfolk, Kent, Lincolnshire and Morayshire—and occurred in several more. A full report on the Collared Doves will be appearing in one of our forthcoming issues.

## NOTICE TO CONTRIBUTORS

*British Birds* publishes material dealing with original observations on the birds of Britain and Western Europe, or, where appropriate, on birds of this area as observed in other parts of their range. Except for records of rarities, Papers and Notes are normally accepted only on condition that the material is not being offered to any other journal. Photographs (glossy prints showing good contrast) and sketches are welcomed. Proofs of all contributions accepted are sent to authors before publication. After publication 20 separates of Papers are sent free to authors; additional copies, for which a charge is made, can be provided if ordered when the proofs are returned.

Contributors are asked to observe the following points, attention to which saves the waste of much editorial time on trivial alterations:

1. Papers should be typewritten with double spacing, and on one side of the sheet only. Shorter contributions, if not typed, must be clearly written and with similar spacing. Failure to help in this way may result in delays to publication.

2. Notes should be worded as concisely as possible, and drawn up in the form in which they will be printed, with signature in block capitals and the writer's address clearly written on the same sheet. If more than one Note is submitted, each should be on a separate sheet, with signature and address repeated. In the case of rarity records, any supporting description which is too detailed for publication should be attached separately.

3. Certain conventions of style and lay-out are essential to preserve the uniformity of any publication. Authors of Papers in particular, especially of those containing Systematic Lists, Reference Lists, Tables, etc., should consult the ones in this issue as a guide to general presentation. English names of species should have capital initials for each word, except after a hyphen (e.g. Siberian Thrush, Yellow-headed Wagtail), but group terms should not (e.g. thrushes, wagtails). English names are those used in *The Handbook of British Birds*, with the exception of the changes listed in *British Birds* in 1953 (vol. xlvii, pp. 2-3). The scientific name of each species should be given (in brackets and underlined) immediately after the first mention of the English name. Sub-specific names should not be used except where they are relevant to the discussion. It is sometimes more convenient to list scientific names in an appendix. Dates should take the form "1st January 1955" and no other, except in Tables where they may be abbreviated to "1st Jan.", "Jan. 1st", or even "Jan. 1", whichever most suits the lay-out of the Table concerned. It is particularly requested that authors should pay attention to Reference Lists, which otherwise cause much unnecessary work. These should take the following form:

TUCKER, B. W. (1949): "Species and subspecies: a review for general ornithologists". *Brit. Birds*, xlii: 129-134.

WITHERBY, H. F. (1894): *Forest Birds: Their Haunts and Habits*. London. p. 34.

Various other conventions concerning references, including their use in the text, should be noted by consulting previous examples.

4. Tables should be numbered with Roman numerals, and the title typed above in the style used in this issue. The title and any headings within the Table should not be underlined, because this sometimes makes it difficult for the Editor to indicate the type to be used. It is most important that the lay-out of each Table should be carefully planned with an eye to its final appearance; above all, it should be borne in mind that Tables must either fit into the width of a page, or be designed to fit a whole page lengthways. All Tables should be self-explanatory.

5. Figures should be numbered with Arabic numerals, and the captions typed on a separate sheet. All line-drawings should be in Indian ink on good quality drawing paper (not of an absorbent nature) or, where necessary, on graph paper, but this must be light blue or very pale grey. It is best if maps, graphs, etc., are drawn twice the size of the final reproduction (ideally, therefore, for the normal 4" width the original should be 8" wide); sketches of birds, however, should be only slightly larger than the size at which it is intended they should appear. It is always most important to consider how each drawing will fit into the page. The neat insertion of lettering, numbers, arrows, etc., is perhaps the most difficult part of Indian ink drawing and, unless he has had considerable experience of this kind of work, an author should seek the aid of a skilled draughtsman. The publishers regret that, owing to rising costs, it will in future be only in exceptional cases that they can undertake to have lettering inserted.



*Leaflet B55/BT  
on request*

Types C.F.18 and C.F.24 (8 × 30.5 mm.) are highly favoured by Bird-watchers, C.F. 24 having an extra wide field of view which is particularly valuable for observing birds in flight. With those who prefer a higher magnification, type C.F. 43 (10 × 42 mm.) is a firm favourite.

# *Binoculars by* **BARR & STROUD Ltd.**

ANNIESLAND, GLASGOW, W.3 — London Office: 15 Victoria St., S.W.1

*Printed in Gt. Britain by WITHERBY & Co., LTD., WATFORD, HERTS.  
Published by H. F. & G. WITHERBY, LTD., 5, WARWICK COURT, W.C.1.*



# BRITISH BIRDS



FEBRUARY 1958

THREE SHILLINGS

# BRITISH BIRDS

AN ILLUSTRATED MONTHLY MAGAZINE

Edited by

E. M. NICHOLSON

W. B. ALEXANDER                      A. W. BOYD

I. J. FERGUSON-LEES

P. A. D. HOLLON                      N. F. TICEHURST

*Editorial Address* : 30, St. Leonard's Avenue, Bedford.

*Photographic Editor*: G. K. YEATES

Annual Subscription £2 (including postage and despatch)

---

CONTENTS OF VOLUME LI, NUMBER 2, FEBRUARY 1958

---

	PAGE
The birds of Tiree and Coll. By Dr. J. Morton Boyd (plates 18-20). ( <i>To be concluded</i> ) ... ..	41
British recoveries of birds ringed abroad. Communicated by Miss E. P. Leach ... ..	57
Photographic studies of some less familiar birds. LXXXV—Pygmy Owl. Photographed by Kurt Ellström, Sigvard Rosén and Enar Sjöberg (plates 13-16). Text by Dr. Kai Curry-Lindahl ... ..	72
Reports from Britain of Black-headed Gulls ringed in the Oberlausitz, East Germany. By Dr. Wolfgang Makatsch. Accompanying photograph by Mrs. Ilse Makatsch (plate 17) ... ..	74
Notes:—	
Leach's Petrels in Shetland (D. R. Wilson) ... ..	77
Honey Buzzard in Lancashire (David Redhead) ... ..	78
Spotted Crake in Oxfordshire in July (D. F. Owen) ... ..	78
Spotted Crake in Cheshire in July (A. W. Boyd) ... ..	78
Mating display of Snipe (A. W. Boyd and E. M. Nicholson) ... ..	79
White-rumped Sandpiper in Yorkshire (J. R. Mather and R. F. Dickens) ... ..	80
The field-identification of Baird's and Semi-palmated Sandpipers (P. W. P. Browne) ... ..	81
Ruffs displaying in a wintering area (D. I. M. Wallace) ... ..	81
Rooks taking sand (Mrs. J. B. Cowdy) ... ..	82
Willow Warbler's unusual song and display-flight (Bernard King) ...	83
Review:—	
<i>Ornamental Waterfowl</i> . By Lt.-Col. A. A. Johnson and W. H. Payn	83
Recent reports and news. By I. J. Ferguson-Lees ... ..	84

---

Cover photograph by Sigvard Rosén: Pygmy Owl (*Glaucidium passerinum*)  
on mouse in snow



## BRITISH BIRDS

### THE BIRDS OF TIREE AND COLL

By J. MORTON BOYD

(*Department of Zoology, Glasgow University\**)

(Plates 18-20)

THE islands of Tiree and Coll, Inner Hebrides, lie totally within the vice-county Mid Ebudes (103). Situated between Mull and the Barra Isles, they stretch some 45 miles S.W. into the ocean from Ardnamurchan, the most westerly headland of the Scottish mainland. Their geographical position, and separate scale maps of each, are shown in Figs. 1, 2 and 3. This work is concerned with records of all species of bird observed, from the earliest literature to the present day, not only on Tiree and Coll, but also on all islands and rocks between and including Eilein Mor, N.E. of Coll, and Skerryvore, S.W. of Tiree.

The islands are a low undulating platform of Lewisian gneiss masked extensively by raised beach material and wind-blown sand. The sand deposits are particularly widespread in Tiree and S.W. Coll, but in N.W. Coll there are considerable tracts of bare rock. The terrain rises to its highest point (460 feet) in Ben Hynish, Tiree.

The principal ecological divisions of the islands are: (i) an intertidal zone, including extensive beaches of shell-sand interspaced with rocky shores trenched by eroded dykes, and fringed with skerries; (ii) grazed sand-dune systems landward to the shore sand, and moorland altered by salt-spray landward to the rocky shores (the only substantial sea-cliffs are at Ceann a'Mhara, Tiree); (iii) *machair* or sea-meadow, and cultivated calcareous grassland covering wide tracts of Tiree and S.W. Coll; (iv) grazed moorland of mixed grasses, sedges and heather, covering central areas of both islands; (v) lightly grazed heather moorland, covering parts of the interior of Coll; (vi) fresh-water lochs, streams, ditches and marshes form a web over all other ecological zones from the alkaline to the acid ground, and give rise to small brackish estuaries. The beaches, dunes, *machair* and cultivation, moorland,

\*Now Nature Conservancy, Edinburgh.

lochs and ditches are all well brought out in the aerial photographs on plates 18-20. With the exception of a few small plantations of deciduous trees in Coll, and a few trees growing in the lee of croft-houses in Tiree, the islands are almost treeless. Whin and bramble thickets grow locally and provide good cover for birds.

The islands are dominated by a S.W. air stream, moist, warm, and with high winds. Gusts of 108 m.p.h. have been recorded. The

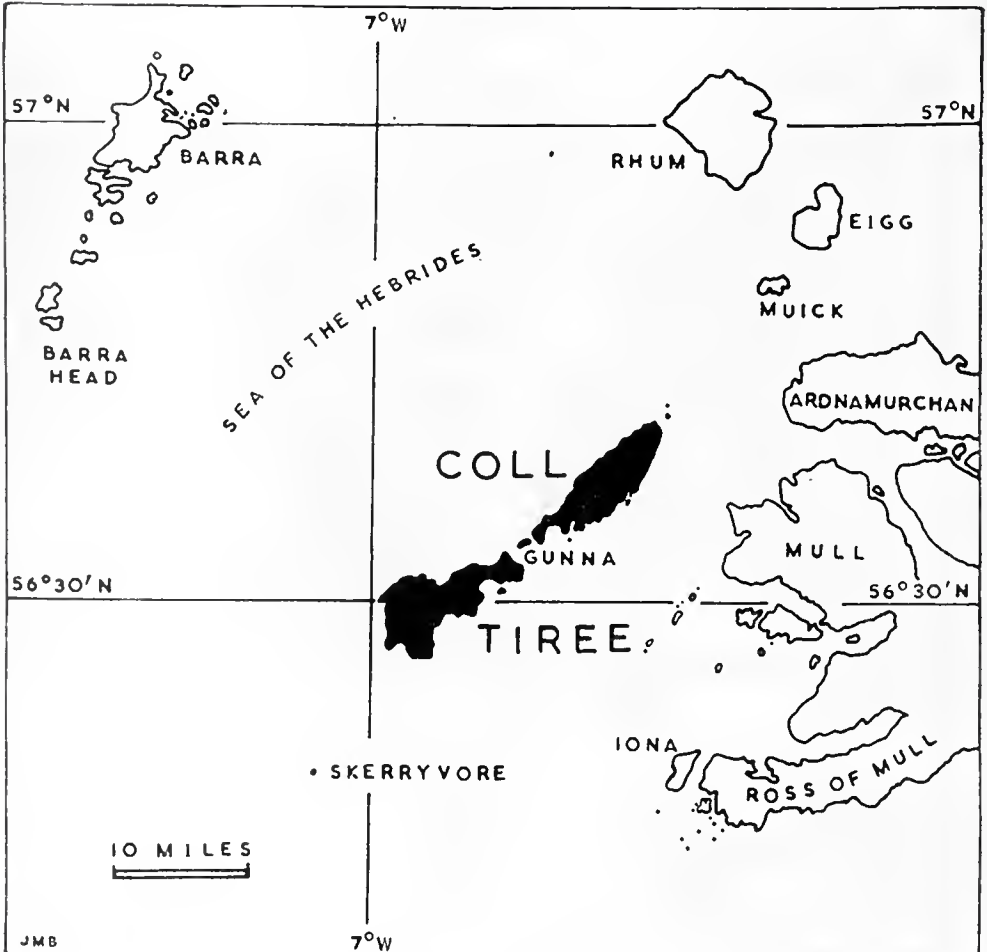

FIG. 1—MAP TO SHOW POSITIONS OF COLL AND TIREE IN RELATION TO BARRA, MULL, AND ARDNAMURCHAN ON THE SCOTTISH MAINLAND

temperature range is some 3 degrees Fahrenheit less than the Scottish West Highlands, and 6 degrees Fahrenheit less than the Scottish mainland generally. Snow seldom lies more than a few days in the year, and the soil remains open practically all winter. Hours of sunshine are somewhat similar to those of southern England; in May 1948 Tiree had an average of 10.6 hours of sunshine daily.

Outstanding features of the fauna (particularly related to the ecology of the avifauna) are: (i) the abundance of snails, bivalves

and slugs in the calcareous fresh waters and grasslands; (ii) the aggregation of fly larvae, ants, beetles and earthworms in cow-pats on all grasslands and moorlands; (iii) the presence of Rabbits (*Oryctolagus cuniculus*) in Coll, and their absence in Tiree (see notes on the Buzzard and compare plates 18 and 19); (iv) the presence of the Hare (*Lepus europaeus*), the Long-tailed Field Mouse (*Apodemus sylvaticus*), the Brown Rat (*Rattus norvegicus*)

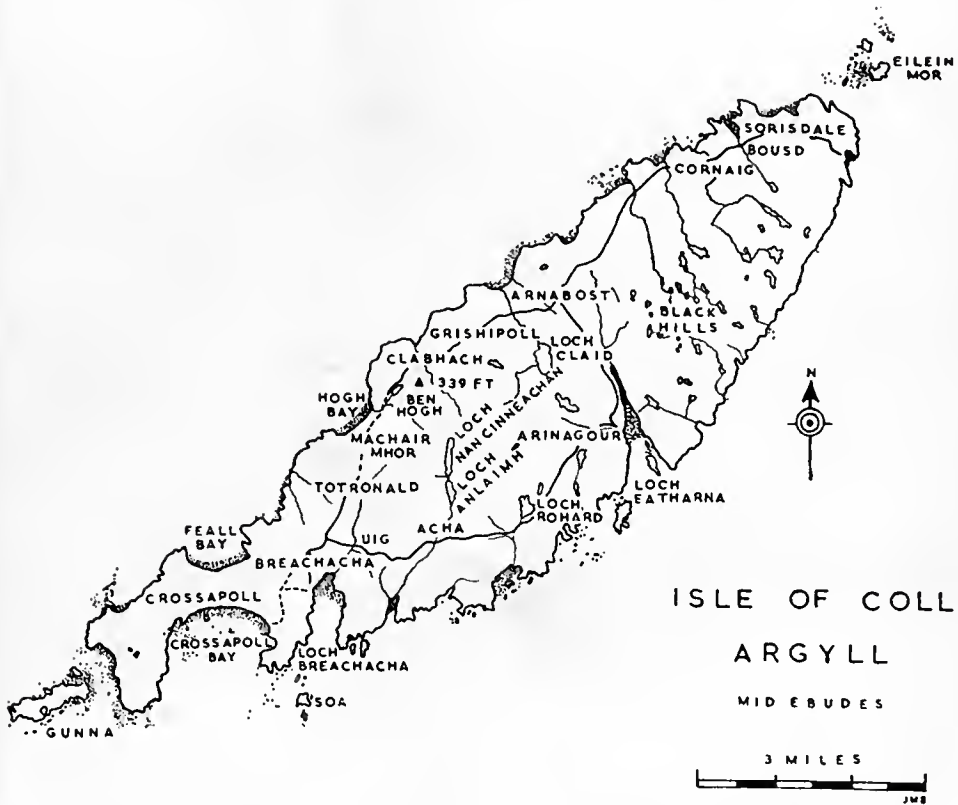

FIG. 2—MAP OF THE ISLE OF COLL TO SHOW PRINCIPAL PLACE-NAMES AND THE POSITIONS OF EILEIN MOR AND GUNNA (cf. Fig. 3)

and the Pygmy Shrew (*Sorex minutus*); (v) the presence of the Brown Trout (*Salmo trutta*) and the Three-spined Stickleback (*Gasterosteus aculeatus*) in fresh waters, and the absence of amphibians and reptiles.

The agricultural system in Coll is farming (the major farms are named in Fig. 2), while in Tiree it is crofting (the crofting townships are named in Fig. 3). According to the *West Highland Survey* (Darling *et al.*, 1955), in 1951 the human population in Coll was 200, and that of Tiree 1,200.

Casual mention of the avifauna of these islands is made in the *Statistical Account of Scotland* (1791-1799), but the first comprehensive record appears in *A Vertebrate Fauna of Argyll and the Inner Hebrides* (1892), by J. A. Harvie-Brown and T. E. Buckley. This volume stimulated interest, and in 1898

P. Anderson, the game-keeper of Tiree at that time, published the first separate list of the birds of Tiree, to be followed in 1899 by a supplementary list for both Tiree and Coll, by Lieut.-Col. L. H. Irby. Reports of movements and occurrences of birds in Scotland in 1897 and 1898 (Laidlaw, 1898 and 1899) include information from Tiree and the Skerryvore, and a separate list later appeared for Skerryvore (Tomison, 1907). In 1913

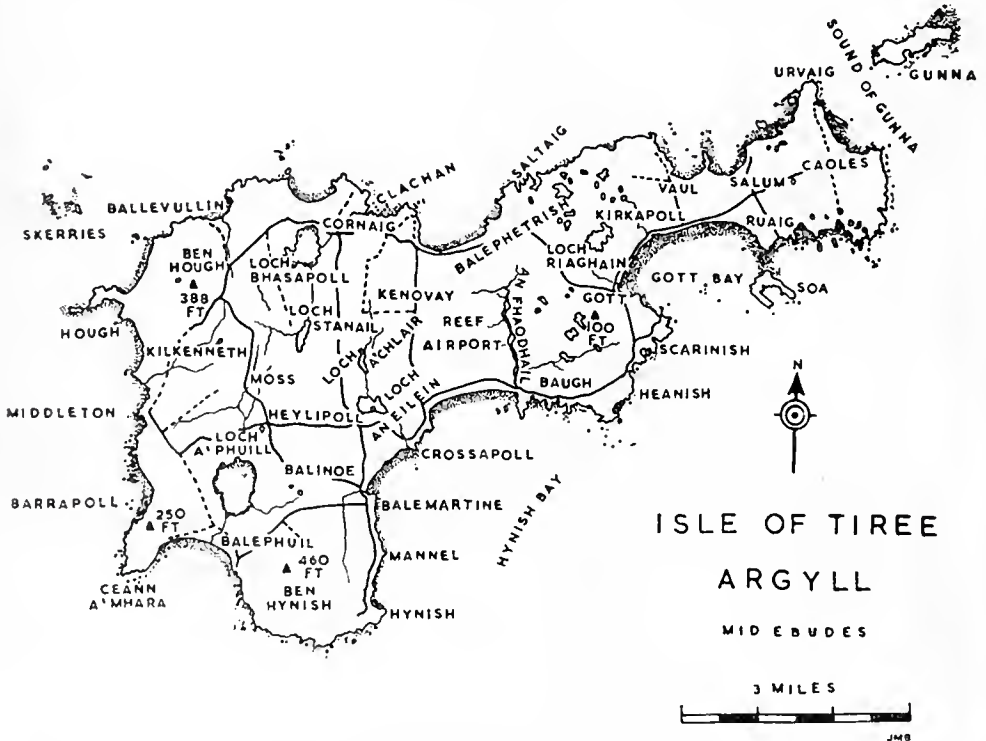

FIG 3--MAP OF THE ISLE OF TIREE TO SHOW PRINCIPAL PLACE-NAMES AND THE POSITION OF GUNNA (cf. Fig. 2)

Anderson published his second list for Tiree summarizing over 25 years' observations on that island. Thereafter no lists were published for Tiree, and none for the area till Miss MacDougall's list for Coll in 1938. Miss Baxter and Miss Rintoul, in *The Birds of Scotland* (1953), brought together much information on Tiree and Coll based mostly on the out-dated literature, and a great deal of this is now supplemented by information acquired mainly in the last 10 years from numerous reliable observers. From time to time since 1892, short notes on the birds of the area have appeared in the *Annals of Scottish Natural History* and the *Scottish Naturalist*.

The author desires to make the following acknowledgements with thanks. His Grace the Duke of Argyll kindly gave access to the game-record of the Tiree Estate. Lists for Tiree were supplied by H. A. Course, James Fisher, D. Gardner-Medwin, J. Graham, N. Hopkins, N. McIntyre, J. Murray (Edinburgh

Academy Party, 1954), C. F. Priestley, W. C. Taunton, Iolo Williams, and J. T. D. Wilson. Lists for Coll were supplied by A. G. S. Bryson, W. P. Colyer-Fergusson, J. R. Furse, Miss M. Henderson, C. K. M. Stewart, and A. A. K. Whitehouse. Short notes were supplied by W. K. Richmond and L. A. Urquhart. R. Roddam assisted in recent sea-bird counts. Mrs. W. I. Boyd assisted both in the field and in sifting the literature. Dr. J. W. Campbell kindly sent information originally lodged with the Editors of the *Scottish Naturalist*. Requests for information, all of which brought response, were published in *Bird Study*, the *Edinburgh Bird Bulletin*, and the *Glasgow and West of Scotland Bird Bulletin*.

The notes of the author have been made from some 25 visits to Tiree at all seasons, 1 to Coll in summer, 1 to Skerryvore in summer, and 3 to Gunna, summer, autumn and winter, in the period from June 1952 to June 1957. Many of those visits were made in connection with ecological research in Hebridean soils assisted by a grant from the Nature Conservancy, which made possible countless casual observations on birds.

#### SPECIFIC LIST

In this list frequent reference is made to the published works on the birds of Tiree and Coll, particularly those which appeared in 1892, 1898, 1899 and 1913 (see pages 43-44). Since many of the remarks in these publications refer not only to those particular years, but also to the ones preceding them, these dates are placed in brackets in such cases.

For each species the treatment follows the same plan: a short phrase summing up the seasons when it is present; a review of the breeding records, from Tiree, Coll and the other islands separately; and, lastly, a similar review of the status during the rest of the year, again with separate treatment where this is needed.

**BLACK-THROATED DIVER (*Gavia arctica*).**—Present all year. Bred in Coll 1899, but no breeding record from Tiree. Mature birds seen regularly April to July off both islands 1954-55, but no recent breeding record or report from fresh waters.

**GREAT NORTHERN DIVER (*Gavia immer*).**—August to May. No breeding record. Seen off-shore since September 1888; November to April 1903-06 at Skerryvore; similarly 1952-55 off Tiree and Coll. No report from fresh waters.

**RED-THROATED DIVER (*Gavia stellata*).**—Present all year. Bred in Coll before 1899; bred there 1937-38; 8 pairs with young July 1939; present August 1945; June 1946, 1949; May 1954; April, June 1955; increasing 1956 (W.P.C.-F.). No breeding record from Tiree, and has only twice been reported from fresh waters. Seen off Tiree, September 1956.

**GREAT CRESTED GREBE (*Podiceps cristatus*).**—January to June. No breeding record. Seen in Tiree January 1891; 2 pairs in breeding plumage 22nd May 1900; 1 pair May-June 1952. No record from Coll.

**RED-NECKED GREBE (*Podiceps griseigena*).**—Spring. Reported from Tiree as common and not breeding (J.T.D.W.). No record from Coll.

SLAVONIAN GREBE (*Podiceps auritus*).—October to April. No breeding record. One shot in Tíree 7th November 1888; seen there 29th October 1898; common there (1913); seen Soa Sound 7th April 1954. No record from Coll.

LITTLE GREBE (*Podiceps ruficollis*).—Present all year. Bred in Tíree 1865 (Gray, 1871), 1913, 1950, but reported as common in winter and spring on fresh waters and the sea. Breeding not proved in Coll, but 1 pair was seen twice in June 1938, and at Loeh Ballyhogh and Loeh Callum in July 1939.

LEACH'S PETREL (*Oceanodroma leucorhoa*).—Autumn. Reported from Tíree October 1891 and 1953, after gales.

STORM PETREL (*Hydrobates pelagicus*).—Summer and autumn. A visitor to the sea area since before 1892, but no conclusive evidence of breeding. Fairly common off Ceann a' Mhara in daylight; 1 dead in Tíree September 1889; another January 1901; at Skerryvore August/September 1903-06, and again July 1955. The presence of Brown Rats (*Rattus norvegicus*) in Gunna, Coll, and at Ceann a' Mhara is probably a deterrent to breeding.

MANX SHEARWATER (*Procellaria puffinus*).—April to September. A visitor to the sea area since before 1892 when they were said to be decreasing. No conclusive evidence of breeding, though some suitable burrows have been found at Ceann a' Mhara. Numerous in spring and summer at Skerryvore 1903-06, and have been particularly so in recent years off the east coasts of both islands.

GREAT SHEARWATER (*Procellaria gravis*).—Autumn. One dead in Tíree October 1891; 2 off-shore there August 1919; and another found dead October 1951. None reported from Coll.

SOOTY SHEARWATER (*Procellaria grisea*).—Only record is of two off-shore Tíree May 1948 (C.F.P.).

FULMAR (*Fulmarus glacialis*).—April to September. Breeding at Ceann a' Mhara. None 1912 or 1913; about 6 present 1925, but left during the breeding-season; 6 nests 1929; 30 nests 1933; 74 pairs July 1942; 185 occupied nests May-July 1944; 110 nests with another 20 pairs present mid-June 1946; 171 pairs and 160 eggs in late June 1947 (J.F. and others); 200-300 pairs early June 1949; 300 birds May-June 1952; 650 birds early April 1954; 250 birds late April and mid-June, 193 pairs in early July, and 160 young with no brooding adults in late July 1955 (J.M.B. and others). No record from Coll.

GANNET (*Sula bassana*).—Present all year. Not breeding. More common in sea area in summer than in winter.

MAGNIFICENT FRIGATE-BIRD (*Fregata magnificens*).—A bird of the Caribbean race (*F. m. rothschildi*) found exhausted in Tíree 9th July 1953 (J.G.; *antea*, vol. xlvii, pp. 58-59; and Stephen, 1953).

CORMORANT (*Phalacrocorax carbo*).—Present all year. Baxter and Rintoul (1953) say that it breeds in small numbers in Tíree, but although pairs of birds have been seen off-shore from June to August breeding has not been proved. At Skerryvore 1903-06 August till February, but not in breeding-season. In Coll, 20 roosted in May 1937; one or two off-shore July and August 1939, and late April 1955; 1 in June 1955. In Tíree, present June 1949; a few pairs June and July 1952; single birds April 1954; single birds March, April and June 1955.

SHAG (*Phalacrocorax aristotelis*).—Present all year. Has bred at Ceann a' Mhara since before 1898; bred 1912 and 1913; 30 birds there late July 1942; at least 25 nesting May 1952; eggs seen April 1954; at least 12 birds with eggs and young June and July 1955. It is reported to have nested near the Sound of Gunna (N. McL.). No breeding record is available for Coll. Irby (1899) fails to mention its presence in the area, but all observers since have reported it as numerous around the coast, being seen ashore on the steeper S.E. side. Flies through the Sound of Gunna in winter in large numbers to and from roosts in the Treshnish Isles. At least 415 entered the sound flying east in 15 minutes before sunset in mid-December 1955.



**HERON** (*Ardea cinerea*).—Present all year. Bred Arinagour, Coll, before 1899; 2 pairs bred there in 1929; seen and said to have bred July 1939; similarly August 1945; present June 1946, and 1949; courtship reported late April 1955 with possible nesting-site at Blackhill Lochs; 2 seen June 1955. No breeding record from Tiree, but seen there May 1952, and April 1954; 1 seen 9th-12th July 1955. Common autumn to spring, usually as single birds, both inland and on rocky shores. Seen on passage at Skerryvore August 1903-06.

**GLOSSY IBIS** (*Plegadis falcinellus*).—One reported 21st February 1901 (Robinson, 1914).

**MALLARD** (*Anas platyrhynchos*).—Present all year. Recorded as breeding plentifully, beginning usually in late March, in both islands before 1899. Reported as abundant in Tiree (1913), nesting all over the island; spring and summer observers there 1949-55 report small numbers, common, and fair numbers. In Coll 1937-55 breeding-season reports have been "plentiful", "common", and "fairly evenly distributed". Distinctly more numerous in winter, being mainly marine and flighting to fresh waters at high tide, flocks usually up to 20. Scarce in both islands 1956.

**TEAL** (*Anas crecca*).—Present all year. Bred in both islands before 1899. Bred all over Tiree (1913), beginning in late April; a few breeding pairs, single birds and nests May to August 1952-55, though Baxter and Rintoul record it as nesting numerously all over Tiree in 1950. In Coll, 2 pairs were reported May 1937; only 3 seen July and August 1939; seen occasionally August 1945; a few May 1954; flocks and a pair late April 1955, and one June 1955. Flocks usually up to 50 strong are present in the rocky weedy bays and on the major lochs of Tiree, September to April.

**GADWALL** (*Anas strepera*).—Present all year. Only evidence of breeding is 2 adults with 10 fledged young, late August 1913, and a duck with 3 unfledged young in late July 1955 (J.M.B., W.I.B.). Between 1870 and 1900 Gadwalls were numerous in Tiree in winter, flocking on the sea, probably in the fashion of Teal and Wigeon at the present day. The species used to arrive (Anderson, 1913) at the end of harvest time and stay till late spring; in 1913 it was still common winter and spring; subsequently it has become scarce and is not included in the list of common wildfowl (J.G.). The only other recent records are "numerous" on Loch a' Phuill, January 1949, and odd birds seen at 5 different sites on 4 different days, early April 1954. No record from Coll.

**WIGEON** (*Anas penelope*).—September to April. Bred in Coll 1892; 2 drakes seen there May 1937; 1 duck June 1938. In 1913 an odd bird was known to remain over the summer in Tiree, thought to be wounded, but none has been reported subsequently in summer. Has always been numerous in winter, more so in some than in others, since before 1892. Flocks, which seldom exceed 50 birds, at present frequent the rocky shore inlets and fresh waters in Tiree.

**PINTAIL** (*Anas acuta*).—Present all year. Bred in Tiree 1951 (Bennett, 1952), and may have bred 1938, a female in down feathers having been sent to the British Museum; ducks reported there June 1952 and July 1955. Has occurred in winter and spring in small numbers since 1879; occurred sparingly on migration in Tiree, 1898; in small parties during the winter there, 1913; 1 pair seen February 1953; small flocks, largest numbers together 7, early April 1954; 1 pair seen mid-January 1956. No record from Coll.

**SHOVELER** (*Spatula clypeata*).—Present all year. Young shot in Tiree 1887; a few pairs bred (1898); increasing as a breeding species (1913); a pair in Tiree and another in Gunna, June 1949; several seen May-June 1952; small flocks, largest number together 6, and pairs, April 1954; at least 20 young birds seen July 1955; nesting proved in recent years beside Loch Garradh a' Chapuill, Tiree. The only record from Coll is 2 drakes 10th May 1937. Occurs in small flocks, usually less than 6 strong, September to April. Anderson (1913) says that in about 25 years of observation in Tiree he has not noticed

this species on the shore, but it is reported from the weedy shore inlets, April 1954, November 1954, February 1955.

**SCAUP** (*Aythya marila*).—September to spring. No breeding record, but a newly fledged duckling was seen in Tiree in August (Anderson, 1913). A large flock was seen in Tiree, June 1891, and before 1887 the species wintered in considerable numbers there; common in winter (1898 and 1913), with migration from September to November; no recent definite records are available, and in the course of numerous visits to Tiree, autumn to spring, the author has seen none. No record from Coll.

**TUFTED DUCK** (*Aythya fuligula*).—September to June, perhaps all year. A few pairs bred in Tiree (1892 and 1898); then breeding discontinued (1913); 1 pair and a drake with 2 ducks seen in west Tiree on different occasions, June 1946-52 (N.Mc.I., H.A.C.); a duck with 2 ducklings Loch a'Chlair June 1957 (J.M.B., Donald Watson). A regular winter visitor since before 1892 to both Tiree and Coll; common (1898 and 1913); common 1953-55, flocks not usually exceeding 70 birds, frequenting both sea and fresh waters.

**POCHARD** (*Aythya ferina*).—Winter. Harvie-Brown and Buckley (1892) report 2 drakes seen in Tiree 12th June 1891; a few pairs bred up to 1898, but probably discontinued by 1913; one drake Loch Bhasapoll June 1957. A small flock was reported 12th November 1887; numerous in winter, 1898; fairly numerous 1913; only recent records are 1 drake December 1953, and another early April 1954. No record from Coll.

**GOLDENEYE** (*Bucephala clangula*).—October to April. No breeding record. Common in winter (1892, 1898, and 1913); small flocks usually less than 20 strong November to April 1952-56. Anderson (1913) reports only single birds on both sea and fresh waters, most numerous January and February.

**LONG-TAILED DUCK** (*Clangula hyemalis*).—October to April. No breeding record. Reported as common or very common 1892-1913; common, more so off the N.W. coasts than the S.E., October-April 1952-56. Seen on fresh waters (1913), but not recently. The usual flock size in 1913 was about 6, while during 1952-56 as many as 30 have been seen together, the usual flock size being about 12 birds. Anderson (1913) also says that the birds disappear about the end of March; common in N.W. bays Tiree, 9th April 1954; 2 flocks, about 30 birds in each, were seen in separate bays in Coll, 21st April 1955.

**COMMON SCOTER** (*Melanitta nigra*).—Present all year. Bred in Tiree in 1897, and probably before then, a duck in down plumage having been reported 22nd August 1889. One seen in Sound of Gunna August 1945; present Tiree, August 1954. Common off Tiree 1857; seen there May 1889; fairly common but never numerous (1898); not at all numerous (1913). Baxter and Rintoul (1953) record the species as common, having increased and become abundant, flocks lingering far into the summer. Only 3 of the 11 available lists for the period 1945-55, April to August, mention its presence. Off Tiree 3 birds were seen February 1954, and groups of up to 10 in September 1956. No recent winter record from Coll.

**EIDER** (*Somateria mollissima*).—Present all year. Bred in Tiree and Coll before 1871; common breeding (1892); abundant (1898 and 1913); common breeding 1937-39, and again 1945-55. During the breeding-season large flocks mainly composed of drakes occur off-shore. Bred in Gunna, 1949, when 5 nests were found. Numerous in winter especially off the N.W. coasts and in the Sound of Gunna, flocks of up to 50 birds being common. Has not been reported from fresh waters in Tiree, but was found at lochs in Coll 1937-38.

**RED-BREASTED MERGANSER** (*Mergus serrator*).—Present all year. Bred in Tiree before 1871, and in Coll before 1899; abundant (1913); reported as plentiful from both islands 1937-55, May to August, pairs and young having been seen. Breeds inland sometimes well away from water, and flocks of probably up to 200 occur on the sea during late summer. A flock about 150 strong was present in Gott Bay, Tiree, July 1955, composed mostly of immature

birds. Small flocks occur off-shore, September to March, and groups of 1-3 birds on fresh waters.

**GOOSANDER** (*Mergus merganser*).—No recent record, but Anderson reported it as seen at all seasons (Harvie-Brown and Buckley, 1892). By 1898 and 1913 the species had become scarce. There is no breeding record, nor any record since 1913. No record from Coll.

**SMEW** (*Mergus albellus*).—Anderson (1898) reported it as common autumn to spring in the sea but never in fresh waters. They were especially common in Gott Bay. Reported 7th September 1897, 30th July and 14th November 1898 and 16th January 1901. No recent record, Tiree; no record from Coll.

**SHIELDUCK** (*Tadorna tadorna*).—Present all year. Numerous in Tiree and Coll before 1871; bred in both islands (1899); common but not abundant in Tiree (1913). Fair numbers bred in Tiree 1949-55, nests, pairs and families seen April to August. In Coll it was a common breeding species 1937-38; 1 family only, July and August 1939; 2 pairs almost certainly with nests June 1946; pairs in every bay late April 1955; 1 pair off shore, and 1 bird in sand-dunes, June 1955. One pair was seen in Gunna, early June 1949. Nests have been found about 1 mile from the shore. Pairs and groups of 3-6 winter on the shore, and are especially numerous at Clachan Bay, Tiree, where at least a dozen were present in several small parties, winter 1954-55.

**GREY LAG GOOSE** (*Anser anser*).—Has been reported at all seasons, but mainly in winter. In 1932 H. W. Robinson wrote that he was informed of breeding both in Tiree and Coll many years before that date, and in 1954 N. McIntyre stated that it once nested unsuccessfully in Tiree "a number of years ago". In Tiree single birds were seen at 2 different sites May to July 1952, and it was present August 1954; 17 present in mid-summer and in September 1956. In Coll a pair bred 1937-38 (Macdougall, 1938); 2 or 3 pairs said to have bred since 1935, but not seen 1939 (A.G.S.B.); 2 seen August 1945; flocks of 25 and 5, 1 pair, and a single bird, late April 1955; 17 in August 1956, with probably 2 breeding pairs (W.P.C.-F.). A rare passage migrant in Tiree (1892); "occurs occasionally in winter, but does not stay long" (1898); reported sparingly on migration with a few in winter (1913); 2 flocks of 10 and 12 seen January 1949; 32 seen February 1951; two flocks of 12 (possibly the same flock seen twice) present late December 1952; 31 early March 1953; 7 in January 1954; 11 on 25th February 1955. A recent winter increase has occurred in Coll; 40 have appeared regularly, and as many as 90 have been seen, 1955-56.

**WHITE-FRONTED GOOSE** (*Anser albifrons*).—October to May. Not breeding. It was the exception to see this species in Tiree (1892); reported there 8th-11th May and 15th October 1897; common (1898); 400-500 wintered regularly about 1913; probably not more than 250 were present October to April 1952-56, flocks usually over 50 and less than 150 strong. Irby (1899) said the species was more common in Tiree than Coll, but the only recent winter record available from Coll for comparison is of 13 seen on the south end on 7th February 1953. All the birds are probably of the Greenland race (*A. a. flavirostris*), arriving from and departing to the N.W.

**BRENT GOOSE** (*Branta bernicla*).—Winter. Rare in Tiree (1892); occurred sparingly during hard frost (1898); seen late October 1909; a flock of 14 seen during frost in early February 1912; 1 seen autumn 1949; a pair, thought to be of the Dark-breasted race (*B. b. bernicla*), November 1955 in mild weather. No record from Coll.

**BARNACLE GOOSE** (*Branta leucopsis*).—November to May. Baxter and Rintoul (1953) say that it has been the dominant species of goose in Coll for the past 50 years, outnumbering the grey species by 5 to 1; though abundant in Coll, not so in Tiree in 1892 and 1899; small flocks of about 12 birds in Tiree (1898); small flocks there 1913; flocks of 350-400 seen in Tiree January 1948 and March 1950; 250-350 February 1951; 250-300 December 1952,

February 1953, October-March 1954-55; 12 were seen on 19th May 1956. In Coll, 120 were seen February 1953; 200-300 in late April 1954. In Gunna, 35 were seen February 1953; 150 mid-November 1955. In recent years probably less than 350 have wintered regularly in Tiree and Coll. These are concentrated in Gunna, roosting there and ranging the N.W. shores usually as far as Balephetrish, Tiree, and Arnabost, Coll. Flocks also frequent Breachacha and Soa. In spring the resident flock is sometimes augmented by migrants, probably raising numbers to over 400 occasionally.

CANADA GOOSE (*Branta canadensis*).—One shot in Tiree (Anderson, 1913).

MUTE SWAN (*Cygnus olor*).—Present all year. First bred in Tiree 1909; at least 1 or 2 pairs bred there 1949, 1950, 1952, 1954-56 and probably in intervening years. Bred in Coll (Baxter and Rintoul, 1953); 2 pairs present there 1937; 1 pair 1938; 1 pair July and August 1939; "numbers" August 1945, June 1946 and 1949; none May 1954, April 1955, June 1955. A single straggler was reported from Tiree 1898, but none from Coll before 1899; 17 seen Tiree 1908; 75 there 1911; during 1952-56, 50-100 birds probably summered in the islands, with 10-20 wintering.

WHOOPEE SWAN (*Cygnus cygnus*).—Present all year. No breeding record, but a few mature birds have been reported summering in Tiree, June 1947-50, June and July 1952, mid-May 1954, June and July 1955. "Wild swans" recorded from Tiree and Coll 1794; increased in Tiree from 12, 1886, to about 200, 1898, in winter; considerable but varying numbers there about 1913, arriving usually in late October with numbers increasing till late November; about 40 present early April 1954; common in winter 1952-55, usually more than 100 frequenting the fresh waters and marshy meadows. Five birds reported from Coll late April 1955, and the species probably winters there in small numbers.

BEWICK'S SWAN (*Cygnus columbianus bewickii*).—Winter and spring. No breeding record. Tiree was perhaps this bird's principal settling ground in Argyll and the Inner Hebrides (1892); increasing (1898); arriving usually in November, as many as 200 were recorded at Loch an Eilein, Tiree, in 1897; "crowds" November 1908; numerous (1913); seems to have remained fairly numerous in Tiree in winter till the 1939-45 war; only recent record is of 3 in Tiree, April 1954.

BUZZARD (*Buteo buteo*).—Present all year. Bred in Coll 1938 (Macdougall, 1938); young seen there 1945-49. Bred in Tiree 1950 (Baxter and Rintoul, 1953). All recent summer observers in both islands mention the presence of the species there and also in Gunna and Soa off Tiree. No mention in lists for 1898, 1899, and 1913, but increased as a breeding and wintering species 1938-54. No rabbits have been present in Tiree for the last 100 years and perhaps not at all, but in Coll the advent of myxomatosis has killed off most of the rabbits there since 1954, though in November 1956 they were again on the increase. In Coll in 1956 the Buzzard population was approximately half of what it was in 1954, and they were seen to prey on young duck and small birds. There is a record of an attack on domesticated puppies and Buzzards were also seen in pursuit of Teal, like falcons (W.P.C.-F.). Probably less than 10 pairs now breed in the area, most of them unsuccessfully due to human interference. Breeding proved in Tiree, May 1956. Common in winter, usually singly, 1952-56; 6 seen together in Tiree, April 1954; 3 seen together there, January 1955; found feeding there on a Lapwing (killed by car), a hare (probably shot) and an immature Herring Gull in mid-winter 1955-56.

HEN HARRIER (*Circus cyaneus*).—Winter. Was observed in Coll before 1899, and in Tiree November 1955.

PEREGRINE (*Falco peregrinus*).—Present all year. In 1343, falcons' eyries were present in Coll and Tiree (Baxter and Rintoul, 1953), and the bird bred in both islands (1899). It bred annually at Ceann a' Mhara, Tiree, 1900-13, and it has bred there occasionally since (N.McI., J.T.D.W.); one seen in Tiree

late May 1952 and mid-July 1955. None seen in Coll summer 1937-38; seen there twice in July and August 1939; 1 reported 18th April 1955. One at Skerryvore 26th September 1903; and odd birds seen from September to February 1948-56, in Tiree.

**GREENLAND FALCON** (*Falco rusticolus candicans*).—One seen 6th February 1901 (H. W. Robinson, 1914).

**MERLIN** (*Falco columbarius*).—Present all year. Bred in both islands before 1899. Bred in Tiree (1913), 1930 and probably 1954. Bred in Coll 1937, and probably 1954-55. Very numerous following immigration of thrushes in autumn 1898; common except in summer, but never entirely absent from Tiree, 1913; common September to April, 1952-56.

**KESTREL** (*Falco tinnunculus*).—April to February, possibly all year. Bred in both islands before 1899; not at all common in Tiree (1913); but seen there June 1952 and July 1955. Reported from Coll in July 1939, August 1945 and June 1946. Seen in both islands April 1954-55, and in Tiree from November to February 1948-55, and September 1956.

**RED GROUSE** (*Lagopus lagopus scoticus*).—Present all year. Bred Coll before 1899 and during 1937-39; nearly wiped out by heath fires 1939-45; heard 1945-46, but not 1949. Not reported from Coll by 3 different observers at different times, April to June, 1954-55. About 20, mostly old birds, remained in 1956 (W.P.C.-F.). No record from Tiree.

**PARTRIDGE** (*Perdix perdix*).—Both English and Hungarian Partridges were introduced into Tiree, and bred there as early as 1891, but were extinct by 1912. Reintroduced into Tiree in 1935, the species was again extinct by 1939. Bred in Coll before 1899; bred there, and bags of 200-300 obtained, 1937-39; a covey seen August 1945; not reported 1954-55; none 1956 (W.P.C.-F.).

**QUAIL** (*Coturnix coturnix*).—One seen in Tiree before 1898, and another there early July 1955 (W.K.R., R.R., J.M.B., W.I.B.). No breeding record. No record from Coll.

**PHEASANT** (*Phasianus colchicus*).—Present all year. Introduced in 1935 into Tiree, where nests have been reported. Heavily shot during 1939-45 war, but still survives. The game-record of the Tiree Estate records 58 shot between August 1946 and February 1955, and 8 were killed in a shoot in November 1955. Introduced into Coll 1937-38, but not recorded by subsequent observers. Perhaps 1 left, November 1956 (W.P.C.-F.).

**WATER RAIL** (*Rallus aquaticus*).—Winter. Recorded in 1898 as fairly numerous in winter in Tiree; and a few used to remain there to breed (1913). One recorded November 1897; and another November 1954.

**SORA RAIL** (*Porzana carolina*).—On 25th October 1901 a young male was shot in west Tiree. No other record.

**CORNCRAKE** (*Crex crex*).—May to September. Has been numerous in Tiree since 1794. Observers in Tiree in 1892, 1898, 1912, 1913 and 1949-55 report it as an abundant, common, or fairly common breeding species. Bred in Coll before 1899; 12 pairs estimated 1937; one found dead 1939; bred 1945, 1946, 1949; present 1954-55. Seen on passage at Skerryvore on 21st May 1898, 14th September 1904 and 12th September 1906.

**MOORHEN** (*Gallinula chloropus*).—Present all year. Bred in Tiree and Coll before 1899. Bred in Tiree (1913); 2 seen skulking June 1952; 6 seen early April 1954. In Coll a few were seen in summer during 1937-39, but none have been reported in 3 lists, April to June, 1954-55. Winters in small numbers, 1 or 2 being seen in Tiree on 4 occasions, December to February, 1948-55.

**COOT** (*Fulica atra*).—Present all year. Bred abundantly in Tiree (1898); common (1913); 4 adults and 7 young seen June 1949; 3 seen 28th May 1952; seen July 1952, at same site; 9 seen early April 1954; at least 2 pairs

seen July 1955. Bred in Coll before 1899; 3 pairs present 1937-39; bred 1945-49; 1 seen late April 1955; and 2 in June 1955. Present usually singly or up to 3 birds together, October to March, 1954-56, in Tiree.

**OYSTERCATCHER** (*Haematopus ostralegus*).—Present all year. Bred in Tiree and Coll before 1899. In Tiree it nested all round the coast (1913); very common, breeding on coast, *machair* and moor in June 1949 and 1952, May 1954, June and July 1955. In Coll the species was plentiful May and June 1937-38; present there July and August 1939; bred 1945-49; several pairs seen mid-May 1954; widespread on coasts and inland late April 1955; about 20 seen early June 1955. Bred in Gunna in 1949 and 1954. It was resident in Tiree (1898); resident there (1913), but more numerous in winter; Baxter and Rintoul (1953) say "almost entirely summer visitors to the Western and Northern Isles"; common on shore, 20 seen together, early April 1954; small flocks, usually not more than 8 birds together, seen in Tiree, October to March, 1953-56, increasing rapidly in numbers March to May. Seen on shore and *machair* in winter, but not usually on moorland.

**LAPWING** (*Vanellus vanellus*).—Present all year. Bred in Tiree in 1794 and 1843; bred abundantly there 1889; numerous breeding species (1898); scarce, only one tenth of usual strength, 1908; abundant, but scarcer in recent years (1913); abundant or numerous, May to July, 1949-52; becoming more common 1954; abundant, May to July, 1954-55. Bred in Coll in 1843 and 1899; plentiful there 1937-38; very common summer 1939; bred 1945-49; numerous mid-May 1954; common, breeding on grassland, late April 1955; abundant on *machair* June 1955. Bred in Gunna 1954. In Tiree (1898) few remained in winter; "the bulk of them are gone by October" (1913); plentiful December 1953; flocks of usually less than 100 birds in mild weather, September to March, 1954-56. Sizable flocks in December 1954 were reduced to a few single birds on the shore by severe frost January and February 1955.

**RINGED PLOVER** (*Charadrius hiaticula*).—Present all year. Bred in both islands before 1892. In Tiree it was numerous and bred (1898); bred abundantly (1913); bred plentifully on shore and *machair* 1949-55. In Coll, 10 to 15 pairs were estimated 1937; fair numbers there July 1939; bred 1945-49; bred 1954; a few seen on shore, but none inland, late April 1955; only 1 seen in 2 days' observation June 1955. Numerous, September to April, 1954-56, especially on passage. An albino was seen in Tiree in September 1946 (J.G.).

**GREY PLOVER** (*Charadrius squatarola*).—Autumn to spring. An uncommon migrant seen regularly before 1898; mostly single birds on the shore, but not inland, 1913; but a flock of 17 were seen that year in Tiree on 22nd September. Only recent records are of 2 and odd birds, January and February 1949-54, in Tiree (I.W.). No record from Coll.

**GOLDEN PLOVER** (*Charadrius apricarius*).—August to May. Bred in Tiree 1865, and in Coll 1899. In Coll 2 of the southern form *Ch. a. apricarius* were seen in July and August 1939, but there is no more recent evidence of breeding in either island. Numerous, autumn to spring (1899); only entirely absent in June and July (1913), but "enormous crowds" in October and from March to May; in the period 1929-55 a small trickle of migrants usually passed August to late October, when very large flocks arrived, numbers then falling till February, when only a few remained, and rising again March and April, with a few still passing in May. At peak passage during 1953-56, flocks seldom exceeded 350 birds. Annual and monthly fluctuations, 1929-55, are described in detail elsewhere (Boyd, 1956). The majority of the birds seen in spring resembled the northern type *Ch. a. altifrons*. Usually seen on grasslands, but a few also on the shore in hard frost.

**TURNSTONE** (*Arenaria interpres*).—Present all year. No breeding record. Some remained in summer in Tiree (1898); a good many remained there in summer in full breeding plumage (1913); 20 birds seen June 1949; several seen late May 1952; 6 seen July 1952; about 12 present mid-May 1954; a

few present June and July 1955. In Coll 2 or 3 were seen July 1939; 1 and 10 in late April 1955. A few were seen in Gunna 10th May 1954. Abundant, autumn to spring (1898); common in small flocks autumn and winter (1913); abundant September to April, 1953-56, flocks not usually exceeding 70 birds. Passage reported at Skerryvore 13th August 1898; a regular winter resident there 1903-06. Frequents both meadows and shore in Tiree. Systematically searches cow-pats for earthworms and beetles.

**SNIFE** (*Capella gallinago*).—Present all year. Bred in both islands before 1843; bred plentifully in Tiree (1898 and 1913); numerous there, May to July, 1949-55, eggs and young seen. In Coll, common 1937-39, and nest seen 1939; bred 1945-49; common May 1954; thought to breed all over Coll, late April 1955; 3 seen 3rd June 1955. Abundant on passage autumn to spring since before 1892; 641 shot by 7 guns in 1 day in November 1890; 249 shot by 2 guns on 29th October 1906; 1,293 shot by 2 guns in 11 days in November 1908; 151 and 118 shot by 1 gun in two consecutive days in November 1914; a total of 37,247 Common Snipe are recorded as shot in the period 1929-55 (excluding erratic shooting during 1939-45 war), an average of 1,552 per annum. In the period 1929-55 passage occurred from late August, built up to peak in late October and early November, declined thereafter till the return passage in March and April. Annual and monthly fluctuations, 1929-55, are described in detail elsewhere (Boyd, 1956). A specimen of "Sabine's Snipe"—classified by Harvie-Brown and Buckley (1892) under the species Great Snipe (*Gallinago major* Gm.)—was obtained from Tiree in January 1887; a white snipe, January 1919. No information for autumn-spring is available from Coll.

**JACK SNIFE** (*Lymnocyptes minimus*).—September to April. No breeding or summer record. Common in Tiree (1892), the average percentage of Jacks in the total snipe bag being 25%; regular, autumn and winter (1898); arrived late September, number usually erratic, percentage of the total snipe bag 10-12% (1913); "scarcer in recent years" (1913); a total of 2,355 were shot in the period 1929-55 (excluding erratic shooting during 1939-45 war), an average of 98 per annum, comprising 5.2% of the total snipe bag; peak passage late October-early November during 1929-55. Annual and monthly fluctuations, 1929-55, are described elsewhere in detail (Boyd, 1956). Seen in Tiree early April 1954, in Coll late April 1955, and at Skerryvore 22nd October 1898.

**WOODCOCK** (*Scolopax rusticola*).—October to February. No breeding record. Abundant on passage in Tiree before 1892; regular winter visitor (1898); passage late October and early November, a few appearing February, and movement from the mainland in hard frost (1913); though Baxter and Rintoul (1953) say that it is abundant on passage, only 388 are recorded as shot in Tiree 1929-54. An extraordinary rush appears to have taken place in January 1939, 164 birds being shot in a fortnight. None has been reported by spring observers, and no recent record is available from Coll. At Skerryvore, 2 seen 5th November 1897, and many 20th November 1898.

**CURLEW** (*Numenius arquata*).—Present all year. Bred in Coll before 1899; a few pairs seen there June 1929; 8 pairs seen, believed breeding, June 1938; large flocks late July 1939; bred 1945-49; several seen mid-May 1954; odd birds on shore, fighting inland at dusk, late April 1955; less than 10 seen 2nd-3rd June 1955. Bred in Tiree in 1953 (J.G.), but no other positive breeding record for that island. Did not breed in Tiree (1892); not present in summer (1898); Anderson (1913) says it is absent May to July, but in June 1912 a small flock was reported (N.H.); 1 and 2 seen June 1947; small parties of up to 20 birds June 1949; several on shore 28th May 1952, and also on heath in July; small flocks 7th-10th May 1954; a pair seen in west Tiree, 18th June 1955; a flock of about 100 there early July 1955, and the species was common all over Tiree in late July. Single bird seen in Gunna, 10th May 1954. On passage at Skerryvore 7th-24th August 1897. Numerous in winter since before 1892, flocks September to April, 1953-56, usually less than 100 strong.

**WHIMBREL** (*Numenius phaeopus*).—April to June; August and September. No breeding record. Heard several times in Coll in early August 1939

(A.G.S.B.), and at the Sound of Gunna in August 1945 (M.H.). A pair was seen in Tiree June 1949, and a single bird on five days at same site there June 1952. In Tiree the species passed in large flocks in May before 1898, with comparatively few in autumn; passed late April to late May, and a few scattered birds from late August to mid-September, before 1913; seen in Coll and Tiree, April and May, 1954-55, only in small flocks. Seen at Skerryvore in August 1903-06, and reported as a winter straggler to Tiree, January 1901-02, and December 1953.

**BLACK-TAILED GODWIT** (*Limosa limosa*).—Spring and autumn. Seen rarely in spring in Tiree (1898); seen both spring and autumn, "in late years more frequently in autumn", never more than 3 together (1913); 1 pair seen mid-April 1955; 3 seen 19th-22nd May 1956. No record from Coll.

**BAR-TAILED GODWIT** (*Limosa lapponica*).—September to April. Only summer record is of a pair reported by Anderson (Baxter and Rintoul, 1953). Seen in Tiree, 29th August 1897; common autumn, winter and spring (1898 and 1913); fairly common, September and April, 1954-56, flocks not usually exceeding 12 birds; small numbers, October to March, 1951-56, flocks not usually exceeding 8 birds.

**WOOD SANDPIPER** (*Tringa glareola*).—One seen at Vault, Tiree, June 1950 (J.T.D.W.).

**COMMON SANDPIPER** (*Tringa hypoleucos*).—May to September. Bred in Tiree before 1871, and in Coll before 1899. Present in Tiree 1912; bred sparingly there 1913; 1 pair bred at Vault 1947; odd birds on shore and 2-5 pairs at fresh waters in June 1952; 1 pair at fresh waters July 1952; birds, some paired, were reported from 5 different sites in Tiree in June and July 1955. Thought to breed more plentifully in Coll than Tiree. A pair seen at fresh waters mid-May 1954, in Coll, and "tens" seen 3rd June 1955. At Skerryvore, 2 seen August 1906. Have been reported as late as 13th September 1897, but no winter records.

**REDSHANK** (*Tringa totanus*).—Present all year. Bred in Coll before 1899, but first recorded breeding in Tiree in 1945 (N.McI.). In Tiree it was present in summer 1912, 1913, 1942; bred 1945; 2 heard and one seen June 1952; 1 seen July 1952; at least 3 breeding pairs June and July 1955. Present in Coll in June 1929, July 1939, August 1945, June 1946 and 1949; none seen 11th-14th May 1954, nor 2nd-3rd June 1955. Plentiful September to April since before 1892; flocks small but numerous on the shore, usually not more than 20 birds in each, and 1-6 seen frequently on the grassland, winter 1952-56.

**GREENSHANK** (*Tringa nebularia*).—Present all year. Bred in Tiree 1891, but no breeding record from Coll. Seen in Tiree, August 1897-98, June 1912, August 1954; birds seen at 3 different sites there in June and July 1955, one pair regularly. Known on passage in Tiree since 1887; common autumn to spring (1898); sparsely distributed, usually singly or paired, autumn to spring (1913); 2-4 on 4 occasions, January and February, 1949-54; odd birds seen 10th-11th April 1954, 25th February 1955. In Coll, 5 or 6 seen on passage in August 1939. Seen both on the shore and at fresh waters.

**KNOT** (*Calidris canutus*).—August to April. One shot in Tiree September 1887; seen in small parties late August, and larger parties late September, with a few occurring in spring (1889 and 1913); 1-11 seen January and February 1954; seen in mixed wader flocks August and September 1954-55; 80-110 seen in Tiree early April 1954. No record from Coll.

**PURPLE SANDPIPER** (*Calidris maritima*).—October to April. Plentiful in Tiree, November to April, since before 1892. Flocks, usually less than 30 strong, common on shore October-April 1954-55. A regular winter resident at Skerryvore 1903-06.

**LITTLE STINT** (*Calidris minuta*).—Autumn. Reported on passage in Tiree since 1892; as many as 20 seen together (1898); seen on passage, but not



every year (1913); small party seen 10th September 1954. Not reported from Coll before 1899, but many reported there late February 1902. No recent report from Coll.

**DUNLIN** (*Calidris alpina*).—Present all year. Bred in Tiree in "hundreds" before 1898; common breeder (1913); a few bred 1950; common, breeding on grasslands and moor, 1952-55. In Coll a few were breeding before 1899; a pair was thought to nest there 1937-38; common in summer 1945-49; present mid-May 1954; 15 seen 22nd April 1955. None seen in Coll in 2 days' observation in June 1955, and probably less common there than in Tiree where in 2 days' observation in the same month it was reported as numerous. Breeding birds are of the sub-species *C. a. schinzii*. More common in summer in Tiree than in winter (1898 and 1913). Common both summer and winter 1952-55, with flocks of usually not more than 30 in mid-winter. Seen feeding on *machair*. Many of the wintering birds are of the larger sub-species *C. a. alpina*.

**CURLEW SANDPIPER** (*Calidris testacea*).—Seen Tiree on 23rd September 1898.

**SANDERLING** (*Crocethia alba*).—Present all year. No breeding record. One shot in Tiree in June 1891; frequent autumn to spring (1898); abundant, only absent in breeding season (1913); 42 seen 21st July 1942; seen on passage, flocks varying in size 2-29 on two strands, 27th May-6th June 1952; seen August 1954. In Coll, 9 were seen on 12th June 1902 and 17 on 15th June 1938; 3 seen late July 1939; odd birds present late April 1955. Common on passage in Tiree since before 1898, and plentiful spring and autumn 1952-55 in flocks not usually exceeding 200 birds. Common in winter, in mixed wader flocks on strands, 1954-56.

**RUFF** (*Philomachus pugnax*).—Occasional single birds in Tiree in autumn, (1898 and 1913); 1 seen August 1918; 3 males and 2 females 11th September 1956 (J.M.B., W.I.B.). In Coll, 1 seen on 16th September 1905.

**GREY PHALAROPE** (*Phalaropus fulicarius*).—One shot in Tiree, September 1886, and another seen on the sea, November 1890. No other record.

**RED-NECKED PHALAROPE** (*Phalaropus lobatus*).—Summer. First bred in Tiree in 1902; a few pairs bred regularly (1913); Tiree quoted as a breeding-station by Fisher (1947) and Witherby *et al.* (1938); a few pairs have bred in recent years.

**ARCTIC SKUA** (*Stercorarius parasiticus*).—May to August. Bred in Coll before 1898; 2 colonies there, with about 5 pairs in each, 1937-38; about 15 pairs with young in August 1939; 12 pairs August 1945; 4 pairs June 1949; 30-40 present in early June 1955 (A.A.K.W.); recent increase, 1956 (W.P.C.-F.). A pair bred in Tiree in 1891, and it has been seen there in summer without a breeding record (1898), 1912, 1913, on moor 1948, 1952, 1954, 1955. Sometimes seen in winter off Tiree.

**GREAT SKUA** (*Stercorarius skua*).—Reported off Tiree mid-January 1902, mid-April 1937, August 1951, July 1952. No sign of breeding.

**GREAT BLACK-BACKED GULL** (*Larus marinus*).—Present all year. Not thought to breed in Tiree (1898); not breeding in Tiree, but breeding proved in Gunna (1913); 1 nest on an off-shore islet, and 2 nests in Gunna, June 1949; odd birds, and present in mixed gull flock, June 1952; 1 pair seen on off-shore islet July 1952; a nest has been found in recent years at Ceann a' Mhara (N.McI.); present in Gunna 10th May 1954, but no nest found; present in mixed gull flocks June and July 1954-55. In Coll, bred in fair numbers 1939 (A.G.S.B.); frequently seen summer 1945-46, and 1949; present May 1954; present, scattered all over, late April 1955; less than 10 seen June 1955. Present in Tiree from September to March, both on shore and inland, but usually no more than 4 seen together.

**LESSER BLACK-BACKED GULL** (*Larus fuscus*).—April to October. Bred in both islands before 1899; bred sparingly in Tiree (1913); nesting Ceann a' Mhara,

and a slightly smaller colony in Gunna, June 1949; several pairs among Herring Gulls, Ceann a' Mhara, July 1952; present in Gunna, but no eggs seen, May 1954; several pairs seen, but no eggs or young, June 1955. Present in mixed gull flocks on *machair* and strands in Tìree July 1952 and 1955. Bred in Coll, Gunna and Soa, 1937-39; during 1945-49 a colony present south of Arinagour (about 30 birds, including 13 young, August 1945); several hundred gulls, including some of this species, in flight over the Eilein Mor rocks while native egg-collectors were ashore, and present also south of Arinagour, mid-May 1954; scarce in late April 1955; breeding colony of several hundred pairs on level moor north of Arinagour in June 1955. Anderson (1898 and 1913) said this species was "resident", but no winter record is available, and doubt is cast on this statement (Editors, *Scot. Nat.*, 1913).

**HERRING GULL** (*Larus argentatus*).—Present all year. Bred in Tìree and Coll before 1899. Nesting Ceann a' Mhara 1912, 1913; "Order 3" colony (100-1,000 pairs), with a large number of young, July 1942; breeding Ceann a' Mhara and Gunna 1949 and mid-May 1954; breeding in fair numbers 1952; 100-150 nests (including Lesser Black-backed Gull) at Ceann a' Mhara in June 1955. Bred in Coll 1937-39, 1945-49; colony of several hundred birds (see Lesser Black-backed Gull) over Eilein Mor rocks mid-May 1954; commonest gull on Coll late April 1955; 10-100 seen 2nd-3rd June 1955. Predominant in mixed gull flocks in Tìree in July 1952 and 1955. Present (always more than 6) all year at Skerryvore, 1906. Common, September-April.

**COMMON GULL** (*Larus canus*).—Present all year. Bred in Tìree before 1892, and summer observers in 1898, 1912, 1913, 1949, 1952, 1954-55 all report it as a common breeder both on the upper shore and inland. Bred in Coll before 1899 and during 1937-39; a colony south of Loch an Duin with 16 nests June 1946, and 8 nests June 1949; present mid-May 1954; surprisingly few seen, only 1 or 2 parties of 20-30 birds on cultivated ground, late April 1955; none seen 2nd-3rd June 1955. None seen in Gunna June 1949, but present on shore rocks 10th May 1954. Flocks at fresh water lochs March and April, and again on *machair* and shore July and August. Common on shore September to February, usually less than 10 birds together.

**GLAUCOUS GULL** (*Larus hyperboreus*).—Winter. Single birds seen regularly in winter about 1913 and at Skerryvore, where 1 was seen as late as 3rd April 1904, and where birds were also seen January and February 1889, and March 1897. Seen in Tìree mid-winter 1949-50.

**ICELAND GULL** (*Larus glaucoides*).—1 seen mid-winter 1949-50 (J.T.D.W.).

**LITTLE GULL** (*Larus minutus*).—Seen at Skerryvore 24th September 1903.

**BLACK-HEADED GULL** (*Larus ridibundus*).—Present all year. First breeding record from Tìree was of 1 pair in 1889; another pair 1891; a few pairs 1898; increased, breeding at several places, by 1913; many seen, but only 1 nest, June 1949; 1 or 2 small breeding colonies June 1952; colony of about 12 pairs sharing islet in Loch Bhasapol with Common Terns in June and July 1952; 3 sites, with usually less than 30 pairs at each, June and July 1954-55. Bred in Coll occasionally before 1899; 2 colonies of 6 and 7 pairs in 1937-38; young seen 1939; not noted breeding since, but present in small numbers April to June 1954-55. Common in winter, not usually more than 10 birds together.

**SABINE'S GULL** (*Xema sabini*).—Seen at Skerryvore in January 1905 and November 1907.

**KITTIWAKE** (*Rissa tridactyla*).—Present all year. Bred in Tìree at Ceann a' Mhara before 1891, when about 300 pairs nested; bred there (1898 and 1913); 258 pairs present July 1942 (J.F.); 200 pairs nesting, but about 300 pairs present, June 1949 (W.C.T.); 425 birds present June 1952 (H.A.C.); 438 birds counted July 1955 (J.M.B.). No breeding record from Coll. Present all year at Skerryvore; most numerous August 1903-06.

(To be concluded)

# BRITISH RECOVERIES OF BIRDS RINGED ABROAD

Communicated by E. P. LEACH

[This list continues from that published in 1956 (*antea*, vol. xlix, pp. 438-452). Among records of special interest included in it are a number relating to wildfowl, which help to show the relation of breeding areas to winter quarters. Camargue-ringed Mallard and Scaup have begun to be noted here, previous recoveries having mostly been on a line running from S.W. to N.E. through the Camargue. It is still not clear whether any birds native to the British Isles are concerned. One Russian-ringed Mallard was aged 7-plus years, and a Scaup from Iceland apparently 8-plus.

A Goosander from Finland in Norfolk, two Pink-footed Geese from N.E. Greenland in Northumberland, two Brent Geese from Spitzbergen in Northumberland, two Barnacles from the same area on the Solway, five Barnacles from N.E. Greenland in the northern Outer Hebrides and another in northern Ireland suggest some probable links between summer and winter quarters.

Swedish Ospreys on passage through Scotland, a Moorhen and a Coot from across the North Sea, a Woodcock from Finland in Kent, widespread occurrences here of Knot and Dunlin ringed in Scandinavia, Great Black-backed Gulls wintering from Iceland and Norway, Herring Gulls from Norway and an Iceland Gull from Greenland are also interesting. Some of the Knots and a Dunlin are aged between 5 and 7-plus years; and these together with a Snipe from Iceland aged 7½ and a Curlew from Finland aged 18½ show how long-lived waders can be in Europe.

There is evidence of Common Terns from Finland and the Low Countries passing through the English Channel on migration, and a sad and curious record of an Arctic Tern from Scotland behaving suicidally on passage inland through Wiltshire.

A first-winter Stock Dove from Finland, shot in Norfolk, is of special interest in view of the obscurities of pigeon migration. A Swedish Long-eared Owl in Yorkshire had been ringed 3½ years earlier. Recoveries of Heligoland-ringed Blackbirds at Spurn and Dungeness, of an Iceland Wheatear at Bardsey and of an Iceland White Wagtail at Lundy illustrate the good work of the Bird Observatories as centres for recovery as well as for marking.—EDS.]

## Key to Symbols and Terms

- O : Indicates bird breeding, or bred, at place of ringing.
- Age : pull. (pullus)—nestling or chick, not yet flying ;  
juv.—young, able to fly freely (but in some cases this may mean a nestling or chick, owing to lack of unanimity in the various Ringing Schemes) ;  
\* —full-grown (age uncertain), trapped ;  
ad. —adult.
- Sex : ♂—male ; ♀—female.
- v : Caught or trapped and released with ring.
- + : Shot or killed by man.
- × : Found dead or dying.
- ( ) : Caught or trapped alive and not released, or released but with ring removed.
- ?/ : Manner of recovery unknown.

NOTE : The format of the report, and the symbols and terms employed are those put forward for international adoption at the XIth International Ornithological Congress. In the list the ringing details are given on the first or first and second lines and the recovery data on a new line below.

*Abbreviations used for Ringing Stations*

<i>B.</i>	Brussels	<i>O.</i>	Oslo
<i>C.</i>	Copenhagen	<i>P.</i>	Paris
<i>G.</i>	Gothenburg	<i>Pe.</i>	Prague
<i>H.</i>	Heligoland	<i>P-V.</i>	Polonia Varsovia (Warsaw)
<i>Hki.</i>	Helsinki	<i>Rk.</i>	Reykjavik
<i>Hki.R.S.</i>	Helsinki Riista Säätiö (Game Research Institute)	<i>Stav.</i>	Stavanger
<i>L.</i>	Leiden	<i>St.</i>	Stockholm
<i>La.</i>	Lithuania	<i>St. Orn.</i>	Stockholm "Ornis" (Sveriges Ornitologiska Förening)
<i>M.</i>	Moscow	<i>S.J.F.</i>	Svenska Jägare Förbundet

**Heron** (*Ardea cinerea*)

<i>Stav.</i>	O	pull.	11.5.52	Stangvik : 62° 53' N. 8° 32' E. (Nordmøre) <b>Norway</b>
23704	×		0.4.55	River Don : 57° 15' N. 2° 40' W. (Aberdeenshire)
<i>Stav.</i>	O	pull.	1.6.52	as above ( <b>Norway</b> )
23727	×		19.1.55	Macduff : 57° 40' N. 2° 30' W. (Banffshire)
<i>Stav.</i>	O	pull.	25.5.53	Sund : 60° 17' N. 5° 10' E. (Hordaland) <b>Norway</b>
23509	×		18.12.54	Belfast Lough (Northern Ireland)
<i>Stav.</i>	O	pull.	7.6.54	as above ( <b>Norway</b> )
23593	×		30.3.55	Benmore, Dunoon : 56° 02' N. 5° 00' W. (Argyll)
<i>O.</i>	O	pull.	7.6.52	Egersund : 58° 28' N. 6° 00' E. (Rogaland) <b>Norway</b>
026394	×		26.4.53	Galashiels : 55° 37' N. 2° 49' W. (Selkirk)
<i>O.</i>	O	pull.	10.6.53	as above ( <b>Norway</b> )
024807	×		ca.13.10.53	Isle of Lewis (Outer Hebrides)
<i>O.</i>	O	pull.	10.6.53	as above ( <b>Norway</b> )
024801	×		ca.30.3.54	Newtonhill : 57° 02' N. 2° 08' W. (Kincardine)
<i>O.</i>	O	pull.	10.6.53	as above ( <b>Norway</b> )
026387	×		0.2.54	Carlisle : 54° 53' N. 2° 56' W. (Cumberland)
<i>O.</i>	O	pull.	6.6.54	as above ( <b>Norway</b> )
026521	v		7.12.54	Isle of Barra (Outer Hebrides)
<i>O.</i>	O	pull.	11.6.54	as above ( <b>Norway</b> )
024777	×		1.12.56	Meavaig : 57° 52' N. 6° 49' W. Isle of Harris (Outer Hebrides)
<i>St.</i>	O	pull.	21.5.56	Forshälla : 58° 16' N. 11° 56' E. (Bohus) <b>Sweden</b>
S12871	×		27.10.56	Plaxtol : 51° 16' N. 0° 19' E. (Kent)
<i>G.</i>	O	pull.	31.5.54	Hålta : 57° 52' N. 11° 45' E. (Bohus) <b>Sweden</b>
E7153	×		2.2.55	Burley : 50° 49' N. 1° 42' W. (Hampshire)

**Mallard** (*Anas platyrhynchos*)

<i>M.</i>	?		20.7.47	Novgorod : 58° 32' N. 31° 18' E. <b>Russia</b>
D2.4496	+		ca.10.1.55	Wigtown : 54° 52' N. 4° 27' W.
<i>Hki.</i>	O	juv.	19.7.53	Närpes : 62° 20' N. 21° 20' E. <b>Finland</b>
H16883	+		0.3.54	Southwell : 53° 04' N. 0° 52' W. (Nottinghamshire)
<i>Hki.</i>	O	juv.	23.7.55	Pori : 61° 30' N. 21° 45' E. <b>Finland</b>
H.18684	+		0.1.56	Happisburgh : 52° 50' N. 1° 33' E. (Norfolk)
<i>Hki. R.S.</i>	O	juv.	26.7.56	Tervola : 66° 05' N. 24° 50' E. <b>Finland</b>
6253	+		24.12.56	Rosebery Reservoir : 55° 48' N. 3° 07' W. (Midlothian)
<i>S.J.F.</i>	O	pull.	24.6.53	Överluleå : 65° 49' N. 21° 32' E. <b>Sweden</b>
7652	×		12.4.55	Leswalt : 54° 55' N. 5° 06' W. (Wigtown)
<i>Stav.</i>	O	pull.	6.7.55	Varhaug : 58° 38' N. 5° 38' E. (Rogaland) <b>Norway</b>
412037	+		22.12.55	Pocklington : 53° 56' N. 0° 46' W. (Yorkshire)

juv.	O	juv.	2.7.52	Stokke : 59° 11'N. 10° 19'E. (Vestfold) <b>Norway</b>
5301	+		15.1.53	Felton : 55° 18'N. 1° 40'W. (Northumberland)
	ad.	♂	20.12.54	Le Sambuc : 43° 31'N. 4° 42'E. (B. d. Rh.) <b>France</b>
A.2048	+	Oct. or Nov. 55		Humber : ca.53° 39'N. 0° 06'E. (Yorkshire)
	ad.	♀	17.8.54	Meetkerke : 51° 14'N. 3° 09'E. (West Flanders)
9515				<b>Belgium</b>
	( )		15.5.55	Needham Market : 52° 09'N. 1° 03'E. (Suffolk)

This last bird was caught while incubating a clutch of eggs in Suffolk and provides an unusual recovery for a Mallard.

The Mallard ringed in the Camargue is noteworthy and there are also Teal from this comparatively new Station in the south of France. A great many Mallard, as usual, have been ringed in decoys in Holland and Belgium and recovered in the British Isles in widely-spread areas.

**Teal (*Anas crecca*)**

juv.	O	pull.	20.8.49	Arnanes : 66° 08'N. 16° 44'W. <b>Iceland</b>
3348	+		23.12.55	Lough Swilly : 55° 10'N. 7° 32'W. (Donegal)
	O	♀	3.6.54	Skipalón : 65° 47'N. 18° 12'W. <b>Iceland</b>
5512	+		3.10.55	River Thurso : 58° 35'N. 3° 31'W. (Caithness)
	O	pull.	12.7.53	Fnjóskadalur : 65° 46'N. 17° 53'W. <b>Iceland</b>
3331	+		6.10.56	Alloa : 56° 07'N. 3° 50'W. (Clackmannan)
	O	pull.	12.7.53	as above ( <b>Iceland</b> )
3335	+	♀	25.12.56	Kilkenny : 52° 39'N. 7° 15'W.
	O	pull.	25.7.54	as above ( <b>Iceland</b> )
8302	×		0.1.55	Balvicar Bay : 56° 18'N. 5° 36'W. (Argyll)
	O	pull.	25.7.54	as above ( <b>Iceland</b> )
8324	+		19.12.55	Cong : 53° 32'N. 9° 17'W. (Mayo)
	ad.	(moult)	4.8.53	Myvatn : 65° 39'N. 16° 58'W. <b>Iceland</b>
7739	+		26.9.56	Armagh : 54° 21'N. 6° 39'W.
	O	pull.	10.7.56	Oulujoki : 64° 58'N. 25° 27'E. <b>Finland</b>
11511	+		24.11.56	Sedgemoor : 51° 06'N. 2° 52'W. (Somerset)
	ad.	♂	15.10.55	Amager : 55° 40'N. 12° 38'E. <b>Denmark</b>
00275	+		22.1.56	Willington : 52° 51'N. 1° 34'W. (Derbyshire)
	juv.	♂	19.10.55	as above ( <b>Denmark</b> )
00285	v		16.11.55	} Abberton : 51° 50'N. 0° 53'E. (Essex)
			9.11.56	
	juv.	♂	21.11.55	Le Sambuc : 43° 31'N. 4° 42'E. (B. d. Rh.) <b>France</b>
A.17856	+		18.2.56	Poole Harbour : 50° 43'N. 2° 05'W. (Dorset)
	ad.	♂	20.1.56	as above ( <b>France</b> )
33124	+		3.12.56	Cattistock : 50° 48'N. 2° 35'W. (Dorset)
	ad.	♂	25.2.56	as above ( <b>France</b> )
33255	×		15.4.56	Hallbankgate : 54° 56'N. 2° 40'W. (Cumberland)

Note the dates of ringing and recovery of the three birds from the south of France. Teal have been recovered in large numbers from decoys in Belgium and Holland, but the above selection has been made as giving countries of origin and other items of special interest.

**Garganey (*Anas querquedula*)**

juv.	31.8.53	Bruekelen-St.-Pieters : 52° 11'N. 5° 07'E. (Utrecht) <b>Holland</b>	
6313	+	20.12.55	Corringham : 51° 31'N. 0° 30'E. (Essex)
	*	29.3.55	Meetkerke : 51° 14'N. 3° 09'E. (West Flanders) <b>Belgium</b>
3139	+	0.11.56	Abberton : 51° 50'N. 0° 53'E. (Essex)

**Gadwall** (*Anas strepera*)

<i>Rk.</i>	O	♀	15.6.54	Myvatn : 65° 39'N. 16° 58'W. <b>Iceland</b>
43140	+		o.1.55	Ennis : 52° 51'N. 8° 59'W. (Clare)

**Wigeon** (*Anas penelope*)

<i>Rk.</i>	O	pull.	16.8.53	Fnjóskadalur : 65° 46'N. 17° 53'W. <b>Iceland</b>
44741	+		7.1.55	Roseheartly : 57° 42'N. 2° 07'W. (Aberdeenshire)
<i>Rk.</i>	O	pull.	25.7.54	as above ( <b>Iceland</b> )
44745	+		22.1.55	Dromod : 53° 51'N. 7° 55'W. (Leitrim)
<i>Rk.</i>	O	pull.	28.7.54	as above ( <b>Iceland</b> )
44748	+		12.2.56	River Shannon : 53° 22'N. 7° 55'W. (Roscommon)
<i>Rk.</i>	O	pull.	3.8.56	as above ( <b>Iceland</b> )
45443	+		10.11.56	Carnforth : 54° 09'N. 2° 44'W. (Lancashire)
<i>Rk.</i>	O	pull.	30.8.54	Arnanes : 66° 08'N. 16° 44'W. ( <b>Iceland</b> )
44220	+		0.12.55	Lough Swilly : ca.55° 10'N. 7° 32'W. (Donegal)
<i>C.</i>		♂	7.10.51	Amager : 55° 40'N. 12° 38'E. <b>Denmark</b>
496288	+		16.12.52	Welney : 52° 31'N. 0° 15'E. (Norfolk)
<i>L.</i>		♂	5.12.52	Texel : 53° 05'N. 4° 50'E. <b>Holland</b>
271348	+		18.1.55	Birr : 53° 06'N. 7° 54'W. (Offaly)
<i>L.</i>		juv.	3.12.53	as above ( <b>Holland</b> )
280472	+		0.1.56	Wells : 52° 58'N. 0° 52'E. (Norfolk)
<i>L.</i>		♀	14.10.54	as above ( <b>Holland</b> )
277029	+		25.1.55	Wadebridge : 50° 34'N. 4° 50'W. (Cornwall)
<i>L.</i>		juv.	2.11.54	as above ( <b>Holland</b> )
277047	+		7.2.56	River Stour : ca.51° 58'N. 1° 10'E. (Essex)
<i>L.</i>		♀	6.12.55	as above ( <b>Holland</b> )
348375	+		19.2.56	Medway Estuary : 51° 25'N. 0° 37'E. (Kent)
<i>L.</i>		*	25.11.53	Giethoorn : 52° 45'N. 6° 05'E. (Overijssel) <b>Holland</b>
253336	+		14.1.55	Tewkesbury : 51° 59'N. 2° 09'W. (Gloucestershire)
<i>L.</i>		♂	23.7.54	Zwarte Meer : 52° 38'N. 6° 00'E. (Overijssel) <b>Holland</b>
279324	+		3.1.56	Dyke : 57° 37'N. 3° 42'W. (Moray)

**Pintail** (*Anas acuta*)

<i>Rk.</i>	O	pull.	7.7.56	Laxárdalur : 65° 46'N. 17° 16'W. <b>Iceland</b>
44804	+		0.10.56	Stronsay : 59° 07'N. 2° 40'W. (Orkney)
<i>L.</i>		*	13.8.55	Engwierum : 53° 20'N. 6° 09'E. (Friesland) <b>Holland</b>
283101	+		20.2.56	Farlington : 50° 50'N. 1° 03'W. (Hampshire)
<i>L.</i>		♂	19.10.50	't Zand : 52° 51'N. 4° 46'E. (Noord <b>Holland</b> )
245555	+		22.1.55	North Wootton : 52° 47'N. 0° 26'E. (Norfolk)
<i>L.</i>		♂	8.8.51	Zwarte Meer : 52° 38'N. 6° 00'E. (Overijssel) <b>Holland</b>
244811	+		4.1.55	Wexford : ca.52° 20'N. 6° 28'W.

**Shoveler** (*Spatula clypeata*)

<i>L.</i>		juv.	19.8.55	Oudesluis : 52° 50'N. 4° 49'E. (Noord <b>Holland</b> )
277059	+		25.1.56	Belfast : 54° 35'N. 5° 56'W. (Antrim)
<i>L.</i>		juv.	2.8.55	Schouwen-Duiveland : 51° 38'N. 4° 03'E. (Zeeland) <b>Holland</b>
257764	+		1.9.55	Isle of Sheppey : 51° 24'N. 0° 46'E. (Kent)
<i>P.</i>		♂	17.4.56	Rue : 50° 16'N. 1° 40'E. (Somme) <b>France</b>
EA4303	+		3.9.56	Holme : 52° 58'N. 0° 33'E. (Norfolk)

**Scaup** (*Aythya marila*)

<i>Rk.</i>	O	♀	13.7.47	Myvatn : 65° 39'N. 16° 58'W. <b>Iceland</b>
3/1739	v		13.7.48	<i>ibid.</i>
	( )		1.3.55	Stromness : 58° 58'N. 3° 18'W. (Orkney)

	O	pull.	17.7.49	as above ( <b>Iceland</b> )
0568	+		1.1.55	Killorglin : 52° 07'N. 9° 47'W. (Kerry)

**Tufted Duck** (*Aythya fuligula*)

	O	pull.	29.6.56	Myvatn : 65° 39'N. 16° 58'W. <b>Iceland</b>
0522	+		30.12.56	Lough Ennell : 53° 28'N. 7° 24'W. (Westmeath)
	*		18.12.54	Lekkerkerk : 51° 54'N. 4° 39'E. ( <b>Zuid Holland</b> )
5566	×		4.2.56	Chingford : 51° 39'N. 0° 01'W. (Essex)

**Pochard** (*Aythya ferina*)

	♂		6.1.56	Lekkerkerk : 51° 54'N. 4° 39'E. ( <b>Zuid Holland</b> )
8331	v		27.2.56	Tilbury : 51° 28'N. 0° 22'E. (Essex)
	+		0.3.56	Cliffe Marshes : 51° 28'N. 0° 28'E. (Kent)
	♀		29.1.56	as above ( <b>Holland</b> )
8372	+		31.1.56	Abberton : 51° 56'N. 0° 53'E. (Essex)

**Goosander** (*Mergus merganser*)

	O	♀	18.6.55	Uusikaupunki : 60° 48'N. 21° 20'E. <b>Finland</b>
177	×		0.2.56	Breydon Water : ca. 52° 37'N. 1° 42'E. (Norfolk)

This is the first Goosander from Finland and only the third recovery from abroad, the other two being Swedish birds from the province of Jämtland recorded in 1945 and 1947. Conversely, however, there are a few records of winter-visitors ringed at reservoirs in England which have later been recovered in Sweden and Finland, probably in their native localities.

**Shelduck** (*Tadorna tadorna*)

	O	pull.	27.7.52	Vig : 58° 43'N. 5° 32'E. (Rogaland) <b>Norway</b>
991	×		24.9.52	Broughty Ferry : 56° 28'N. 2° 52'W. (Angus)
	O	pull.	20.7.53	Le Zoute : 51° 20'N. 3° 17'E. (West Flanders) <b>Belgium</b>
428	+		20.2.56	St. Osyth : 51° 48'N. 1° 05'E. (Essex)
		ad.	31.8.52	Estuary of R. Weser : ca. 53° 50'N. 8° 20'E. <b>Germany</b>
8306	×		15.12.55	Merse Head : 54° 53'N. 3° 40'W. (Kirkcudbright)

This last bird was ringed during moult.

**White-fronted Goose** (*Anser albifrons*)

The recoveries of this goose, since our last list, are all of the Greenland subspecies (*A. a. flavirostris*), bearing the rings of the Copenhagen Museum, and are all from Ireland with the exception of one killed by collision with poles near Kirkwall, Orkney. The counties of Ireland where twenty geese were recovered are Wexford (11), Roscommon (3), Mayo (2), and Antrim, Fingal, Longford and Westmeath (1 each).

**Pink-footed Goose** (*Anser arvensis brachyrhynchus*)

	O	Summer 1955	Antarctic Dal : 72°N. 23°W. <b>Greenland</b>
794 } 795 }	+	8.10.55	Longforgan : 56° 27' N. 3° 06'W. (Perthshire)

These two birds ringed in north-east Greenland are the first foreign-ringed Pink-footed Goose recoveries in Britain other than ones marked in Iceland, but several have been ringed in the British Isles as winter-visitors and recovered in the breeding-area on the east coast of Greenland at latitudes between 60° and 74°N.

Many of the Pink-footed Geese ringed in central Iceland during the Wildfowl Trust expeditions of 1951 and 1953 were recovered in the British Isles in 1955 and 1956, but there is nothing to which attention need specially be drawn, as the localities were all the usual ones quoted in former years. During the period under review only one record was received from Ireland, namely from Wexford.

#### Brent Goose (*Branta bernicla*)

Stav.	O	ad.	16.7.54	Reindalen : 77° 50'N. 15° 30'E. <b>Spitzbergen</b>
409619	×		24.2.55	Alnmouth : 55° 24'N. 1° 37'W. (Northumberland)
Stav.	O	ad.	16.7.54	as above ( <b>Spitzbergen</b> )
409080	×		27.3.55	Hauxley : 55° 20'N. 1° 34'W. (Northumberland)

There is one other record of a ringed Brent Goose being recovered in Great Britain and this also was marked in Spitzbergen (with a Moscow ring, in 1933, and shot in Nigg Bay, Easter Ross, in January, 1934).

The Brents and Barnacles carrying Stavanger rings were marked during the British Cambridge-Sherborne Expedition to Spitzbergen, and the Barnacle-Goose is a species which now appears for the first time in our lists.

#### Barnacle Goose (*Branta leucopsis*)

Stav.	O	ad.	16.7.54	Reindalen : 77° 50'N. 15° 30'E. <b>Spitzbergen</b>
307015	+		0.1.55	Solway : ca.54° 55'N. 3° 35'W. (Dumfriesshire)
Stav.	O	ad.	16.7.54	as above ( <b>Spitzbergen</b> )
307023	×		1.5.55	Solway (Dumfriesshire)
C.	O	pull.	6.8.55	Flemingdalen : 71° 30'N. 23° 20'W. <b>Greenland</b>
275365	/?		ca.10.3.56	Loch Erisort : ca.58° 07'N. 6° 25'W. Isle of Lewis (Outer Hebrides)

Four other Barnacle Geese ringed at the same time were recovered (either shot or found dead) on Ensay, 57° 46'N. 7° 05'W., in the sound of Harris (Outer Hebrides) during the autumn and winter of 1955.

C.	O	pull	31.7.55	Flemingfjorden : (N.E. <b>Greenland</b> )
275428	×		26.11.55	The Skerries : 55° 14'N. 6° 37'W. Portrush (Antrim)

#### Bewick's Swan (*Cygnus columbianus bewickii*)

P.	ad.	0.2.56	Paimboeuf : 47° 17'N. 2° 02'W. (Loire Inf.) <b>France</b>
BA1252	+	0.12.56	Killeagh : 51° 56'N. 7° 59'W. (Cork)

The authorities at the Paris Museum of Natural History tell us that Bewick's Swans are exceedingly rare on the Loire, and that this is the only one ever ringed under their Scheme. We have also heard from the ringing station at Nantes, which was directly responsible for the capture of this swan, and we are told that it was found injured on an ice-floe in the Estuary of the Loire, during a spell of very hard weather in February 1956 when several parties of swans were observed.

The injured bird was cared for and after about ten days was released on le Lac de Grandlieu, 12 km. S.W. of Nantes. The party found in Co. Cork the following winter consisted of five birds, of which three others were shot besides the ringed one.





*Sigvard Rosén*

ADULT PYGMY OWL (*Glaucidium passerinum*): SWEDEN, WINTER

As its name suggests, the Pygmy is the smallest European owl, little bigger than a Bullfinch (*Pyrrhula pyrrhula*), and the huge-looking rodent which this one has just caught is only a wood mouse (*Apodemus* sp.). Voles, mice and shrews, small birds, lizards and insects form the prey of this species (see pages 72-74). This plate shows well the conspicuous white "eye-brows" which, however, seem to be a rather variable feature (*cf.* plate 16 and see page 73).



Kurt Ellstrom and Einar Sjoberg

ADULT FEMALE PYGMY OWL (*Glaucidium passerinum*): SWEDEN, 12111 JUNE 1955. The mantle, back and wings are dark brown, spotted with greyish-buff, and the brown tail is barred with white. This photograph illustrates the Pygmy Owl's characteristic habit of swinging its tail to one side or the other; it will also cock it up like a Wren (*Troglodytes troglodytes*), particularly on alighting (see page 73). This species breeds chiefly in holes in trees, in coniferous or mixed forests in various parts of Europe and across Asia.



Kurt Ellstrom and Einar Sioborg

JUVENILE PYCMY OWL (*Glaucidium passerinum*): SWEDEN, 24TH JUNE 1955.  
 This youngster has just left the nest and is therefore about 28 days old. At this age the upper-parts and breast are largely dark-brownish (see page 73).



Kurt Ellstrom and Einar Sioborg

JUVENILE PYCMY OWLS (*Glaucidium passerinum*): SWEDEN, 24TH JUNE 1955.  
 Note the white "eyebrows" already conspicuous, particularly in the bird on the left (but cf. plate 16). The female, who alone incubates, normally lays 3-7 eggs and starts sitting with the third (see page 73). So that in a large brood there may be some age difference.



Kurt Ellstrom and Einar Sjöberg

ADULT FEMALE PYGMY OWL (*Glaucidium passerinum*); SWEDEN, 12TH JUNE 1955

This shows the pale under-parts, streaked with blackish. The face is brownish-white, and this bird has little sign of the white "eye-brows" that are often a characteristic feature (cf. plate 13); the bill and eyes are yellow. This is mainly a diurnal species, and it is quite a noisy bird—uttering a distinctive, Bullfinch-like whistling. The nest here is in the woodpecker's hole on the left, a favoured site (see page 73).



Ilse Makatsch

BLACK-HEADED GULLS (*Larus ridibundus*) AND BLACK-NECKED GREBE (*Podiceps nigricollis*): GERMANY  
 This photograph of a rather interesting nesting association, between what in Britain are a very common and a very rare breeding species, was taken at one of the Black-headed Gull colonies in the Oberlausitz; it was at these colonies that the ringing discussed on pages 74-77 was carried out. A close view of the Black-necked Grebe has already appeared in *British Birds* (*antea*, vol. 1, plate 8).



R.A.F. Official, Crown Copyright Reserved

VERTICAL VIEW OF ARINACORR, ISLE OF COLL, INNER HEBRIDES: APRIL 1948

For location see right-centre of Fig. 2 on page 43. Apart from the township (on the left of the estuary), this illustrates cultivated areas, moorland, saltings and fresh-water lochs (see list of ecological divisions on page 41). The last-named provide breeding-sites for a few pairs of Red-throated Divers (*Gavia stellata*) (see page 15).



R. L. F. Official, Crown Copyright Reserved

VERTICAL VIEW OF BREACHACHA, ISLE OF COLL, INNER HEBRIDES: APRIL 1949  
 (for location see lower part of Fig. 2 on page 43). Here one can see beaches, dunes  
 peppered with white spots, moorland and lochs. The white spots on the dunes are  
 rabbit warrens and the Buzzards (*Buteo buteo*) hunt here (see page 50). Note the maze  
 of ditches which provide a haven for great numbers of Snipe (*Capella gallinago*)  
 (see page 53).

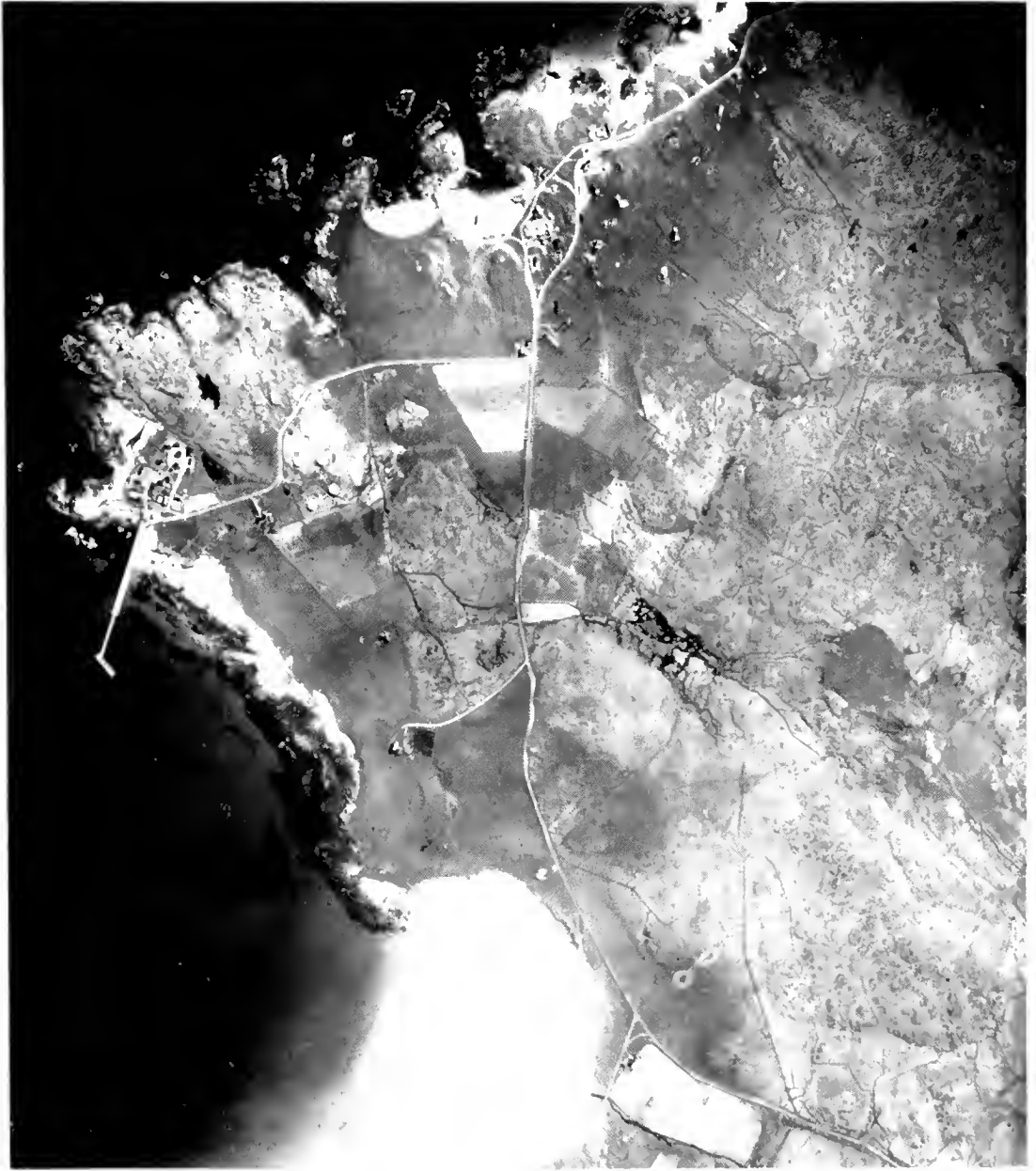

R. A. F. Official, Crown Copyright Reserved

VERTICAL VIEW OF SCARINISH AND GOLF, FIRE, INNER HERRIDES: APRIL 1958.  
For location see right of Fig. 3 on page 44. This shows shell-sand benches, *machair* or sea-meadow, cultivation and crofts, and moorland with fresh waters; the white patches are cultivated *machair* soil unlimed. Note that there are no rabbit warrens (*cf.* plate 19); rabbits have not been present on Fire for at least 100 years (see page 50).



**Sparrowhawk** (*Accipiter nisus*)

9015	+	♀	1.11.54	Loosduinen : 52° 03' N. 4° 12' E. (Zuid Holland)
			23.2.55	Brook : 51° 09' N. 0° 58' E. (Kent)
8995	+	juv. ♀	28.10.53	as above (Holland)
			12.12.55	Tenterden : 51° 04' N. 0° 42' E. (Kent)

**Osprey** (*Pandion haliaëtus*)

J.F.	O	pull.	0.6.56	Glösbo : 61° 20' N. 16° 42' E. (Hälsingland) Sweden
0012	×		9.9.56	Stobs : 55° 23' N. 2° 47' W. (Roxburgh)
6366	O	pull.	25.6.53	Halleberg : 58° 20' N. 12° 25' E. (Västergötland) Sweden
	×		15.11.55	Glen Kyllachy : 57° 17' N. 4° 04' W. (Inverness-shire)

**Water Rail** (*Rallus aquaticus*)

	*	22.8.53	Island of Mellum : 53° 44' N. 8° 14' E. Germany
47092	v	11.1.55	Blackwood : 51° 40' N. 3° 12' W. (Monmouthshire)

After capture, this bird was taken to Cardiff (51° 28' N. 3° 10' W.) and released there.

**Moorhen** (*Gallinula chloropus*)

	*	22.11.54	Piaam : 53° 02' N. 5° 24' E. (Friesland) Holland
93980	×	(cat) 0.12.54	Holme : 52° 58' N. 0° 33' E. (Norfolk)

**Coot** (*Fulica atra*)

	*	4.8.53	Zwarte Meer : 52° 38' N. 6° 00' E. (Overijssel) Holland
9312	+	14.1.56	Hickling Broad : 52° 45' N. 1° 35' E. (Norfolk)

**Oystercatcher** (*Haematopus ostralegus*)

95807	O	pull.	8.7.51	Mikladali : 62° 21' N. 6° 46' W. Faeroes
	×		12.4.52	Birsay : 59° 07' N. 3° 19' W. (Orkney)
95814	O	pull.	8.7.51	as above (Faeroes)
	v	ca.	26.10.51	Belfast : 54° 35' N. 5° 56' W. (Antrim)
95753	O.	ad.	20.6.49	Svinö : 62° 17' N. 6° 18' W. Faeroes
	×		14.1.51	Luce Bay : ca. 54° 50' N. 4° 40' W. (Wigtownshire)
av.	1st	W.	15.10.51	Revtangen : 58° 45' N. 5° 30' E. (Rogaland) Norway
4205	/?/		4.1.53	Hunstanton : 52° 57' N. 0° 30' E. (Norfolk)

**Lapwing** (*Vanellus vanellus*)

282160	O	pull.	5.6.55	Hapsalu : 58° 57' N. 23° 32' E. Estonia
	×		25.3.56	Chatteris : 52° 27' N. 0° 03' E. (Cambridgeshire)
H9943	O	pull.	20.6.55	Fårö : ca. 57° 56' N. 19° 09' E. Gotland, Sweden
	×		4.1.56	Cookstown : 54° 39' N. 6° 45' W. (Tyrone)
E8380	O	pull.	11.5.55	Kristianstad : 56° 02' N. 14° 10' E. Sweden
	×	(long time)	3.8.56	Polzeath : 50° 35' N. 4° 56' W. (Cornwall)
20915	O	pull.	21.6.55	Laholm : 56° 31' N. 13° 05' E. Sweden
	×		23.1.56	Warham : 52° 57' N. 0° 54' E. (Norfolk)
av.	O	pull.	17.6.42	Klepp : 58° 44' N. 5° 32' E. (Rogaland) Norway
607	+		20.12.53	Baltinglass : 52° 56' N. 6° 44' W. (Wicklow)
av.	O	pull.	13.5.50	Sola : 58° 53' N. 5° 37' E. (Rogaland) Norway
9231	+		18.10.54	Castlebar : 53° 51' N. 9° 18' W. (Mayo)
av.	O	pull.	24.5.55	as above (Norway)
7964	×	(wires)	0.2.56	Boulmer : 55° 26' N. 1° 34' W. (Northumberland)
av.	O	pull.	20.5.51	Høyland : 58° 53' N. 5° 45' E. (Rogaland) Norway
2166	×		1.4.52	Malmesbury : 51° 35' N. 2° 05' W. (Wiltshire)

<i>Stav.</i>	O	pull.	22.5.54	as above ( <b>Norway</b> )
603598	(		7.12.54	Chester-le-Street : 54° 50'N. 1° 35'W. (Durham)
<i>Stav.</i>	O	pull.	17.6.52	Tönsberg : 59° 17'N. 10° 22'E. (Vestfold) <b>Norway</b>
604638	+		0.12.52	River Suir : 52° 16'N. 7° 06'W. (Waterford)
<i>Stav.</i>	O	pull.	22.5.54	Hognestad : 58° 43'N. 5° 42'E. (Rogaland) <b>Norway</b>
611766	×		ca.15.1.55	Thurso : 58° 35'N. 3° 33'W. (Caithness)
<i>Stav.</i>	O	pull.	27.5.55	Varhaug : 58° 34'N. 5° 39'E. (Rogaland) <b>Norway</b>
614568	×		31.12.55	Smarden : 51° 09'N. 0° 41'E. (Kent)
C.	O	pull.	5.6.49	Samsö : 55° 55'N. 10° 37'E. <b>Denmark</b>
595512	+		0.1.52	Welney : 52° 31'N. 0° 15'E. (Norfolk)
C.	O	pull.	9.6.51	Praestö : 55° 08'N. 12° 04'E. (Zealand) <b>Denmark</b>
594094	+		9.1.52	Ardee : 53° 51'N. 6° 32'W. (Louth)
H.	O	pull.	11.5.53	Wangeroog : 53° 48'N. 7° 52'E. (East Frisian Is.)
5020479				<b>Germany</b>
	×		19.11.55	Cuerdley : 53° 23'N. 2° 41'W. (Lancashire)
L.	O	pull.	4.6.53	Valkenburg : 52° 10'N. 4° 30'E. (Zuid <b>Holland</b> )
246812	×		14.11.54	South Luffenham : 52° 37'N. 0° 36'W. (Rutland)
L.		♀	19.3.54	Reeuwijk : 52° 03'N. 4° 42'E. (Zuid <b>Holland</b> )
241613	×		4.1.55	Lound : 53° 22'N. 0° 57'W. (Nottinghamshire)
<i>Pe.</i>	O	pull.	1.5.54	Dolín Mecholupy : 50° 03'N. 14° 30'E. <b>Czechoslovakia</b>
H18342	×		6.3.55	Exmouth : 50° 37'N. 3° 24'W. (Devon)

### Ringed Plover (*Charadrius hiaticula*)

H.	O	pull.	13.6.56	Heligoland : 54° 11'N. 7° 55'E. <b>Germany</b>
8871198	+		7.10.56	Courtmacsherry : 51° 38'N. 8° 43'W. (Cork)

### Golden Plover (*Charadrius apricarius*)

<i>Rk.</i>		ad.	28.4.51	Midnes : 64° 04'N. 22° 43'W. <b>Iceland</b>
5/3478	+		13.2.55	Waterford : 52° 15'N. 7° 07'W.
<i>Rk.</i>		ad.	29.4.53	as above ( <b>Iceland</b> )
5/3588	v		9.10.55	<i>ibid.</i>
	+		0.2.56	Athy : 52° 59'N. 6° 59'W. (Kildare)
<i>Rk.</i>		ad.	24.8.55	as above ( <b>Iceland</b> )
76353	+		15.10.55	Cashel : 52° 32'N. 7° 53'W. (Tipperary)
<i>Rk.</i>		ad.	8.10.55	as above ( <b>Iceland</b> )
75801	+		12.2.56	Dunany : 53° 52'N. 6° 16'W. (Louth)
<i>Rk.</i>		ad.	29.10.55	as above ( <b>Iceland</b> )
75839	+		15.1.56	Banteer : 52° 07'N. 8° 54'W. (Cork)

### Turnstone (*Arenaria interpres*)

<i>Rk.</i>		ad.	24.8.55	Midnes : 64° 04'N. 22° 43'W. <b>Iceland</b>
76354	×		16.5.56	Maidens Lighthouse : 54° 56'N. 5° 45'W. (Antrim)
<i>Stav.</i>	*		28.8.55	Revtangen : 58° 45'N. 5° 30'W. (Rogaland) <b>Norway</b>
730125	+		23.9.55	West Mersea : 51° 46'N. 0° 55'E. (Essex)

### Snipe (*Capella gallinago*)

<i>Rk.</i>	O	pull.	13.7.48	Myvatn : 65° 39'N. 16° 58'W. <b>Iceland</b>
6/4835	+		30.10.55	Tarbert : 52° 34'N. 9° 23'W. (Kerry)
<i>Rk.</i>	O	pull.	24.6.54	Fnjóskadalur : 65° 46'N. 17° 53'W. <b>Iceland</b>
85285	+		9.12.55	Tralee : 52° 16'N. 9° 43'W. (Kerry)
<i>Rk.</i>	O	pull.	3.7.54	as above ( <b>Iceland</b> )
85256	×	(wires)	17.2.55	Tresco : 49° 58'N. 6° 20'W. (Isles of Scilly)

<i>Rk.</i>	O	ad.	13.6.55	Hornafjordur : 64° 17'N. 15° 12'W. <b>Iceland</b>
777902	+		0.10.55	South Uist or Benbecula (Outer Hebrides)
<i>St.</i>	O	pull.	14.6.55	Frändefors : 58° 29'N. 12° 18'E. <b>Sweden</b>
YK6967	+		28.1.56	Ballygar : 53° 32'N. 8° 19'W. (Galway)
<i>C.</i>		ad.	29.9.50	Copenhagen : 55° 41'N. 12° 35'E. <b>Denmark</b>
694346	+		27.1.51	Sandford-on-Thames : 51° 43'N. 1° 13'W. (Oxfordshire)
<i>C.</i>		ad.	7.8.51	Amager : 55° 40'N. 12° 38'E. <b>Denmark</b>
781048	×		1.12.52	Maybole : 55° 21'N. 4° 41'W. (Ayrshire)
<i>C.</i>	*		10.9.51	as above ( <b>Denmark</b> )
781292	+		2.1.52	Stafford : 52° 49'N. 2° 06'W.
<i>C.</i>	*		24.8.54	as above ( <b>Denmark</b> )
697098	+		0.2.55	Bampton : 50° 59'N. 3° 29'W. (Devon)
<i>H.</i>	*		18.8.51	Wilhelmshaven : 53° 32'N. 8° 08'E. <b>Germany</b>
7177667	+		1.1.55	Sidlesham : 50° 47'N. 0° 48'W. (Sussex)
<i>B.</i>	*		8.8.50	Le Zoute : 51° 20'N. 3° 17'E. (West Flanders) <b>Belgium</b>
33D1057	+		5.2.55	Clara : 53° 21'N. 7° 36'W. (Offaly)

### Woodcock (*Scolopax rusticola*)

<i>Hki.R.S.</i>		1954 or/55	Oulu : 65° 00'N. 25° 30'E. <b>Finland</b>
111803	+	19.11.55	Knockholt : 51° 19'N. 0° 07'E. (Kent)

### Curlew (*Numenius arquata*)

<i>Hki.</i>	O	pull.	30.5.37	Muolaa : 60° 37'N. 29° 25'E. <b>Finland</b>
C27223	+		30.11.55	Lough Gur : 52° 32'N. 8° 32'W. (Limerick)
<i>Hki.</i>	O	pull.	6.6.52	Sumiainen : 62° 39'N. 26° 03'E. <b>Finland</b>
C36056	+		0.12.53	Hesketh Bank : 53° 42'N. 2° 51'W. (Lancashire)
<i>Stav.</i>	O	pull.	14.6.53	Herøy : 65° 54'N. 12° 00'E. (Nordland) <b>Norway</b>
444077	×		1.2.55	Loch Snizort : ca.57° 35'N. 6° 25'W. (Isle of Skye)
<i>Stav.</i>	O	pull.	20.5.50	Fosse : 58° 42'N. 5° 42'E. (Rogaland) <b>Norway</b>
444398	+		26.12.55	Strangford Lough : ca.54° 30'N. 5° 33'W. (Down)
<i>S.J.F.</i>	O	pull.	10.7.54	Lau Myr : 57° 15'N. 18° 33'E. (Gotland) <b>Sweden</b>
442287	×	(wires)	1.11.54	Backford : 53° 15'N. 2° 55'W. (Cheshire)
<i>G.</i>	O	pull.	27.6.54	Hultsjö : 57° 18'N. 14° 43'E. (Småland) <b>Sweden</b>
D.41527	+		15.1.55	Breydon Water : ca.52° 37'N. 1° 42'E. (Norfolk)

Note the age of 18 years attained by the first bird on the list. *Stavanger* 444399, from the same clutch as 44398 above, was recovered in September 1950, also at Strangford Lough (*antea*, vol. xlv, p. 464).

### Bar-tailed Godwit (*Limosa lapponica*)

<i>Stav.</i>		juv.	19.8.55	Revtangen : 58° 45'N. 5° 30'E. (Rogaland) <b>Norway</b>
6605462	+		0.2.56	Breydon Water : ca.52° 37'N. 1° 42'E. (Norfolk)

### Redshank (*Tringa totanus*)

<i>Rk.</i>		juv.	1.8.55	Midnes : 64° 04'N. 22° 43'W. <b>Iceland</b>
776190	×		6.7.56	Blackwater Foot : 55° 30'N. 5° 20'W., Isle of Arran (Bute)
<i>C.</i>		juv.	31.7.51	Amager : 55° 40'N. 12° 38'E. <b>Denmark</b>
780961	+		9.2.52	Mersea Island : 51° 47'N. 0° 58'E. (Essex)

### Knot (*Calidris canutus*)

<i>Rk.</i>	*		30.5.55	Midnes : 64° 04'N. 22° 43'W. <b>Iceland</b>
776160	+		14.12.55	Rosslare : 52° 21'N. 6° 24'W. (Wexford)

<i>Rk.</i>	ad.	23.8.55	as above ( <b>Iceland</b> )
76324	v	4.11.56	Flookburgh : 54° 11'N. 2° 59'W. (Lancashire)
<i>Stav.</i>	*	18.8.48	Revtangen : 58° 45'N. 5° 30'E. (Rogaland) <b>Norway</b>
88854	+	24.1.55	Blakeney : 52° 58'N. 1° 01'E. (Norfolk)
<i>Stav.</i>	*	23.8.49	as above ( <b>Norway</b> )
11586	+	9.1.55	Wentloog : 51° 31'N. 3° 02'W. (Monmouthshire)
<i>Stav.</i>	ad.	2.9.49	as above ( <b>Norway</b> )
12615	+	3.1.52	Gedney Drove End : 52° 51'N. 0° 11'E. (Lincolnshire)
<i>Stav.</i>	ad.	21.9.52	as above ( <b>Norway</b> )
723327	×	26.12.52	Monifieth : 56° 29'N. 2° 49'W. (Angus)
<i>Stav.</i>	ad.	24.9.52	as above ( <b>Norway</b> )
723421	+	ca.10.12.52	Maldon : 51° 44'N. 0° 40'E. (Essex)

### Dunlin (*Calidris alpina*)

<i>Stav.</i>	*	ad.	21.9.50	Revtangen : 58° 45'N. 5° 30'E. (Rogaland) <b>Norway</b>
8391	×	(nets)	22.1.52	Morecambe Bay : ca. 54° 00'N. 3° 00'W. (Lancashire)
<i>Stav.</i>	*		21.9.50	as above ( <b>Norway</b> )
Z231	+		5.12.52	Stoke Marshes : 51° 27'N. 0° 38'E. (Kent)
<i>Stav.</i>	*		20.8.51	as above ( <b>Norway</b> )
9383	+		20.2.52	River Clwyd : 53° 18'N. 3° 28'W. (Flintshire)
<i>Stav.</i>	*		14.9.51	as above ( <b>Norway</b> )
814626	+		4.1.53	Maldon : 51° 44'N. 0° 40'E. (Essex)
<i>Stav.</i>	*		27.9.51	as above ( <b>Norway</b> )
815267	×		8.1.52	Skegness : 53° 10'N. 0° 20'E. (Lincolnshire)
<i>Stav.</i>	*		27.9.51	as above ( <b>Norway</b> )
815209	×		11.2.52	Aldeburgh : 52° 09'N. 1° 36'E. (Suffolk)
<i>Stav.</i>	*		26.9.52	as above ( <b>Norway</b> )
82269	×		9.2.56	Port Carlisle : 54° 57'N. 3° 11'W. (Cumberland)
<i>Stav.</i>	*		27.9.52	as above ( <b>Norway</b> )
822554	+		16.10.52	Malltraeth : ca. 53° 10'N. 4° 25'W. (Anglesey)
<i>Stav.</i>	*		4.10.52	as above ( <b>Norway</b> )
723639	×		15.11.52	Langstone Harbour : 50° 46'N. 1° 03'W. (Hampshire)
<i>Stav.</i>	*		25.8.54	as above ( <b>Norway</b> )
833459	×		7.10.56	Bromborough : 53° 20'N. 2° 58'W. (Cheshire)
<i>Stav.</i>	*		26.9.55	as above ( <b>Norway</b> )
840818	×		0.2.56	Oulton Broad : 52° 28'N. 1° 43'E. (Suffolk)
<i>Stav.</i>	*		29.8.56	as above ( <b>Norway</b> )
832890	+		7.11.56	Warsash : 50° 51'N. 1° 18'W. (Hampshire)
<i>Stav.</i>	*		23.9.56	as above ( <b>Norway</b> )
835531	+		21.10.56	Snettisham : 52° 53' N. 0° 30'E. (Norfolk)
<i>Stav.</i>	*		24.9.56	as above ( <b>Norway</b> )
834660	+		5.10.56	Breydon Water : ca. 52° 37'N. 1° 42'E. (Norfolk)
<i>Stav.</i>	*		18.9.55	Lista : 58° 06'N. 6° 37'E. (Vest-Agder) <b>Norway</b>
846180	×		20.9.55	Winterton : 52° 43'N. 1° 42'E. (Norfolk)
<i>St. Orn.</i>	ad.		7.7.53	Ottenby : 56° 13'N. 16° 25'E. Öland, <b>Sweden</b>
101006	+		6.2.55	Ballysodare Bay : 54° 13'N. 8° 31'W. (Sligo)
<i>St. Orn.</i>	ad.		15.8.53	as above ( <b>Sweden</b> )
503900	×		ca.29.12.55	Morecambe Bay : ca. 54° 00'N. 3° 00'W. (Lancashire)
<i>St. Orn.</i>	juv.		28.8.53	as above ( <b>Sweden</b> )
504314	×		14.2.54	River Aire : (Yorkshire)
<i>St. Orn.</i>	ad.		27.7.54	as above ( <b>Sweden</b> )
506966	+		9.12.55	Bradwell : 51° 44'N. 0° 54'E. (Essex)

St. Orn.	*	28.7.54	as above ( <b>Sweden</b> )
07264	×	15.11.56	Chichester : 50° 50'N. 0° 47'W. (Sussex)
St. Orn.	juv.	13.9.54	as above ( <b>Sweden</b> )
14240	+	5.1.56	Winterringham : 53° 42'N. 0° 34'W. (Lincolnshire)
St.	ad.	15.8.49	as above ( <b>Sweden</b> )
LOA8399	(leg--bone)	17.8.55	Rock : 50° 34'N. 4° 56'W. (Cornwall)
St.	ad.	22.7.52	as above ( <b>Sweden</b> )
YO7558	×	0.2.54	Bridlington : 54° 06'N. 0° 12'W. (Yorkshire)
St.	ad.	1.8.51	Amager : 55° 40'N. 12° 38'E. <b>Denmark</b>
881653	+	14.1.52	Bosham : 50° 50'N. 0° 52'W. (Sussex)
St.	ad.	4.8.51	as above ( <b>Denmark</b> )
881693	×	autumn 1953	Camel Estuary : ca. 50° 32'N. 4° 52'W. (Cornwall)
St.	*	18.8.52	as above ( <b>Denmark</b> )
883129	+	8.1.56	Bradfield : 51° 56'N. 1° 07'E. (Essex)
St.	*	6.10.53	as above ( <b>Denmark</b> )
887839	×	(wires) 0.2.55	Abbotsbury : 50° 40'N. 2° 36'W. (Dorset)

### Sanderling (*Crocethia alba*)

Stav.	*	26.8.51	Revtangen : 58° 45'N. 5° 30'E. (Rogaland) <b>Norway</b>
113857	×	(oiled) 14.2.56	Great Yarmouth : 52° 36'N. 1° 45'E. (Norfolk)
Stav.	*	23.9.55	as above ( <b>Norway</b> )
129483 } 33315 }	+	14.10.55	Walton-on-the-Naze : 51° 51'N. 1° 18'E. (Essex)

### Great Black-backed Gull (*Larus marinus*)

Rk.	O	pull.	30.5.54	Hörgárdalur : 65° 47'N. 18° 12'W. <b>Iceland</b>
55838	+		4.12.55	Tuam : 53° 31'N. 8° 51'W. (Galway)
Rk.	O	pull.	12.7.55	as above ( <b>Iceland</b> )
6155	×		10.10.55	Workington : 54° 39'N. 3° 34'W. (Cumberland)
Stav.	O	pull.	16.6.52	Kinn : 61° 35'N. 4° 44'E. <b>Norway</b>
66439	×		12.4.54	Isle of Sheppey : 51° 22'N. 0° 55'E. (Kent)
Stav.	O	pull.	22.6.53	as above ( <b>Norway</b> )
66222	+		20.2.54	Grinsby : 53° 34'N. 0° 05'W. (Lincolnshire)
Stav.	O	pull.	6.7.54	Hovden : 61° 43'N. 4° 53'E. <b>Norway</b>
08959	×		3.8.55	Filey : 54° 15'N. 0° 20'W. (Yorkshire)
Stav.	O	pull.	6.7.54	as above ( <b>Norway</b> )
08908	×		5.9.54	Anstruther : 56° 13'N. 2° 43'W. (Fife)
Stav.	O	pull.	5.7.55	Bremanger : 61° 44'N. 4° 57'E. <b>Norway</b>
55848	×		19.11.55	Ribble Estuary : ca. 53° 45'N. 2° 55'W. (Lancashire)
Stav.	O	pull.	14.6.53	Rott : 58° 55'N. 5° 30'E. (Rogaland) <b>Norway</b>
6075	×		16.5.54	Redcar : 54° 36'N. 1° 05'W. (Yorkshire)
Stav.	O	pull.	26.6.55	as above ( <b>Norway</b> )
115310	×		25.2.56	Walton Reservoir : 51° 25'N. 0° 24'W. (Surrey)
Stav.	O	pull.	18.6.52	Klepp : 58° 44'N. 5° 33'E. (Rogaland) <b>Norway</b>
55777	×		13.12.52	Hevingham : 52° 44'N. 1° 16'E. (Norfolk)

### Lesser Black-backed Gull (*Larus fuscus*)

Stav.	O	pull.	4.7.55	Naerøy : 61° 38'N. 4° 58'E. <b>Norway</b>
5991	×		7.9.55	Southrepps : 52° 55'N. 1° 21'E. (Norfolk)
Stav.	O	pull.	30.6.54	Rott : 58° 55'N. 5° 30'E. (Rogaland) <b>Norway</b>
10467	×		30.4.55	Winterringham : 53° 40'N. 0° 30'W. (Lincolnshire)

<i>Stav.</i>	O	pull.	9.6.54	Herøy : 58° 04' N. 7° 52' E. (Vest-Agder) <b>Norway</b>
508317	×		ca. 10.7.55	Stainforth : 53° 36' N. 1° 03' W. (Yorkshire)
<i>G.</i>	O	pull.	13.7.53	Fjällbacka : 58° 36' N. 11° 18' E. (Bohus) <b>Sweden</b>
D.41727	×		16.8.56	Hemsby : 52° 42' N. 1° 41' E. (Norfolk)

### Herring Gull (*Larus argentatus*)

<i>Stav.</i>	O	pull.	7.7.52	Vesterålen : 69° 17' N. 16° 00' E. <b>Norway</b>
308304	×		ca. 5.12.55	Kyle of Lochalsh : 57° 17' N. 5° 43' W. (Ross)
<i>Stav.</i>	O	pull.	10.7.55	as above ( <b>Norway</b> )
413742	×		13.3.56	Whitby : 54° 29' N. 0° 36' W. (Yorkshire)
<i>Stav.</i>	O	pull.	28.6.51	Hovden : 61° 43' N. 4° 53' E. <b>Norway</b>
45746	×		24.8.52	Birchington : 51° 23' N. 1° 20' E. (Kent)
<i>Stav.</i>	O	pull.	5.6.52	Naerøy : 61° 38' N. 4° 58' E. <b>Norway</b>
36403	×	(long time)	9.7.53	Thorntonloch : 55° 56' N. 2° 25' W. (E. Lothian)

### Common Gull (*Larus canus*)

and

### Black-headed Gull (*Larus ridibundus*)

Numbers of ringed birds of these two species, from Norway and from the countries surrounding the Baltic Sea, are recovered annually in winter. In addition, Black-headed Gulls from breeding-quarters in Central Europe winter regularly in the British Isles, and two Iceland-bred birds of this species were recovered in November 1956 in Shetland and at Inverness. Reports of either species as winter-visitors to Ireland from the Continent are still rather rare.

### Iceland Gull (*Larus glaucooides*)

<i>C.</i>	O	pull.	2.8.54	Strömfjord : 67° 50' N. 50° 30' W. <b>Greenland</b>
378816	v		15.1.55	Fraserburgh : 57° 41' N. 2° 00' W. (Aberdeenshire)

### Common Tern (*Sterna hirundo*)

<i>Hki.</i>	O	pull.	11.7.53	Valsöarna : 63° 25' N. 21° 10' E. <b>Finland</b>
A43533	/?		19.9.53	English Channel : ca. 49° 00' N. 6° 00' W.
<i>H.</i>	O	pull.	24.6.49	Plöner See : 54° 10' N. 10° 27' E. (Schleswig-Holstein <b>Germany</b> )
6130679	×	(long time)	17.9.55	Canvey Point : 51° 32' N. 0° 40' E. (Essex)
<i>H.</i>	O	pull.	2.7.56	Wangeroog : 53° 48' N. 7° 52' E. (East Frisian Is. <b>Germany</b> )
7257688	×		12.9.56	Rye Harbour : 50° 56' N. 0° 46' E. (Sussex)
<i>L.</i>	O	pull.	14.6.56	Reeuwijk : 52° 03' N. 4° 42' E. (Zuid <b>Holland</b> )
K49285	×		22.8.56	Penzance : 50° 07' N. 5° 33' W. (Cornwall)

### Arctic Tern (*Sterna macrura*)

<i>M.</i>	O	pull.	20.6.56	Puhtu : 58° 34' N. 23° 34' E. <b>Estonia</b>
F301152	×		4.9.56	Little Somerford : 51° 34' N. 2° 03' W. (Wiltshire)
<i>H.</i>	O	ad.	8.6.53	Oldeog : 53° 48' N. 7° 52' E. (East Frisian Is.) <b>Germany</b>
7131914	×		20.8.55	Benacre : 52° 24' N. 1° 43' E. (Suffolk)

The tern with the Moscow ring was from the most easterly locality of origin so far recorded, southern Sweden having up to now been the limit in that direction. The manner of its recovery was unusual, as was the place in which it was found, for it made repeated dives at a fisherman's bait while he was fishing for pike in a mill-pond, until at last it struck the top of the rod and broke its wing.

**Sandwich Tern** (*Sterna sandvicensis*)

L.	O	pull.	28.6.47	Hook of Holland: 51° 58' N. 4° 06' E. (Zuid Holland)
214532	v		12.6.56	Solent, Isle of Wight (Hampshire)

**Stock Dove** (*Columba oenas*)

Hki.	O	pull.	23.7.54	Tyrväntö : 61° 14' N. 24° 20' E. Finland
C46308	+		0.3.55	Ormesby : 52° 41' N. 1° 43' E. (Norfolk)

With the exception of one ringed in Holland and recovered in Buckinghamshire in 1940, this is the only Stock Dove from a foreign country.

**Long-eared Owl** (*Asio otus*)

St.	*	19.10.52	Falsterbo : 55° 23' N. 12° 50' E. Sweden
S9020	x	16.3.56	Selby : 53° 47' N. 1° 04' W. (Yorkshire)

**Rook** (*Corvus frugilegus*)

C.	O	ad.	4.6.50	Töllöse : 55° 37' N. 11° 47' E. (Zealand) Denmark
493356	x		25.10.52	Binbrook : 53° 26' N. 0° 11' W. (Lincolnshire)

**Fieldfare** (*Turdus pilaris*)

O.	O	pull.	4.6.53	egge : 64° 05' N. 11° 25' E. (Nord Trøndelag) Norway
064988	x		ca.10.5.54	Danby : 54° 27' N. 0° 54' W. (Yorkshire)
O.	O	pull.	21.6.55	Egersund : 58° 28' N. 6° 00' E. (Rogaland) Norway
086605	x		24.3.56	Goff's Oak : 51° 43' N. 0° 05' W. (Hertfordshire)
O.	O	pull.	9.6.51	Laerdal : 61° 02' N. 7° 34' E. Norway
30336	/?/		6.1.52	Preston : 53° 46' N. 2° 43' W. (Lancashire)
O.	O	pull.	3.6.51	Skøyen : 59° 54' N. 10° 46' E. (Oslo) Norway
31917	x		21.3.54	Belfast : 54° 35' N. 5° 56' W. (Antrim)
Stav.	O	pull.	1.6.52	Ål : 60° 37' N. 8° 30' E. (Hallingdal) Norway
718647	x		20.3.54	Grassington : 54° 04' N. 2° 00' W. (Yorkshire)
Stav.	O	pull.	19.5.52	Høyland : 58° 50' N. 5° 45' E. (Rogaland) Norway
715712	x		0.12.52	Hatfield : 53° 35' N. 1° 00' W. (Yorkshire)
Stav.	O	pull.	21.6.54	Egersund : (Rogaland) Norway
337310	x		6.3.55	Bellshill : 55° 49' N. 4° 02' W. (Lanarkshire)
Stav.	O	pull.	24.5.52	Evje : 58° 39' N. 7° 47' E. (Aust-Agder) Norway
713409	x		16.4.53	Holbeach : 52° 48' N. 0° 03' E. (Lincolnshire)
Stav.	O	pull.	3.6.53	Stokke : 59° 14' N. 10° 20' E. (Vestfold) Norway
717717	x		17.4.55	Whitley Bay : 55° 03' N. 1° 26' W. (Northumberland)

**Song Thrush** (*Turdus philomelos*)

H.	*	30.4.55	Island of Mellum : 53° 44' N. 8° 14' E. Germany
8823903	x	0.2.56	Stanford-le-Hope : 51° 31' N. 0° 26' E. (Essex)

**Redwing** (*Turdus musicus*)

Hki.	O	pull.	23.6.52	Tyrväntö : 61° 12' N. 24° 15' E. Finland
A41703	x		30.4.56	Torquay : 50° 27' N. 3° 30' W. (Devon)
Hki.	ad.	14.4.53	Signilskär : 60° 12' N. 19° 22' E. (Åland Is.) Finland	
A41215	x		6.3.56	Mylor Bridge : 50° 11' N. 5° 04' W. (Cornwall)
Hki.	O	pull.	22.6.55	Korsholm : 63° 08' N. 21° 42' E. Finland
A56582	x		23.2.56	Laugharne : 51° 46' N. 4° 28' W. (Carmarthenshire)
Hki.	O	pull.	22.6.55	Tampere : 61° 33' N. 23° 35' E. Finland
A58086	x		13.12.55	Thurnham : 51° 18' N. 0° 37' E. (Kent)

**Blackbird (*Turdus merula*)**

<i>St.</i>	O	pull.	17.5.53	Ankarsrum : 57° 41'N. 16° 20'E. (Kalmar) <b>Sweden</b>
YB1769	×		14.2.55	Smarden : 51° 09'N. 0° 41'E. (Kent)
<i>St.</i>	O	pull.	1.8.55	Nysund : 59° 06'N. 14° 22'E. (Örebro) <b>Sweden</b>
YK8828	+		0.2.56	Hassocks : 50° 55'N. 0° 10'W. (Sussex)
<i>Stav.</i>	O	pull.	10.5.51	Sandnes : 58° 51'N. 5° 43'E. (Rogaland) <b>Norway</b>
11896	×		17.2.52	Kibblesworth : 54° 54'N. 1° 38'W. (Durham)
<i>Stav.</i>	♀		17.3.54	Ranvik : 59° 07'N. 10° 14'E. (Vestfold) <b>Norway</b>
722283	×		12.11.55	Fawdon : 55° 01'N. 1° 39'W. (Northumberland)
<i>Stav.</i>	♀		31.3.54	as above ( <b>Norway</b> )
823999	×		17.1.55	Dersingham : 52° 51'N. 0° 31'E. (Norfolk)
<i>Stav.</i>	♂		26.3.55	Frøyland : 58° 21'N. 6° 18'E. (Rogaland) <b>Norway</b>
87573	×		0.1.56	Bilsthorpe : 53° 08'N. 1° 02'W. (Nottinghamshire)
<i>Stav.</i>	O	pull.	1.7.55	Birkeland : 58° 21'N. 6° 18'E. (Rogaland) <b>Norway</b>
740951	+		13.1.56	Rooskey : 53° 50'N. 7° 56'W. (Roscommon)
<i>Stav.</i>	♀		30.10.55	Lindland : 58° 21'N. 6° 18'E. (Rogaland) <b>Norway</b>
740843	×	(cat)	7.2.56	Swanton Abbott : 52° 47'N. 1° 22'E. (Norfolk)
<i>C.</i>	O	pull.	28.5.47	Bregentved : 55° 19'N. 12° 00'E. (Zealand) <b>Denmark</b>
792532	×		20.3.51	Saxby : 53° 22'N. 0° 29'W. (Lincolnshire)
<i>C.</i>	O	pull.	16.6.50	Copenhagen : 55° 41'N. 12° 35'E. <b>Denmark</b>
780354	×		14.2.52	Low Moorsley : 54° 48'N. 1° 28'W. (Durham)
<i>H.</i>	♀		21.3.52	Spiekerroog : 53° 47'N. 7° 42'E. (East Frisian Is.) <b>Germany</b>
7171678	v		0.1.55	Kildalkey : 53° 34'N. 6° 54'W. (Meath)
<i>H.</i>	♀		20.1.55	Winsen/Luhe : 53° 23'N. 10° 13'E. (Hanover) <b>Germany</b>
7195411	+		3.12.55	Melton Constable : 52° 52'N. 1° 01'E. (Norfolk)
<i>H.</i>	♀		12.4.55	Heligoland : 54° 11'N. 7° 55'E. <b>Germany</b>
7232077	v		1.11.55	Spurn Bird Obs. : 53° 36'N. 0° 10'E. (Yorkshire)
<i>H.</i>	♀		24.10.55	as above ( <b>Germany</b> )
7232273	v		8.4.56	Dungeness Bird Obs. : 50° 55'N. 0° 59'E. (Kent)
<i>H.</i>	♀		29.10.55	as above ( <b>Germany</b> )
7232467	×	(hawk)	0.11.56	Wark : 55° 05'N. 2° 13'W. (Northumberland)
<i>H.</i>	♀		1.11.55	as above ( <b>Germany</b> )
7232521	×		27.12.55	St. Peter's : 51° 22'N. 1° 26'E. (Kent)
<i>H.</i>	♀		23.3.56	Island of Mellum : 53° 44'N. 8° 14'E. <b>Germany</b>
7224664	×		8.12.56	Quidenham : 52° 27'N. 0° 58'E. (Norfolk)
<i>B.</i>	O	pull.	12.6.55	St. Job-in-'t-Goor : 51° 14'N. 4° 39'E. (Antwerp) <b>Belgium</b>
3C1557	×		21.2.56	Shaftesbury : 51° 01'N. 2° 11'W. (Dorset)

**Wheatear (*Oenanthe oenanthe*)**

<i>Rk.</i>	O	pull.	20.6.56	Skipalón : 65° 47'N. 18° 12'W. <b>Iceland</b>
94832	v		10.9.56	Bardsey Bird Obs. : 52° 46'N. 4° 48'W. (Caernarvonshire)

The ring was inadvertently removed, and the bird, if still alive, now carries the British number C.49407.

**White Wagtail (*Motacilla alba alba*)**

<i>Rk.</i>	O	pull.	20.6.56	Laugaból : 65° 43'N. 17° 21'W. <b>Iceland</b>
93275	×	(long time)	24.10.56	Lundy : 51° 12'N. 4° 40'W. (Devon)

The only other foreign-ringed White Wagtail recovered in the British Isles was also a nestling from Iceland; it was found on board a ship off Rockall (57° 40'N. 13° 30'W.) in September 1928, less than three months after ringing.



**Starling (*Sturnus vulgaris*)**

M.	O	♀	8.5.53	Rybinsk area : 58° 30'N. 37° 30'E. <b>Russia</b>
F132120	v		15.5.54	<i>ibid.</i>
3 rings)	v		24.2.55	Thornaby-on-Tees : 54° 33'N. 1° 18'W. (Yorkshire)
M.	O	♂	16.5.53	Riga : 56° 57'N. 24° 09'E. <b>Latvia</b>
F150045	+		11.2.55	Clifton : 52° 02'N. 0° 19'W. (Bedfordshire)
M.	?		1.6.54	Malo Yaroslavetz : 55° 03'N. 36° 25'E. <b>Russia</b>
F20961	—v		0.1.56	Buckland Brewer : 50° 58'N. 4° 16'W. (Devon)
M.	O	pull.	4.6.55	Elva : 58° 13'N. 26° 25'E. <b>Estonia</b>
F208992	×		19.2.56	Wellesbourne : 52° 12'N. 1° 36'W. (Warwickshire)
Hki.	O	pull.	25.5.53	Renko : 60° 52'N. 24° 20'E. <b>Finland</b>
A46091	×		11.3.54	Holmrook : 54° 23'N. 3° 25'W. (Cumberland)
Hki.	O	pull.	27.5.54	Hamina : 60° 35'N. 27° 12'E. <b>Finland</b>
A.53605	×		0.2.56	Martin : 53° 08'N. 0° 21'W. (Lincolnshire)
Hki.	O	pull.	7.6.55	Kemiö : 60° 08'N. 22° 45'E. <b>Finland</b>
B323052	×	winter	1955/56	Worthing : 50° 49'N. 0° 23'W. (Sussex)
a.a.	O	pull.	1.6.54	Kaunas : 54° 54'N. 23° 54'E. <b>Lithuania</b>
F28978	×	ca.	1.3.56	Marazion : 50° 06'N. 5° 29'W. (Cornwall)
P.V.	O	pull.	23.5.54	Nowogard : 53° 40'N. 15° 08'E. <b>Poland</b>
F142247	×		12.2.56	Steventon : 51° 37'N. 1° 19'W. (Berkshire)
P.V.	O	pull.	27.5.54	Olsztyn : 53° 46'N. 20° 29'E. <b>Poland</b>
F173389	+		25.2.55	Kingswinford : 52° 29'N. 2° 10'W. (Staffordshire)
P.V.	O	pull.	30.5.54	Pisz : 53° 35'N. 21° 31'E. <b>Poland</b>
F173602	×	(cat)	6.12.55	Pewsey : 51° 20'N. 1° 46'W. (Wiltshire)
P.V.	O	pull.	30.5.55	Dziubiele : 53° 48'N. 21° 40'E. <b>Poland</b>
F186278	×		18.3.56	Birmingham : 52° 28'N. 1° 55'W. (Warwickshire)
H.	O	pull.	24.5.54	Stenkyrka : 57° 48'N. 18° 31'E. (Gotland) <b>Sweden</b>
FH6208	×		25.2.55	Stalham : 52° 47'N. 1° 32'E. (Norfolk)
H.	O	pull.	29.5.54	as above ( <b>Sweden</b> )
FH6210	+		0.2.56	Billingham : 54° 36'N. 1° 17'W. (Durham)

The above selections are made from an annual long list of Starlings ringed in northern Europe and recovered as winter-visitors to the British Isles. The greater number have been ringed on migration, but the records quoted above are all of birds ringed in their native countries.

Below are given two more examples of birds that were taken away from their migration-route and yet orientated themselves successfully.

	juv.		27.10.53	Loosduinen : 52° 04'N. 4° 15'E. <b>Holland</b> ; transported
F20894				Zürich : 47° 22'N. 8° 33'E. <b>Switzerland</b>
	+		0.2.56	Pampisford : 52° 07'N. 0° 11'E. (Cambridgeshire)
		♀	1.11.54	as above ( <b>Holland and Switzerland</b> )
F23188	×		24.2.56	Newbridge : 50° 08'N. 5° 37'W. (Cornwall)

**Linnet (*Carduelis cannabina*)**

	ad.		26.4.53	Brasschaat : 51° 17'N. 4° 29'E. (Antwerp) <b>Belgium</b>
A1023	×		16.6.55	Thetford : 52° 25'N. 0° 45'E. (Norfolk)

**Chaffinch (*Fringilla coelebs*)**

Hki.	*	♂	10.10.55	Signilskär : 60° 12'N. 19° 22'E. (Åland Is.) <b>Finland</b>
F8194	v		12.11.55	Brentwood : 51° 38'N. 0° 18'E. (Essex)
	O	pull.	12.6.55	Livskogen : 60° 05'N. 10° 30'E. <b>Norway</b>
F95495	v		1.11.55	Saltee Bird Obs. : 52° 07'N. 6° 35'W. (Wexford)

<i>Stav.</i>	ad.	10.4.53	Omdal : 58° 24'N. 6° 24'E. (Rogaland) <b>Norway</b>
923309	×	0.2.54	Cork : 51° 53'N. 8° 30'W.
<i>L.</i>	1st W. ♂	5.11.54	Loosduinen : 52° 03'N. 4° 12'E. (Zuid <b>Holland</b> )
H28657	v	28.10.56	Romford : 51° 35'N. 0° 11'E. (Essex)
<i>B.</i>	*	17.10.54	Antwerp : 51° 13'N. 4° 25'E. <b>Belgium</b>
5B69	×	1.3.55	Cranbrook : 51° 06'N. 0° 33'E. (Kent)
<i>B.</i>	ad.	12.10.55	Wijnegem : 51° 13'N. 4° 32'E. (Antwerp) <b>Belgium</b>
15B2414	×	15.12.55	Drumshambo : 54° 03'N. 8° 03'W. (Leitrim)
<i>B.</i>	* ♀	12.10.56	St. Job-in-'t-Goor : 51° 14'N. 4° 39'E. <b>Belgium</b>
17A6263	v	23.10.56	Llandovery : 51° 56'N. 3° 53'W. (Carmarthenshire)
<i>B.</i>	* ♂	31.10.54	Heist : 51° 20'N. 3° 14'E. (West Flanders) <b>Belgium</b>
6B7567	×	26.2.55	Wingham : 51° 16'N. 1° 14'E. (Kent)
<i>B.</i>	* ♂	10.10.56	Warneton : 50° 46'N. 2° 57'E. (West Flanders) <b>Belgium</b>
14B815	×	0.11.56	Goodwick : 52° 01'N. 5° 00'W. (Pembrokeshire)

### Brambling (*Fringilla montifringilla*)

<i>Pe.</i>	ad. ♂	2.3.55	Praha-Ruzyne : 50° 05'N. 14° 19'E. <b>Czechoslovakia</b>
M255743	v	18.4.56	Dublin : 53° 21'N. 6° 16'W.
<i>B.</i>	* ♂	30.10.55	Le Zoute : 51° 20'N. 3° 17'E. (West Flanders) <b>Belgium</b>
12B3177	v	20.2.56	Hythe : 51° 04'N. 1° 06'E. (Kent)

## PHOTOGRAPHIC STUDIES OF SOME LESS FAMILIAR BIRDS

### LXXXV. PYGMY OWL

Photographed by KURT ELLSTRÖM, SIGVARD ROSÉN  
and ENAR SJÖBERG

(Plates 13-16)

Text by KAI CURRY-LINDAHL

THE PYGMY OWL (*Glaucidium passerinum*) is a Palearctic species which has not yet been recorded in Britain, though in western Europe the typical form is found in central and northern Scandinavia, Finland, French Jura, the Alps (including Switzerland, Italy and Austria), and in parts of southern and eastern Germany. Its main distribution, however, lies to the east, in a fairly narrow belt some 300-600 miles wide, across central Russia and Siberia as far as the upper reaches of the Yenisei and Tunguska rivers; there it is replaced by another race whose range extends in this way across to the eastern side of the Asiatic mainland (Manchuria and the Amur river). Although it is chiefly a resident bird some individuals do, during the winter, straggle quite far from the breeding-grounds and vagrants have been recorded in Denmark, Holland, Belgium and Spain.

This is the smallest European owl, little larger than a Bullfinch (*Pyrrhula pyrrhula*), but in spite of its small size it is a true owl in every respect. The compact, plump body form and the "neckless" head with forward-looking yellow eyes are distinctive and separate

the bird, when perched, from Passerines of similar size. When excited this species jerks its tail sideways as a Red-backed Shrike (*Lanius collurio*) does (plate 14), and it can also raise it upwards; indeed, after alighting in a tree it usually cocks it up in the manner of a Wren (*Troglodytes troglodytes*). The flight is rapid, undulating and woodpecker-like, with a silhouette that is a miniature of the Little Owl's (*Athene noctua*), though at certain angles it resembles a Skylark (*Alauda arvensis*) but with longer and broader wings. The Pygmy Owl is mainly a diurnal species, though it is most active at dawn and dusk.

Plates 13, 14 and 16 between them give a good indication of the adult's plumage. It has dark brown upper-parts, spotted with greyish-buff (plates 13 and 14); and brownish-white under-parts, streaked with blackish (plate 16). The face is brownish-white, and the yellow eyes and bill are often, but not always, set off by whitish eye-brows; in this connection one should compare the conspicuous eye-brows of the winter bird on plate 13 with the face of the nesting one on plate 16, where this feature is almost completely lacking. Possibly this difference is the result of some stage of moult, rather than of individual variation, but these plates do illustrate the fact that the "eye-brows" are not always a reliable field-character. The tail is brown, barred with white, and the legs are covered with whitish-grey feathers.

In spring and summer the Pygmy Owl lives in coniferous or mixed forests in both mountainous and lowland areas, but in winter it may sometimes be found in other habitats and may even come to the parks and gardens close to human habitation, occasionally occurring in villages and towns. In Sweden, where these photographs were taken (in Hälsingland), egg-laying begins in April or May, sometimes even at the end of March. Between 3 and 7 (sometimes 8) whitish eggs are laid in a hollow in a tree, usually a woodpecker hole (as shown in plates 14-16). The female alone incubates, starting with the third egg, and the period is 28 days (S. Bergman, *Djur*, Stockholm 1944). Fledging also takes 28 days, and the young shown on plate 15 are probably about this age; their plumage is then dark brownish.

Plate 13 is a remarkable study of a Pygmy Owl that has just caught a wood mouse (*Apodemus* sp.) in the snow, and a comparison of the sizes of prey and predator serves to lay emphasis on the smallness of this bird. Unlike some other owls which feed almost exclusively on rodents, this species has quite a catholic taste and so the population in Scandinavia, although fluctuating periodically to a certain extent, does not rise and fall so distinctly with the numbers of the small mammals. Indeed, not only voles, mice and shrews, but also small birds, lizards and insects, go to make up the food of the Pygmy Owl. Of the birds, tits (*Parus* spp.), for example, are usually caught when they are asleep, but birds as well as insects may also be taken in flight.

This owl often eats its prey in the nest-hole, and in autumn and

winter there is a tendency for holes to be used to store large quantities of food. This means that good samples of food-remains may fairly easily be collected. Norwegian investigations into the food of this species in winter, compiled by Yngvar Hagen (*Rovfuglene og Viltpleien*, Oslo 1952), showed that of 416 vertebrate animals found in the material collected 154 were rodents, 131 shrews, and 131 birds. The largest bird that seemed to have been killed by a Pygmy Owl was a Great Spotted Woodpecker (*Dendrocopos major*).

The Pygmy Owl's most usual sound is a characteristic whistling, very Bullfinch-like and heard in the evenings of autumn and winter. During the mating time, on spring evenings, these soft, fluty calls—*hew, hew, hew*—are produced in series with remarkable steadiness to form a "song" that has an interval of two seconds between each note. The sound seems to be rising and falling, because the owl turns its head in different directions as it calls; during the song, too, the tail is usually moved. This song may sometimes be heard in January or February, but in general, it is not started before March. Sometimes the female answers the male and the two birds give long duet performances. The vocal activity starts at dusk, contributing to the concert of thrushes (*Turdus* spp.) and Robins (*Erithacus rubecula*), and it continues with much energy until darkness falls; then it is the turn of the nocturnal Tengmalm's Owl (*Aegolius funereus*), which is often found in the same habitat as its smaller relative. At dawn the Pygmy Owl takes over again, sounding for all the world like a chiming clock.

Other calls of this species are piping or moaning notes, *zvee-zvee-zvee*, and a twittering *keerr*. During autumn afternoons, as dusk falls, one may occasionally hear a swift, successively shriller tone with rising pitch, too difficult to interpret with letters. There is also a sound resembling the common *ke-wick* of the Tawny Owl (*Strix aluco*).

## REPORTS FROM BRITAIN OF BLACK-HEADED GULLS RINGED IN THE OBERLAUSITZ, EAST GERMANY

By WOLFGANG MAKATSCH

"LARGE NUMBERS of ringed Black-headed Gulls (*Larus ridibundus*) are reported in Britain each winter, the places of origin being chiefly the countries of northern Europe, with a not inconsiderable number from Czecho-Slovakia, Saxony and Bavaria" (Leach, 1956). In view of this statement, it is of interest to consider the British and other recoveries of Black-headed Gulls ringed by us as young birds, not yet able to fly, in the colonies at Wessel and Spreer Heidehaus in the Oberlausitz, East Germany. These

colonies are respectively about  $9\frac{1}{2}$  miles north and 25 miles north-east of Bautzen. Ringing and recoveries up to and including 1951 were recorded in my book on this species (Makatsch, 1952) and it will suffice to repeat here that at that date 106 recoveries had been notified from various countries; from 1952 to 1956 another 1,426 Black-headed Gulls were marked (with Radolfzell Bird Observatory rings, as before), and during this period a further 74 recoveries were reported.

These results show that our Oberlausitz gulls winter chiefly in west and south-west Europe. Reports have been received from the North Sea, English Channel and Atlantic coasts—i.e. north-west Germany, the Netherlands, Belgium, England, France and as far as north and south-west Spain—and further notifications have come in from east Spain, the Balearic Islands and the French Mediterranean coast, as well as from north and central Italy. The Oberlausitz Black-headed Gulls, like those from other parts of Europe, also seek out the Swiss lakes as winter-quarters.

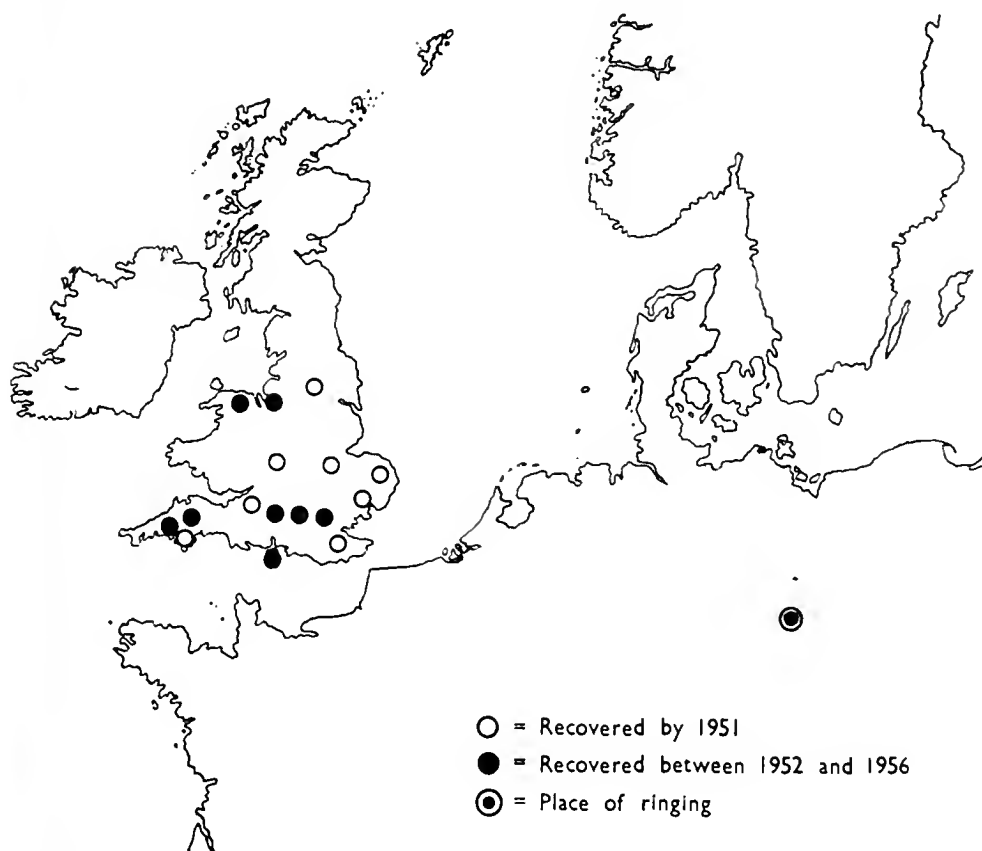

MAP 1—RECOVERIES IN BRITAIN OF BLACK-HEADED GULLS (*Larus ridibundus*) RINGED IN THE OBERLAUSITZ, EAST GERMANY

This then is the general picture that has emerged from our work, and we can now consider in greater detail the recoveries from Britain. Out of the 106 reports received by 1952, eight

came from England; and out of the 74 reports received from 1952 to 1956, a further eight were from England; which gives us a total of 16 from 180 recoveries. The distribution of these is shown on Map 1, from which it can be seen that it is primarily southern England that is concerned.\* The northermost recovery came from Carlton Main Colliery in Yorkshire. Details of the earlier records were published in my book, already mentioned (Makatsch, 1952). The recoveries since that time, those received between 1952 and 1956, are listed in Table I; they have reached me through the kind offices of the Bird-Ringing Committee of the British Trust for Ornithology and the Radolfzell Bird Observatory.

TABLE I—RECOVERIES IN BRITAIN, DURING 1952-56, OF BLACK-HEADED GULLS (*Larus ridibundus*) RINGED IN THE OBERLAUSITZ, EAST GERMANY

*Radolfzell*

Ring No.	Ringling data	Recovery data
E 13715	31.5.52 Wessel	24.5.56 Golant, near Fowey, Cornwall
E 13866	1.6.52 Wessel	27.1.53 Kingsgate, Kent
E 13998	16.6.52 Wessel	31.3.55 Rainham, Kent
E 14011	16.6.52 Wessel	7.8.52 Lerryn, near Fowey, Cornwall
E 15979	24.5.53 Wessel	10.1.56 Neston, Cheshire
E 16063	26.5.53 Wessel	mid-Feb. 1954 Bembridge, Isle of Wight
E 20672	11.6.55 Wessel	17.9.55 Hershham, Surrey
E 20705	11.6.55 Wessel	6.10.56 Weston, near Runcorn, Cheshire

With the exception of the first of these, all were reported as "found dead".

The first of the records detailed in Table I is interesting in that the bird was recovered during the breeding-season, which suggests that Oberlausitz birds will sometimes completely forsake their place of birth. Another record of this kind was of a bird ringed on 10th July 1951 (E 9061) in the colony at Spreer Heidehaus and recovered in the nesting-season three years later, on 5th June 1954, one and a quarter miles west of Lindesberg in Sweden, some 560 miles north of where it was ringed.

In conclusion, I would like to itemize several non-British recoveries that are of special interest, either because they do not fall into the general pattern of movement discussed at the beginning of this short paper or, in two cases, because of the manner of their recovery. Three Black-headed Gulls were found wintering to the south of the normal limits of our birds: one of these, ringed at Wessel on 11th June 1955 (E 20796), was recorded on 4th February 1956 at Corleo, near Marsala, Sicily; the other two, ringed at Wessel on 31st May 1952 (E 13658) and 26th May 1953 (E 16072), were reported from Morocco—respectively at Port d'Agadir in January 1953 and at Safi in the winter of 1953-54 (exact date unknown). The last of these was reported as having been killed by hail, and this prompts me to mention two other cases of birds that died in unusual circumstances. One, ringed at Wessel on 5th June 1954 (E 16274), was struck by a subsiding clod of earth, on 15th January 1957, while searching for food in a furrow of a ploughed field near

\*The map is as supplied by the author and indicates only very roughly the positions of the recovery localities. Readers should rely on the text.—Eds.

Kaiserswerth (5 miles north of Düsseldorf); the other, marked at Wessel on 5th June 1954 (E 16146), was run over by a car in Hamburg on 31st January 1956.

## REFERENCES

- LEACH, E. P. (1956): "British recoveries of birds ringed abroad". *Brit. Birds*, xlix: 438-452.  
MAKATSCH, W. (1952): *Die Lachmöwe*. Leipzig.

[We showed this short contribution to Mr. R. A. O. Hickling, in view of the enquiries into the inland and coastal roosts of gulls during winter, which he organized on behalf of the British Trust for Ornithology (see *Bird Study*, vol. 1, pp. 129-148). Mr. Hickling commented that in the course of his enquiries it was discovered that enormously greater numbers of gulls pass through the east coast in autumn than winter here. It is assumed that they mostly go on to winter in the Mediterranean area, or at least south of Britain. There is, however, no positive evidence and, as Mr. Hickling remarked, Dr. Makatsch's paper seems possibly to provide something in support of such a theory. It shows that the Oberlausitz gulls winter chiefly in west and south-west Europe; and the 16 British recoveries (which really form quite a useful proportion of the total of 180) could be wintering birds, or they could indicate just such a passage through Britain—especially as, of the eight listed above, three are autumn records and three are spring ones. On the other hand, gulls from near Bautzen would have to travel about 600 miles due west to reach south-east England, and this seems rather a circuitous route to the south-west.—EDS.]

## NOTES

**Leach's Petrels in Shetland.**—On 6th August 1957, Leach's Petrels (*Oceanodroma leucorhoa*) were located over the boulder-strewn slopes of The Noup, Foula, Shetland. One was caught and at the same time two others could be heard calling in flight. One was again calling on the 7th, but on the 9th only the first half of a single call was heard. The moon was then full and with petrel activity at a minimum no indication of a possible breeding area could be found.

None of the present islanders, who all know the Storm Petrel (*Hydrobates pelagicus*) well, has ever seen a Leach's Petrel during the breeding season, although there were unsubstantiated tales of cats having brought petrels with forked tails into the crofts. However, Mr. R. Isbister, of South Biggins, recalled that a similar petrel had been found in a burrow many years ago. Mr. L. S. V. Venables followed up this record and it appears that the late James Isbister, of Breckins, sometime between 1908 and 1912 (extreme dates) found a black and white "storm petrel" with a forked tail sitting on an egg in a hole at Helliberg, on the west side of South Ness, Foula.

Mr. Andrew Gear, a native of Foula, on listening to recordings of the Leach's Petrel, was of the opinion that he had previously heard this sound on The Noup but had assumed that it was probably a call of the Manx Shearwater (*Procellaria puffinus*).

Mr. Venables has also informed me that, after hearing a recent B.B.C. recording of the Leach's Petrel, Mr. Tom Henderson, of Spiggie, Shetland, immediately recognized it as the unknown song which he heard, for one night only, in a Colsay cliff a few summers ago.

D. R. WILSON

**Honey Buzzard in Lancashire.**—On 11th October 1957, I was brought the body of a large hawk which had been picked up dead on a farm not far from Chorley, Lancashire. A day or two later I took the bird into the museum at Bolton where it was identified by Mr. Alfred Hazelwood as a female Honey Buzzard (*Pernis apivorus*). A bird of the year, it was in extremely fat condition and its crop contained a large quantity of insect remains, especially hymenopterous grubs. Autopsy revealed that the bird had been shot. The specimen is now preserved in the Bolton Museum.

The occurrence is particularly noteworthy because the species has not been recorded in Lancashire with certainty since 1852, when a bird was shot at Lostock, about six miles distant from the present locality, also in October (*vide* Clifford Oakes, *The Birds of Lancashire*, 1953).

DAVID REDHEAD

**Spotted Crake in Oxfordshire in July.**—On 17th July 1957, a freshly killed Spotted Crake (*Porzana porzana*) was found on the road at The Views, Great Milton, Oxfordshire, and brought to the Edward Grey Institute by Mrs. Leslie Hobbs. It was thought to have been killed by traffic. The bird was in excellent condition and on dissection was found to be a female with a large ovary. The following evening N. P. Ashmole and I listened at what we considered likely breeding places half a mile and about four miles away, but we heard nothing. The time of the year, general condition of the bird and size of the ovary suggest that the bird had either recently bred or was breeding. The specimen is now in the University Museum, Oxford.

D. F. OWEN

**Spotted Crake in Cheshire in July.**—On 20th July 1957, Mr. David Bates found a dead bird by Thurstaston station, Wirral, Cheshire. He took it to Mr. N. F. Ellison, who identified it as a Spotted Crake (*Porzana porzana*). It is now in the Liverpool Museum, where Mr. R. Wagstaffe reported it to be a male, nearly a year old. It had a broken neck and had presumably been killed by striking a wire.

A. W. BOYD

[We feel that summer records of Spotted Crakes are of particular interest in view of our lack of knowledge of the exact status of this species as a breeding bird in the British Isles.—EDS.]



**Mating display of Snipe.**—At 11.30 a.m. on 10th March 1957, we watched from inside a car, at just over 100 yards' range, the pairing of two Snipe (*Capella gallinago*) in a field below Rostherne church, Cheshire. The display lasted about half an hour, during which time the birds moved to and fro on a compact area of meadow grass, of about 5 yards radius, near a group of well-grown evergreen and deciduous trees about 50 feet up a slope above a brook and a damp meadow. Every movement was clearly visible on the closely-cropped turf, though it rained steadily all the time. When first seen, the male, which was the larger and darker-breasted, was following the much paler-breasted female, always at a distance of a few inches to a maximum of about two feet. The female at this stage occasionally fluttered up to a height of about a foot from the ground and more rarely the male fluttered up in response, but for most of the time he maintained a silent deliberate pursuit on the grass. After a while the female was seen to erect her tail perpendicularly between the almost closed wings and to spread it out fully to form a golden-buff fan. This display gradually became more intense and bouts of fluttering up and down became more frequent, the female usually rising first followed by the male, but sometimes the two simultaneously. Much more rarely the male also erected its tail, or at least made it more conspicuous, but never nearly so erect or fully fanned or for so many seconds as the female. Eventually, after a skirmish, the male attempted to mount the female immediately after she alighted, but this was abortive and the pursuit was resumed for some time. The fluttering then became much more intense and almost continuous, and face to face. As the female descended, the male followed her down closely; at times she alighted and cowered with wings widespread and tail fully fanned but not erect. As the intensity and rapidity of this display grew the male made several attempts at coition immediately the female alighted, at times seeking to bind to her during her descent. Finally coition was achieved on the ground with the female lying flat with outspread wings. Immediately afterwards they flew away together down the slope towards the brook. The "chipper" note was now uttered several times; previously only two very brief snatches of this call had been heard during the otherwise silent pursuit. A Mistle Thrush (*Turdus viscivorus*) and a Song Thrush (*T. philomelos*) were at different times close and interested spectators.

The ground chosen was higher and drier than the Snipe's normal habitat, but the birds during their display never left the small arena at the top of the slope. The initiative seemed to be with the female, whose movements on the ground, upward flutterings and erected tail regulated the male's movements, and it was evident that the immediate signal for coition was the fluttering descent and the subsequent cowering posture of the female.

Previous descriptions of Snipe display which we have consulted

do not appear to refer to these preliminaries in coition for a pair in isolation, out of sight or sound of other individuals.

R. P. Bagnall-Oakeley's sketch (*antea*, vol. xlviii, p. 280) illustrates display in late summer and differs also in the tail's being fanned forward beyond the vertical with the bird in a crouching, not a standing, attitude and in the combination of tail-fanning and springing into the air in a repeated brief sequence. In that case, also, a number of birds participated and the actions were apparently associated with threat rather than courtship.

A. W. BOYD and E. M. NICHOLSON

[Leslie M. Tuck, of the Canadian Wildlife Service, an authority on the American race of this species (*C. g. delicata*)—known there as Wilson's Snipe—has kindly commented as follows on the above note: "I have seen copulation by Wilson's Snipe only three times and on each occasion the pre-copulatory display has been somewhat different. First of all, the matings I have observed took place in very exposed situations—on a mud bank, on a matted weed-bed and on a closely-cropped grass meadow, in that order. This agrees with your observation, but in each instance both of my birds uttered an insistant "cut-a-cut-a-cut-a . . ." through-out the pre-copulatory displays. I have also noted the fluttering which you describe. In my notes I named it the "flutter-leap", but so far I have never seen the act terminate in copulation. However, in each instance, when that type of display was gathering momentum some outside disturbance broke it up. Various forms of display which I have noticed during pre-copulatory activities also occur, in a much less intense or "watered down" version, during the pre- and post-nesting activities. My observations on pre-copulatory behaviour indicate that there is a great deal of strutting, tails erectly-fanned by both sexes, and, when a second male is involved, sparring and leap-frogging. Copulation took place with the female remaining motionless in a crouch, wings extended and tail widely fanned".—A.W.B. and E.M.N.]

**White-rumped Sandpiper in Yorkshire.**—On 19th October 1957, while staying at Spurn Bird Observatory, Yorkshire, we picked up a dead wader on the road about 250 yards from Warren Cottage. It was lying beneath overhead wires and had a neck injury which suggested that it had hit these. It had a white rump, but it was smaller than a Dunlin (*Calidris alpina*) and had a noticeably short tarsus and a short, straight bill. On these and other features the bird was identified as a White-rumped Sandpiper (*C. fuscicollis*), the first record for Yorkshire. It was also examined by J. A. S. Borrett, Ralph Chislett, B. Potter, S. J. Weston, G. R. Wilkinson, D. R. Wilson and several other observers. A full description was entered in the Spurn Observatory log, and a copy of this has been sent to the Editors of *British Birds* together with three photographs taken by J. A. S. Borrett.

The skin is now preserved in the Bolton Museum, Lancashire, where Alfred Hazelwood confirmed the identity and found it to be a young female.

J. R. MATHER and R. F. DICKENS

**The field-identification of Baird's and Semi-palmated Sandpipers.**—In their note on this subject (*antea*, vol. L, pp. 350-351), Messrs. K. Williamson and H. G. Alexander suggest that the most valuable field-character for distinguishing these two species may be the "horizontal" appearance of the Baird's Sandpiper (*Calidris bairdii*) compared with the "upright" stance of the Semi-palmated (*C. pusilla*). They analyse this difference as follows:

- (1) in the Baird's, the wings overlap the tail end, but in the Semi-palmated they do not;
- (2) the Baird's has legs proportionally shorter than the Dunlin (*C. alpina*), whereas those of the Semi-palmated are proportionally longer.

During the last few months, I have watched many Semi-palmated Sandpipers and three Baird's in Canada. Identification has been confirmed with specimens of both. I have seen Baird's and Semi-palmated together, but neither side-by-side with a Dunlin, for this is a later migrant here. Since reading the note, I have seen no more Baird's, but have examined Semi-palmated Sandpipers whenever possible to check on the first of the two points above, i.e. that the wings do not project beyond the tail. It does not always hold. Of fourteen, about eight had wing-tips projecting slightly beyond the tail, while the others had wing-tips equal to or slightly shorter than the tail.

The points I have found most helpful for the field-identification of Baird's have been:

- (1) upper-parts far more scaly, especially on scapulars, than in a juvenile Semi-palmated Sandpiper. There is no mistaking the difference when one has become acquainted with the Baird's;
- (2) buff, well streaked with brown, extends in a band across the upper breast and up the sides of the neck to the cheeks in the Baird's;
- (3) the bill of the Baird's is slender, that of the Semi-palmated is short and stout.

P. W. P. BROWNE

**Ruffs displaying in a wintering area.**—Around 15.00 hours on 8th February 1956 I came upon a group of waders on a settling bed of the Cambridge Sewage Farm. The group included two Green Sandpipers (*Tringa ochropus*), thirteen Dunlins (*Calidris alpina*) and twenty-two Ruffs (*Philomachus pugnax*). The weather was dull, the cloud-base low and a fine drizzle was falling. This state of the weather made me all the more surprised when I realised that there was something more than normal behaviour apparent in the Ruffs' actions. Making notes and field-sketches from 15.15 to 15.30 hours, I was able to compile a summary of these. Of the twenty-two Ruffs twenty were males, distinguish-

able from the two Reeves by their larger size and more definitely patterned backs. Five of the males were "white-headed"—that is, with a marked area of white on the chin, throat, lower face and neck—and these stood out among the rest. They seemed to be the most active, two especially being continually aggressive. The remainder were less active, reacting to the "advances" of the "white-heads", but apparently needing this stimulus before displaying. The Reeves appeared to take no part in the display and none of the males showed the slightest suggestion of a ruff.

As a whole, the display could be divided into three main actions: (1) *A rapid chasing off* of one bird by another, generally with a "white-head" as the chaser, starting from positions of rest or feeding, or from the next two actions to be described (seen on twelve occasions in the quarter-hour of observation). (2) *Posturing* between pairs of males, with bodies depressed and tail up, head and neck held low and bill pointing upwards. This was accompanied by pivoting on the legs and a "bucking" movement from the shoulders (seen on six occasions). (3) *Sparring in the air* just off the ground, by two couples of birds only, following posturing, and with the birds apparently "boxing" with their feet (seen on three occasions, twice from one couple of "white-heads"). In addition odd birds would indulge in low flights over the group, ending by landing and usually displaying immediately at another. At 15.30 hours I tried to approach closer, but when I got to within about 40 yards the birds ceased to display. Before then they had taken no notice of me, so engaged were they in their own doings, even when the Dunlins and Green Sandpipers departed in alarm at my bolt-upright approach. The display appeared substantially identical in actions to the "jousting" that I have seen among breeding birds in Holland in spring and which has also been recorded among late migrants at that season at Cambridge. In two winters of watching Ruffs at Cambridge, however, I have been struck with the tolerance shown between individuals making up the flocks, and I do not believe that the display was in any way founded on breaches of the individual distance imputed to each bird in a flock. None of the other regular observers at the Cambridge Sewage Farm has seen any similar behaviour in winter, nor can I find any reference to a previous record. Finally it is of interest to note that from August 1953 to February 1954, during which period I was regularly watching large numbers of passage and wintering Ruffs in the area of Lake Nakuru, Kenya Colony, I never saw any similar behaviour.

D. I. M. WALLACE

**Rooks taking sand.**—On the evening of 11th September 1957, I was on the beach at Portsalon, Co. Donegal. Rooks (*Corvus frugilegus*) were coming in to roost in a small wood about a quarter of a mile inland. They first flew to the trees, then about 50 or so came and dropped down on to the beach, and each of these took one, or sometimes two, beakfuls of sand, which they swallowed. A few then flew to pools of seawater in some rocks,

and bathed and preened. About 3 minutes later they all left again for the roost. After they had gone, the spot where they had been was marked with deep slits in the sand where they had dug their bills in. Presumably the sand was taken in place of grit.

SUSAN COWDY

**Willow Warbler's unusual song and display-flight.**—Sir Julian Huxley's description (*antea*, vol. xlix, p. 154) of an abnormal song uttered by a Willow Warbler (*Phylloscopus trochilus*) at Dartford, Kent, reminds me in many ways of a song that I heard from a bird of this species in a wood at Combe Down, near Bath, Somerset, on 24th April 1954. This began normally, then quickly trailed off into a mixture of sweet and harsh notes which similarly seemed to me to have something of the quality of the song of the Linnet (*Carduelis cannabina*). It differed from the one heard by Huxley, however, in that it was closely associated with an interesting display-flight. When first seen, the bird was singing normally from a silver birch sapling, but it soon took flight and, with rapidly beating wings, circled slowly round before returning to its original perch; it was while circling in this way that it produced the mixture of notes already described. I was not able to watch the bird for long, but this song-flight display was repeated at least six times before I left.

The only record which I can trace of sustained song and display-flight in the Willow Warbler is the one by R. H. Dunt (*antea*, vol. xxxix, p. 25).

BERNARD KING

## REVIEW

ORNAMENTAL WATERFOWL. A Guide to their Care and Breeding. By LT.-COL. A. A. JOHNSON and W. H. PAYN. 96 pages; coloured frontispiece by Roland Green; 12 photographic plates. (*Witherby*, London, 1957). 21s.

INTENDED to provide detailed practical information for keepers, and would-be keepers, of waterfowl, this small book fulfils its aims admirably. A work of this kind was badly needed, for many improvements in technique have been achieved by the growing band of enthusiasts in the fifty years since the appearance of Miss Rose Hubbard's similarly-titled book.

The authors have concentrated on the needs of people with limited space and show how inexpensive equipment, requiring little skill to construct and maintain, can provide healthy living and breeding conditions for most types of waterfowl. It might have been useful to have given some indication of the price of hand-reared birds. For example, ten species of ducks are listed as "more attractive and less expensive" and "particularly suitable for beginners". Current prices for these species range from six to twelve pounds a pair, so that a collection of one pair of each would probably cost about eighty pounds. Geese, with a very few exceptions, are more expensive. Of course, once a collection is successfully established, it may be possible to recoup most of the

outlay on the initial stock by the sale or exchange of surplus young birds reared.

Another source of expense for which estimates would be instructive is the purchase of grain and, particularly, of the proprietary poultry or game-bird foods which are, rightly, recommended for breeding birds and ducklings. It may easily cost three pounds to raise a duckling to maturity.

Perhaps the weakest chapter in the book is that devoted to diseases. This is by no means wholly the authors' fault since, despite recent important advances in chemotherapy, all too often symptoms appear too late for effective medication, or no treatment has yet been found reliable. But several comparatively frequently found troubles are not mentioned (e.g. aspergillosis, gape-worms, nephritis and *Acuaria*-infection) and it would have been better to mention some places and people competent to carry out post-mortems and advise on preventive measures. Veterinary Investigation Centres of the Ministry of Agriculture provide a valuable service in this field.

These are small criticisms. If you must keep waterfowl, this is a book you ought to have.

H.B.

## RECENT REPORTS AND NEWS

By I. J. FERGUSON-LEES

**The items here are largely unchecked reports, and must not be regarded as authenticated records. They are selected, on the present writer's judgment alone, from sources generally found to be reliable. Observers' names are usually omitted in case a report is subsequently rejected, and none of the items will be mentioned in our annual Index. Readers are asked to submit anything of interest as quickly as possible.**

January does not usually provide many real rarities, and on this occasion there are only two new reports of such very uncommon species: a male Desert Wheatear (*Oenanthe deserti*) on the Essex coast on 12th-13th January and 3rd February, and an adult Lesser White-fronted Goose (*Anser erythropus*) in Kirkcudbrightshire between 17th and 19th January and on 1st February. The latter was at the same locality that has produced Lesser Whitefronts in several previous years (*antea*, vol. xlix, p. 227), but by the end of January none had been seen at the other regular area—the New Grounds in Gloucestershire. The immature White-tailed Eagle (*Haliaëtus albicilla*) which was mentioned last month as having been reported from Cley, Norfolk, was noted there again on 9th, 12th, 15th and 26th January.

To the reports of Long-tailed Ducks (*Clangula hyemalis*) inland, also discussed last month, may be added an instance of two on Lake Windermere, Westmorland. There was apparently a further small influx of Waxwings (*Bombycilla garrulus*) into East Anglia about the second and third weeks of January, when several were also noted in more westerly localities, including Oxfordshire and Bedfordshire. Bewick's Swans (*Cygnus columbianus bewickii*), which now winter regularly in large numbers on the Ouse Washes in Cambridgeshire and Norfolk, and at Earith in Huntingdonshire, have again built up sizeable herds there after the first parties had arrived rather sooner than usual, in December and early January, and by the beginning of February there were thought to be some 250 in the area.

There may be unusual numbers of Shags (*Phalacrocorax aristotelis*) inland. On the evening of 24th January an estimated total of 20-30 "Shags or Cormorants" came down to roost on Shillington church, Bedfordshire: one captured in the graveyard and another photographed were certainly both Shags. Soon afterwards three Shags, and later another two, were reported from Huntingdonshire, two from Hertfordshire and one from Buckinghamshire.

## NOTICE TO CONTRIBUTORS

*British Birds* publishes material dealing with original observations on the birds of Britain and Western Europe, or, where appropriate, on birds of this area as observed in other parts of their range. Except for records of rarities, Papers and Notes are normally accepted only on condition that the material is not being offered to any other journal. Photographs (glossy prints showing good contrast) and sketches are welcomed. Proofs of all contributions accepted are sent to authors before publication. After publication 20 separates of Papers are sent free to authors; additional copies, for which a charge is made, can be provided if ordered when the proofs are returned.

Contributors are asked to observe the following points, attention to which saves the waste of much editorial time on trivial alterations:

1. Papers should be typewritten with double spacing, and on one side of the sheet only. Shorter contributions, if not typed, must be clearly written and with similar spacing. Failure to help in this way may result in delays to publication.

2. Notes should be worded as concisely as possible, and drawn up in the form in which they will be printed, with signature in block capitals and the writer's address clearly written on the same sheet. If more than one Note is submitted, each should be on a separate sheet, with signature and address repeated. In the case of rarity records, any supporting description which is too detailed for publication should be attached separately.

3. Certain conventions of style and lay-out are essential to preserve the uniformity of any publication. Authors of Papers in particular, especially of those containing Systematic Lists, Reference Lists, Tables, etc., should consult the ones in this issue as a guide to general presentation. English names of species should have capital initials for each word, except after a hyphen (e.g. Siberian Thrush, Yellow-headed Wagtail), but group terms should not (e.g. thrushes, wagtails). English names are those used in *The Handbook of British Birds*, with the exception of the changes listed in *British Birds* in 1953 (vol. xlvii, pp. 2-3). The scientific name of each species should be given (in brackets and underlined) immediately after the first mention of the English name. Sub-specific names should not be used except where they are relevant to the discussion. It is sometimes more convenient to list scientific names in an appendix. Dates should take the form "1st January 1955" and no other, except in Tables where they may be abbreviated to "1st Jan.", "Jan. 1st", or even "Jan. 1", whichever most suits the lay-out of the Table concerned. It is particularly requested that authors should pay attention to Reference Lists, which otherwise cause much unnecessary work. These should take the following form:

TUCKER, B. W. (1949): "Species and subspecies: a review for general ornithologists". *Brit. Birds*, xlii: 129-134.

WITHERBY, H. F. (1894): *Forest Birds: Their Haunts and Habits*. London. p. 34.

Various other conventions concerning references, including their use in the text, should be noted by consulting previous examples.

4. Tables should be numbered with Roman numerals, and the title typed above in the style used in this issue. The title and any headings within the Table should not be underlined, because this sometimes makes it difficult for the Editor to indicate the type to be used. It is most important that the lay-out of each Table should be carefully planned with an eye to its final appearance; above all, it should be borne in mind that Tables must either fit into the width of a page, or be designed to fit a whole page lengthways. All Tables should be self-explanatory.

5. Figures should be numbered with Arabic numerals, and the captions typed on a separate sheet. All line-drawings should be in Indian ink on good quality drawing paper (not of an absorbent nature) or, where necessary, on graph paper, but this must be light blue or very pale grey. It is best if maps, graphs, etc., are drawn twice the size of the final reproduction (ideally, therefore, for the normal 4" width the original should be 8" wide); sketches of birds, however, should be only slightly larger than the size at which it is intended they should appear. It is always most important to consider how each drawing will fit into the page. The neat insertion of lettering, numbers, arrows, etc., is perhaps the most difficult part of Indian ink drawing and, unless he has had considerable experience of this kind of work, an author should seek the aid of a skilled draughtsman. The publishers regret that, owing to rising costs, it will in future be only in exceptional cases that they can undertake to have lettering inserted.



# SS 12x60

BLOOMED LENSES

**meopta**

In 1939 Czechoslovakia was renowned for precision engineering and the Meopta Company

of Prague had established a world reputation for precision optical instruments. The outbreak of the Second World War brought the disruption of international trade and subsequently the Meopta products became completely absorbed by the German Armed Forces. Since the end of hostilities, only one small quota of Meopta binoculars has been sanctioned for the United Kingdom.

**THIS IS THE ONLY IMPORTATION OF CZECHOSLOVAKIAN BINOCULARS TO ENTER BRITAIN SINCE 1939.**

The construction of a binocular with a 60 mm. object lens presents technical difficulties not encountered in the production of the smaller types and the normal price is about £70.

The Meopta 12 × 60 has the rare combination of high magnification and brilliant light gathering power, even at night and under bad climatic conditions. The superb optical performance is an outstanding achievement in binocular construction.

The price, including the leather case and lanyard, is £31 10s. 0d. There is no comparable value in the Western World.

Sole distributor in the United Kingdom,

**THOMAS PARRY**

52, KNIFESMITH GATE, CHESTERFIELD

Telephone 4906

*Cheque or Money Order crossed, payable THOMAS PARRY, should accompany your name and address, BLOCK LETTERS PLEASE. Binoculars cannot be sent on approval, but satisfaction or full cash refund guaranteed. Personal callers welcomed.*



# BRITISH BIRDS



MARCH 1958

THREE SHILLINGS

# BRITISH BIRDS

AN ILLUSTRATED MONTHLY MAGAZINE

Edited by

E. M. NICHOLSON

W. B. ALEXANDER

A. W. BOYD

I. J. FERGUSON-LEES

P. A. D. HOLLAM

N. F. TICEHURST

*Editorial Address* : 30, St. Leonard's Avenue, Bedford.

*Photographic Editor*: G. K. YEATES

Annual Subscription £2 (including postage and despatch)

payable to H. F. & G. Witherby Ltd., 5, Warwick Court, London, W.C.1

---

---

## CONTENTS OF VOLUME LI, NUMBER 3, MARCH 1958

	PAGE
The migrations of British hawks (Accipitridae) as shown by ringing results. By Sir A. Landsborough Thomson, C.B., D.Sc. ... ..	85
A North Atlantic transect in September. By P. W. P. Browne ... ..	93
Photographic studies of some less familiar birds. LXXXVI—Chough and Alpine Chough. Photographed by Dr. Richard Vaughan and Harold Platt (plates 21-24). Text by I. J. Ferguson-Lees ... ..	99
The birds of Tiree and Coll. By Dr. J. Morton Boyd. ( <i>Concluded from page 56</i> ) ... ..	103
Notes:—	
Glossy Ibis in Dorset (Arthur Bull) ... ..	118
Pratincole in Hampshire (J. K. Bowers and E. L. Jones) ... ..	119
Black-winged Pratincole in Somerset (John Reynolds) ... ..	119
Pratincole or Black-winged Pratincole in Sussex (J. W. Donovan) ... ..	120
Great Skua harrying Shelduck (R. Angles) ... ..	121
Black Terns feeding on mud-worms (Trevor Silcocks) ... ..	121
Apparent coition between House Martin and Sand Martin (Bernard King) ... ..	121
Hoarding of food by Willow Tit (David Hart) ... ..	122
Hoarding of food by Coal Tit (David Hart) ... ..	122
Abnormal Dipper breeding in North Wales (L. S. V. and U. M. Venables) ... ..	124
Reed Warbler in Co. Down (L. S. V. and U. M. Venables) ... ..	124
Reed Warblers in Anglesey (W. Mulligan and L. S. V. Venables) ... ..	124
Greenish Warbler in Kent (H. E. Axell) ... ..	125
Observations on a Corn Bunting roost in reeds (J. H. Taverner) ... ..	126
Review:—	
<i>The Mute Swan in England</i> . By N. F. Ticehurst ... ..	127
Letters:—	
Information wanted on Lapwing chicks (P. A. Rayfield) ... ..	128
"Science and the bird-watcher" (Capt. A. M. Macfarlane; G. L. Boyle) ... ..	129
Requests for Information:—	
The 1957 irruptions of tits and other species (A. Pettet, J. T. R. Sharrock and Stanley Cramp) ... ..	130
Gulls feeding on grain (T. A. W. Davis) ... ..	130
The place of birds in English folklore (Department of English, University College, London) ... ..	130
Recent reports and news. By I. J. Ferguson-Lees ... ..	131

---

Cover photograph by Harold Platt; Chough (*Pyrhcorax pyrhcorax*) in flight (see pages 99-103)



## BRITISH BIRDS

### THE MIGRATIONS OF BRITISH HAWKS (Accipitridae) AS SHOWN BY RINGING RESULTS\*

By A. LANDBOROUGH THOMSON

THE PURPOSE of this paper is to analyse the recovery records of species of the Accipitridae (including Accipitrinae, Buteoninae, Circinae and Pandioninae) ringed in the British Isles under the scheme now managed by the Bird-Ringing Committee of the British Trust for Ornithology and earlier by the late H. F. Witherby, then Editor of *British Birds*. There were no recoveries for any of these species under the former Aberdeen University scheme. A further paper will deal with the falcons (Falconidae).

The numbers of each species ringed and recovered under the scheme are:—

	<i>Ringed</i> to 31.12.56	<i>Recovered</i> to 31.12.57	<i>Percentage</i> <i>recovered</i>
Golden Eagle ... ..	20	1	—
Buzzard ... ..	844	44	5.2
Sparrowhawk ... ..	1,254	(200) 198	15.8
Marsh Harrier ... ..	96	(10) 8	8.3
Hen Harrier ... ..	271	43	15.9
Montagu's Harrier ... ..	201	(26) 24	11.9

(The recovery figures shown in brackets are those counted before excluding certain records as non-viable, for reasons given later; the reduced totals are used in calculating the percentages.)

Recoveries in the British Isles of birds ringed abroad are cited, in the sections which follow, in respect of the species mentioned above and also of the Rough-legged Buzzard and the Osprey. Details have been published in the periodical lists in *British Birds*

\*A publication of the British Trust for Ornithology, the Bird-Ringing Committee of which is indebted to the British Museum (Natural History) for accommodation and ring address and to the Nature Conservancy for financial support.

compiled at first by H. F. Witherby and E. P. Leach, and latterly by E. P. Leach alone.

### Golden Eagle (*Aquila chrysaetos*)

There is a single record—of a bird ringed as a nestling in May at an unspecified locality in Galloway, S.W. Scotland, and caught in a crow trap ("to be released") in the same month the next year at a distance of perhaps 50 miles in a north-easterly direction.

### Buzzard (*Buteo buteo*)

Of the 44 records, one refers to a bird trapped as an adult and recovered locally. The other 43 refer to birds ringed as nestlings in different parts of Great Britain: the analysis is restricted to these.

#### *Recoveries of birds ringed as nestlings.*

As regards season and age, 35 recoveries fell in the first year of life—15 of these in September-November. The remaining 8 recoveries are scattered through the next three and a half years, the oldest bird being in its fifth autumn.

As regards movement, 34 recoveries were quite local; and 9 are from distances of more than 25 miles from the respective places of ringing, as follows:—

<i>Recovery date</i>	<i>Displacement (approx., in miles)</i>
First year:	
August ... ..	Somerset—Oxfordshire (70 N.E.)
October ... ..	Westmorland—Yorkshire (35 S.E.)
„ ... ..	Cumberland—East Lothian (95 N.)
„ ... ..	Inverness-shire—Argyll (34 S.E.)
November ... ..	Devon—Cornwall (57 W.S.W.)
December ... ..	Within Yorkshire (66 E.N.E.)
Second year:	
April ... ..	Bute—Dumfriesshire (65 S.S.E.)
June ... ..	Cumberland—Westmorland (37 E.)
October ... ..	Cumberland—Yorkshire (37 S.)

The directions seem to be fortuitous, and the greatest distance covered is 95 miles. That the majority of the records fall in the first autumn merely reflects the incidence of the series as a whole, and the birds recovered in their second year may or may not have moved earlier.

### Rough-legged Buzzard (*Buteo lagopus*)

#### *British recovery of bird ringed abroad.*

One ringed in Jämtland, Sweden, as a nestling was recovered in Inverness-shire in its first winter.

### Sparrowhawk (*Accipiter nisus*)

After excluding two nestlings which had never flown, there are 198 recoveries; of these, 158 are of birds which were ringed as

nestlings in various parts of the British Isles; and 40 are of birds ringed as full-grown, in many instances apparently on migration.

*Recoveries of birds ringed as nestlings.*

The incidence of the 158 recoveries by season and age, years of life being reckoned from 1st April, is shown in the following table:—

Month	Years of life							Total
	First	Second	Third	Fourth	Fifth	Sixth	Seventh	
April		9	3	1			1	14
May		8	3	1				12
June		7	3		1			11
July	2	6	2	1		1		12
August	16	1	1		1			19
September	13							13
October	8				1			9
November	10		1					11
December	15	3	1					19
January	8	3	1					12
February	7	1						8
March	10		2					12
Uncertain	3	1	1	1				6
Total	92	39	18	4	3	1	1	158

The age distribution falls away in the familiar manner. The high mortality in the first autumn is also as would be expected. On the other hand, the preponderance of summer records in subsequent years is unusual and reflects the amount of shooting of this species during the months when game-birds are breeding: evidence on this point will be given in another publication. All three members of a Somerset brood were shot locally in their natal summer.

With 5 exceptions, all the recoveries can be described as local: the distance from place of ringing rarely exceeded 20 miles and in the majority of instances was under 10 miles; the oldest bird, nearly eight years of age, was only four miles from its place of birth. The recoveries at somewhat greater distances are:—

Recovery date	Displacement (approx., in miles)		
First year:			
September ... ..	Caernarvonshire—	Merioneth (37	S.S.E.)
November ... ..	Surrey—Kent (58		S.E.)
February ... ..	Surrey—Northamptonshire	(95	N.N.W.)
Third year:			
March ... ..	Surrey—Kent (45		E.S.E.)
Fifth year:			
June ... ..	Within Kent (35		E.)

The last of these birds was a female on its nest: a local recovery (Surrey—Sussex, 15 miles S.) in June of the third year was also of a bird shot at the nest.

*Recoveries of birds ringed when full-grown.*

Of the 40 recoveries, 9 were local in the same year and mostly of little interest; 15 others were local at later dates (one after nearly five years) but cannot be interpreted with certainty in the absence of information about the origin of the bird—they may have been sedentary local birds or migrants passing again at the same spot.

It is clearly rash to assume that a bird was necessarily on migration just because it was caught for ringing at a bird observatory or the like in autumn or spring. This remark applies to five birds believed to be on migration when ringed in autumn at Belmullet, Co. Mayo, Eire, and recaptured in the same roost a year later (in one instance also in the third autumn, and in another also in the fourth); likewise to a bird ringed at Spurn Point, Yorkshire, on 25th October and recovered there on 26th September two years later. A bird ringed on Skokholm, off Pembrokeshire, on 27th March was found dead there on 3rd August of the same year; and one ringed on Bardsey Island, Caernarvonshire, on 2nd April was killed on the mainland 12 miles away on 8th May of the same year. There are also local summer recoveries of birds ringed respectively at Spurn Point and on the Saltee Islands, Co. Wexford, Eire, which might originally have been presumed to be migrants.

There remain 16 records showing substantial movement. In view of the sedentary status of British native birds, as shown under the preceding heading, those in question may be safely presumed to have been migrants of foreign origin, although only in two cases is there any more precise indication. The particulars are as follows:—

		<i>Ringing data</i>			<i>Recovery data</i>
juv. ♂	17.9.51	Fair Isle	21.10.51	Vendée, France	
juv. ♀	2.9.53	"	20.11.53	Zuid Holland	
juv. ♂	18.9.53	"	ca. 3.12.53	Aberdeenshire (160 miles S.)	
juv. ♂	14.9.55	"	26.12.55	Mayenne, France	
juv. ♀	9.10.55	"	29.12.55	Nairnshire (162 miles S.S.W.)	
juv. ♀	5.10.55	"	18.1.56	Angus (ca. 200 miles S.)	
juv. ♀	9.11.55	"	3.4.56	Heligoland, Germany	
juv. ♀	6.9.51	"	late 8.52	Lincolnshire (440 miles S.S.E.)	
ad. ♀	8.9.55	Spurn Point, Yorks	(3.10.55)	Essex (115 miles S.S.E.)	
ad. ♀	6.11.50	Gibraltar Point, Lincs.	30.6.52	Valdres, S. Norway	
juv. ♀	16.9.49	"	14.7.51	Valdres, S. Norway	
juv. ♀	29.10.52	"	autumn 55	nr. Antwerp, Belgium	
juv. ♀	24.9.51	Belmullet, Co. Mayo, Eire	28.10.51	Shannon Airport, Co. Clare, Eire (70 miles S.S.E.)	
ad. ♂	10.3.45	Oban, Argyll	2.5.45	Kingussie, Inverness-shire (72 miles N.E.)	
juv. ♂	10.4.51	Gibraltar Point, Lincs.	1.4.52	Holstebro, Jutland, Denmark	
ad. ♂	7.5.56	Dungeness, Kent	14.4.57	Sherborne, Dorset (155 miles W.)	

The chief points of interest in the foregoing list are as follows. Of birds ringed on Fair Isle during autumn migration, one was recovered in Holland and two in France later in the same season, while three others were apparently wintering on the mainland of N.E. Scotland; another was recorded from Heligoland in the following spring. Of birds ringed on the Lincolnshire coast during autumn migration, two were probably native to Norway as suggested by subsequent summer recoveries in Valdres: another, ringed on spring migration, was recovered in Jutland approximately a year later.

*British recoveries of birds ringed abroad.*

There is only one record of a bird ringed as a nestling—in Aust Agder, in the extreme south of Norway; recovered in Hampshire on 23rd September of the same year.

Of birds ringed on autumn migration on Heligoland, 2 were recovered later in the same winter (Kent in January, Flintshire in March) and 3 in subsequent winters (Essex, Kent, Somerset). The oldest bird had carried its ring for nine years.

Of birds ringed in autumn in different parts of Holland, 4 were recovered later in the same winter (Co. Monaghan and Yorkshire in January; Kent and Staffordshire in February), and one in winter two years later (Kent in December).

**Marsh Harrier** (*Circus aeruginosus*)

*Recoveries of birds ringed as nestlings.*

Two records must be rejected—one bird may never have flown, and for the other there are no recovery data beyond the fact that its skin was "seen in a collector's cabinet". There remain 8 valid recoveries, all except the last one below being of birds ringed in Norfolk.

One was recovered in Somme, France, in August of its second year. The leg of another, with ring, was found in April two years later 75 miles east of Casablanca, Morocco. Four were recovered later in the season of ringing in Norfolk (2), in Suffolk (56 miles S.) and in Berkshire (ca. 150 miles S.W.); and a fifth in Lincolnshire (ca. 70 miles W.) in June a year later.

One ringed in a southern English county was found newly dead on 29th December of the same year, within a few miles.

*British recovery of bird ringed abroad.*

One ringed as a nestling in Jylland, Denmark, was recovered in Orkney in April nearly three years later.

**Hen Harrier** (*Circus cyaneus*)

*Recoveries of birds ringed as nestlings.*

Of the 43 recoveries, 39 are of birds ringed in Orkney. Of these, 24 are local recoveries, although not always from the same island of the group; the other 15 are from the mainland of Scot-

land, as follows:— Caithness (4), Sutherland (2), Moray, Banffshire, Aberdeenshire (2), Angus (2), Bute, Roxburghshire and Dumfriesshire—see Map 1. In the last three instances the distance is well over 200 miles, and in five others well over 100 miles.

The earliest record away from Orkney in the first season is for October, and that only from Caithness. In the period November-



MAP 1—MAINLAND RECOVERIES OF HEN HARRIERS (*Circus cyaneus*)

Of 39 recoveries of birds ringed in the Orkney Islands (marked with a circle), 15—mostly in their first winter—were from the mainland localities shown (note the one on the Isle of Bute) and the rest were local, including some in their first winter. The sixteenth recovery on this map—indicated by a connecting line—was of a bird ringed as a nestling in Perthshire (the three other Perthshire-ringed recoveries were local) (see page 91).



February, away records outnumber local records by 8 to 4. The record from Roxburghshire was in November of the first year. As most of the records relate to the period July-April in the first year of life, no conclusions can be drawn about later years.

The remaining 4 records are of birds ringed on the mainland of Scotland: 3 are of local recoveries, and the other is of a Perthshire bird in Northumberland in January of its first winter. There are no records relating to the Hebridean population.

### Montagu's Harrier (*Circus pygargus*)

Excluding two birds which may never have flown, there are 24 records. One bird was trapped as an adult, released after a short interval in the next county and found dead (remains) in the latter a year later. The rest were all ringed as nestlings in different parts of England and Wales; 13 were recovered in their first autumn and 10 in subsequent summers.

#### *First autumn recoveries of birds ringed as nestlings.*

3 were recorded locally (same or neighbouring county, up to 55 miles) in, respectively, August, September (1st) and October—but the last had been dead for some time. One was recovered in August (12th) about 180 miles E.N.E., having travelled from N. Wales to E. Yorkshire. The remaining 9 were recovered abroad as follows:—

<i>Recovery date</i>	<i>Displacement</i>
First year:	
8th September ... ..	Devon—Corrèze, France
ca. 10th     "     ... ..	Co. Durham—Marne, France
15th       "     ... ..	Anglesey—Deux-Sèvres, France
21st       "     ... ..	Norfolk—Cantal, France
22nd       "     ... ..	Hampshire—Vendée, France
27th       "     ... ..	Anglesey—Basses-Pyrénées, France
1st October ... ..	Norfolk—Somme, France
4th       "     ... ..	Devon—Vendée, France
—         "     ... ..	Yorkshire—Minho, N. Portugal

The records from the departments of Marne, Corrèze and Cantal indicate overland flight: the others are from near the Channel and Atlantic seaboard.

#### *Recoveries in subsequent summers of birds ringed as nestlings.*

6 birds were recovered locally in subsequent summers (May-September), 2 in the second year, 3 in the third and one (ringing data imperfect) in the sixth or seventh. The other 4 were recovered (one perhaps long dead) at a distance from place of birth as follows:—

<i>Recovery date</i>	<i>Displacement (approx. in miles)</i>
Second year:	
August ... ..	Devon—N. Wales (170 N.)
Third year:	
May ("remains") ... ..	Hampshire—Scilly Isles (225 S.W.)
"     ... ..	Dorset—Pas-de-Calais, France (160 E.)
June ... ..	N. Wales—S. Scotland (130 N.)

The last was found dead near a nest with eggs.

*British recovery of bird ringed abroad.*

One ringed as a nestling on Texel, Holland, was recovered in Suffolk in June a year later.

**Osprey** (*Pandion haliaëtus*)*British recoveries of birds ringed abroad.*

There are 5 records of birds ringed as nestlings in different parts of Sweden, as follows:—

<i>Recovery date</i>	<i>Displacement</i>
First year:	
September ... ..	Hälsingland—Roxburghshire
October ... ..	Småland—Suffolk
Second year (ending 31st March):	
“Spring” ... ..	Stockholm—Norfolk
Third year:	
May (22nd) ... ..	Västergötland—Moray
November ... ..	Västergötland—Inverness-shire

## SUMMARY

**GOLDEN EAGLE.**—The sole record is of little significance.

**BUZZARD.**—Birds native to Great Britain are shown to be largely sedentary, with limited random wandering (at least some of it in the first autumn) on the part of a minority; the recorded displacements are all less than 100 miles.

**ROUGH-LEGGED BUZZARD.**—A bird native to Sweden (Jämtland) has been recovered in N. Scotland in its first winter.

**SPARROWHAWK.**—Birds native to the British Isles are shown to be sedentary: only 5 out of 158 recoveries cannot be described as local, and even among these the greatest recorded displacement was under 100 miles. The oldest bird was nearly eight years of age. There is a heavy recorded mortality in the summer months, which can be related to game-preserving.

Birds ringed as full-grown and recovered at a distance may therefore be presumed to be migrants of foreign origin. Some of these apparently winter in Great Britain, while others pass on to Holland and France. In two instances the recoveries indicate S. Norway (Valdres) as the summer area of the particular individuals. Birds ringed as full-grown and recovered locally are of unknown origin and the records cannot be interpreted.

A bird native to S. Norway has been recovered in S. England in its first autumn. Birds ringed on autumn migration on Heligoland and in Holland have been recovered in England, Wales and Ireland in winter.

**MARSH HARRIER.**—One bird native to Norfolk was found in N. France in its second August, and another reached Morocco in its second winter; four others were recorded either locally or elsewhere in southern England before they had migrated, and a fifth a year later. One native to a southern English county was still there in its first December. A bird native to Denmark was recovered in Orkney in a subsequent spring.

**HEN HARRIER.**—Of birds native to Orkney, some are shown to remain there during the winter while others (probably a majority, at least in their first year) move south throughout the mainland of Scotland. One born in a mainland locality (Perthshire) reached the north of England (Northumberland).

**MONTAGU'S HARRIER.**—Birds native to England and Wales are recorded, in their first autumn, from both coastal and inland localities in France and, in one instance, from N. Portugal. One young bird showed a pre-migratory movement in a north-easterly direction. In subsequent summers some birds return to their native localities, but there are exceptions: there is an indication that a bird from N. Wales may have bred in S. Scotland in its third year, and one from Dorset was recovered in N.E. France at like age. A bird native to Holland (Texel) has been recovered in Suffolk in June of the following year.

**OSPREY.**—Five birds native to Sweden have been recovered in Great Britain—one in Moray as late as 22nd May (when about two years old).

## A NORTH ATLANTIC TRANSECT IN SEPTEMBER

By P. W. P. BROWNE

THIS PAPER is a record of birds seen during a voyage on S.S. "Empress of France" from Liverpool to Montreal via Inishtrahull and Belle Isle, from 21st to 28th September 1956. It covers only the Offshore and Pelagic Zones, i.e. excludes the Mersey and the River St. Lawrence. Details of daily position are given in Table I. The only positions mentioned in this paper which are accurate are the noon positions shown in this Table. All others have been obtained by interpolation from these and may be up to half a degree out.

TABLE I—POSITIONS AND TIMES OF OBSERVATION DURING A CROSSING OF THE NORTH ATLANTIC, SEPTEMBER 1956

(The ship did not leave Liverpool until 2142 hours G.M.T., and therefore no relevant observations were made on that day; similarly, birds seen on 27th and 28th September, when the ship was in the River St. Lawrence, have also been excluded from this paper.)

Date	Noon position	Longitude traversed during daylight	Duration of observations	
			Hours	Minutes
Sept. 22	55° 46' N, 09° 41' W	6°—13°	8	00
23	56° 32' N, 22° 37' W	19°—26°	9	05
24	56° 05' N, 35° 52' W	33°—39°	6	37
25	54° 01' N, 47° 41' W	45°—50°	7	15
26	50° 43' N, 58° 24' W	55°—61°	7	20

At various places in the text, I have compared my findings with those contained in the two "classic" North Atlantic papers: Wynne-Edwards (1935) and Rankin and Duffey (1948). Hereafter, these papers are referred to by the authors' names only. None of the routes they traversed lies as far north as mine throughout its length, but Wynne-Edwards covered part of the western half in mid-September 1933, and Rankin and Duffey the eastern in September and October 1943.

I used three methods of watching for birds:

- (1) looking at the sea and ship from some vantage point with the naked eye, inspecting anything of interest with binoculars or telescope;
- (2) counting at intervals birds present in the wake (which might include birds up to a mile or so astern);
- (3) scanning with binoculars approximately one square mile of ocean.

The third method did not occur to me till we were one day out, but on 23rd, 24th and 25th September, I made 43 scans. On the assumption that I could spot most sea-birds at a range of up to half a mile (using  $6 \times 30$  binoculars), I watched steadily at right angles to the ship's course for the time ( $3\frac{1}{2}$  minutes) it took the ship to travel 2 miles. Observations by these three methods were made for continuous periods of up to  $3\frac{1}{4}$  hours, separated by intervals not exceeding  $1\frac{3}{4}$  hours, throughout the day.

#### SEA-BIRDS

PETRELS (Hydrobatidae).—Up to 3 probable Storm Petrels (*Hydrobates pelagicus*) were in the wake between  $9^\circ$  and  $24^\circ$ W. They never approached near enough for me to see details of their feet. Actual counts were:

Longitude W.	$9^\circ$	$10^\circ$	$11^\circ$	$12^\circ$	$13^\circ$	$19^\circ$	$20^\circ$	$21^\circ$	$22^\circ$	$23^\circ$	$24^\circ$
Number counted in wake	3	0	0	0	0	0	1	2	0	0	0
		1	1	0	0	0	1	1	0	1	
		3	1			3		2	0	1	
		1	1			1			0		

These figures are in agreement with Wynne-Edwards's observations a little further south in September 1933, but Rankin and Duffey saw none at all in the area of my observations at the same time of year.

A few miles N.W. of Inishtrahull, I noticed a party of *ca.* 10 apparent Leach's Petrels (*Oceanodroma leucorhoa*) circling over the water. Other probable Leach's were three single birds as follows: south at  $55^\circ 40'N.$ ,  $09^\circ 30'W.$ , west at  $56^\circ 00'N.$ ,  $11^\circ 50'W.$  and in Belle Isle Strait. Thus I saw none in the belt between  $40^\circ$  and  $50^\circ W.$ , where they have been reported as common in

September by Wynne-Edwards and by Rankin and Duffey. Perhaps they pass south earlier in some years than in others.

**SOOTY SHEARWATER** (*Procellaria grisea*).—3 seen: one flying S. or S.E. at  $55^{\circ}40'N.$ ,  $08^{\circ}40'W.$ ; one south at  $55^{\circ}46'N.$ ,  $09^{\circ}45'W.$ ; one among flock of Kittiwakes at  $53^{\circ}50'N.$ ,  $48^{\circ}40'W.$  These observations are in accord with previous records.

**GREAT SHEARWATER** (*Procellaria gravis*).—2 seen: one north at  $54^{\circ}30'N.$ ,  $45^{\circ}10'W.$ ; one west at  $54^{\circ}30'N.$ ,  $45^{\circ}30'W.$  Also 2, too distant for certain identification but probably this species, north at  $55^{\circ}30'N.$ ,  $07^{\circ}20'W.$  and S.W. at  $56^{\circ}00'N.$ ,  $11^{\circ}50'W.$  It is surprising that so few were seen, though it is likely that some were missed since we passed through  $40^{\circ}$ - $45^{\circ}W.$  in darkness and the only two seen for sure occurred at dawn the next day.

**FULMAR** (*Fulmarus glacialis*).—Seen daily in open ocean. For comparison with the figures of Wynne-Edwards, I give the average and maximum numbers counted in the wake for every five degrees of longitude:

Longitude W.	5°	10°	15°	20°	25°	30°	35°	40°	45°	50°	55°
No. counted	2	7	7	4	8	0.4	1	no	25	10	
in wake	3	22	8	13	15	2	3	counts	150	16	

The largest concentration was at dawn on 25th September ( $54^{\circ}30'N.$ ,  $45^{\circ}10'W.$ ) when there were about 150 in the wake. Sailors on deck told me they had been noticed in the ship's lights for about three hours previously, so there must have been many between about  $43^{\circ}30'$  and  $45^{\circ}W.$

Records of the density of Fulmars per square mile have not often been published, so I give my actual counts for each degree of longitude:

Longitude W.	20°	21°	22°	23°	24°	25°	26°	34°	35°	36°
Number counted	1	1	4	3	1	1		1	0	
in one square mile	1	0	4		1	1		1	1	
							0		1	
							1		1	

Longitude W.	36°	37°	38°	39°	45°	46°	47°	48°	49°	50°	51°
Number counted	2	1	0		15	12	14	4	9	14	
in one square mile		1	3		24	22	11	15	4	10	
						18	19	10	2		
								4	9		
								6			

The direction of flight of Fulmars not in the wake was noted on 22nd September. Wind was approximately S.E. force 3.

Direction of flight	N	NE	E	SE	S	SW	W	NW
Number of Fulmars counted	4	1	19	75	8	1	1	0

The only dark-phase Fulmars were three single birds between 48° and 49° W.

All these observations agree with those of previous ornithologists, except that I found no sign of the concentration noted by Wynne-Edwards and by Rankin and Duffey, between 30° and 40° W., from mid-summer into September.

There seems to be difference of opinion among the experts as to the effect a ship has on Fulmars. Wynne-Edwards believes that the ship attracts these birds, and considers it necessary to count Fulmars in the wake, as they habitually follow ships. However, from aerial observation, Rankin and Duffey found that, on some occasions, Fulmars were more numerous beyond the outer screen of ships in a convoy, which indicates that they avoided the ships. My own observation was that, though a few Fulmars counted in square mile scans went into the wake, most were unaffected by the presence of the ship and continued on their way. Consequently I believe that the figures given above for square mile counts are valid samples of the true density in the areas concerned.

**GANNET** (*Sula bassana*).—Many seen in the eastern Atlantic; one adult in the Gulf of St. Lawrence. The following table is designed to show the change in abundance of the species and the change in proportion of immature to adult birds west from the Irish coast on 22nd September.

Longitude W.	6°	7°	8°	9°	10°	11°	12°	13°	Total
Adult	11	58	24	19	1	0	0		113
Third summer	0	0	0	0	0	0	1		1
First summer	0	2	0	4	0	0	0		6
Juvenile	0	0	0	1	0	0	3		4
Immature (age uncertain)	0	0	1	1	0	0	0		2
Total	11	60	25	25	1	0	4		126

On this day the wind was S.E. force 3, and the direction of flight as follows:

Direction of flight	N	NE	E	SE	S	SW	W	NW	Not noted
Number of Gannets counted	0	0	60	39	14	3	0	1	9

The 3 flying S.W. were the juveniles (1 + 2) between 12° and 13° W. Another juvenile was seen on 23rd September at 56° 30' N., 24° 10' W., flying S.E. (wind W. force 3). None of the five juveniles seen was with an adult. Plumage details summarized by Kay (1950) were used to determine the age-group of each bird.

These observations are in close accord with others already published. It is noticeable that immature birds occur further from

the coast than do adults. The directions of flight on 22nd September for both the Gannet and the Fulmar emphasize the tendency of sea-birds to fly into the wind, as remarked by Thom (1956).

**SKUAS** (*Stercorariidae*).—Small numbers daily in the ocean and Belle Isle Strait. Adults, identified for certain, were as follows:

Aretic Skua (*Stercorarius parasiticus*): one over wake at 56°00'N., 12°20'W.; one in Belle Isle Strait.

Great Skua (*S. skua*): one from N.W. to wake at 55°40'N., 08°40'W.

Long-tailed Skua (*S. longicaudus*): one east at 53°50'N., 48°20'W.; two in Belle Isle Strait (21 and 25 miles west of Belle Isle).

Others, not identified specifically, were seen as follows: singly at 55°50'N., 10°40'W.; 56°20'N., 19°50'W.; 56°10'N., 35°20'W.; 55°40'N., 38°40'W.; three at 53°40'N., 48°50'W.; six in Belle Isle Strait (up to 25 miles west of Belle Isle).

The records of Long-tailed Skuas in Belle Isle Strait are surprising in view of the emphasis by both Wynne-Edwards and Rankin and Duffey on mid-ocean movements. The largest number of skuas occurred where there were concentrations of Kittiwakes.

**GULLS** (*Laridae*).—Except for Kittiwake, seen only near Inishtrahull and from Belle Isle through Gulf of St. Lawrence. When we were passing Inishtrahull, the first (3 Great Black-backed, *Larus marinus*) appeared about 8 miles N.E. of the island, and there was a maximum of 18 (13 Great Black-backed, 4 Herring Gulls, *L. argentatus*, 1 Lesser Black-backed Gull, *L. fuscus*) about 6 miles to the N.W.; all had left when the ship was 13 miles W.N.W. of Inishtrahull. In Belle Isle Strait, Great Black-backed and Herring Gulls were common, and the latter followed the ship through most of the Gulf (up to 100 counted in wake).

**KITTIWAKE** (*Rissa tridactyla*).—Most numerous in western Atlantic. None seen from Inishtrahull to 10°W., but between 10° and 26°W. single immature birds occurred in the wake. There were none between 33° and 39°W. From 45° to 48°W., I counted 4 individuals (2 adult, 2 immature) and then we ran into a heavy concentration. Counts per square mile between 48° and 49°W. gave 12, 15, 33 (including a flock of 20), 3, 6. This was followed by a reduction to 0-3 per square mile between 49° and 51°W. In this area, the proportion of adults to immature birds was 13:6. In Belle Isle Strait, Kittiwakes (both adult and immature) were numerous and small numbers occurred up to 60°W. in the Gulf of St. Lawrence. These observations confirm previous reports of great scarcity of Kittiwakes in pelagic waters

in September (Rankin and Duffey), though with a concentration about  $50^{\circ}$ W. (Wynne-Edwards).

TERNs (Sternidae).—One flying N.E. at  $54^{\circ}30'N.$ ,  $45^{\circ}50'W.$ , and two pairs flying east through Belle Isle Strait. All were too far distant for specific identification.

AUKS (Aleidae).—Very small numbers near Inishtrahull (from 10 miles N.E. to 10 miles N.W. of the island); one was a Razorbill (*Alca torda*). No more seen till a total of 9 (up to 3 together) probable Brünnieh's Guillemots (*Uria lomvia*) between  $45^{\circ}$  and  $47^{\circ}$ W. In Belle Isle Strait there were 6 Little Auks (*Alle alle*) (about 15 miles W.S.W. of Belle Isle) and about 10 auks unidentified.

#### LAND-BIRDS

WADERS (Scolopaeidae and Charadriidae).—At  $55^{\circ}50'N.$ ,  $11^{\circ}00'W.$ , an immature Sanderling (*Crocethia alba*) approached from the east and disappeared from my view beneath the ship's stern. Another small wader, probably a Dunlin (*Calidris alpina*), flew low over the wake and towards the S.W. at  $56^{\circ}30'N.$ ,  $21^{\circ}20'W.$  A few hours later, at  $56^{\circ}30'N.$ ,  $23^{\circ}50'W.$ , two waders were seen approaching the ship high from the N.W. They descended to about 200 feet and were identified as Ringed Plovers (*Charadrius hiaticula*). They continued on their course S.E., presumably flying direct from Greenland to Europe.

TURTLE DOVE (*Streptopelia turtur*).—One joined the ship at  $56^{\circ}30'N.$ ,  $21^{\circ}20'W.$  (i.e. about 450 miles W.N.W. of Ireland) on 23rd September. It was seen several times during the day, flying from one part of the ship to another. The last occasion was at  $56^{\circ}40'N.$ ,  $25^{\circ}40'W.$ , which must be one of the most westerly records for this species.

[BUDGERIGAR (*Melopsittacus undulatus*).—On 22nd September at 0615 hours G.M.T., at a point ( $55^{\circ}30'N.$ ,  $06^{\circ}45'W.$ ) roughly half-way between Islay, Scotland, and the north coast of Co. Donegal, Ireland, one appeared on board for a few minutes.]

WHEATEAR (*Oenanthe oenanthe*).—One seen on the ship at  $55^{\circ}40'N.$ ,  $09^{\circ}20'W.$  and one at  $55^{\circ}50'N.$ ,  $11^{\circ}00'W.$

ROCK PIPIT (*Anthus spinoletta*).—One flying around ship at the same time as the Budgerigar.

REDPOLL (*Carduelis flammea*).—One on board at dawn, Belle Isle Strait.

LAPLAND BUNTING (*Calcarius lapponicus*).—One appeared from the stern at  $56^{\circ}30'N.$ ,  $21^{\circ}30'W.$  and stayed on the ship all day



(last seen at 56°40'N., 26°00'W.). Several times it took flight, and once went about a  $\frac{1}{4}$ -mile to the E.N.E., but it always returned.

**SNOW BUNTING** (*Plectrophenax nivalis*).—Two overtook the ship at 53°50'N., 48°40'W., and continued west.

## REFERENCES

- KAY, G. T. (1950): "Migratory movements of Gannets". *Brit. Birds*, xliii: 230-232.
- RANKIN, M. N. and DUFFEY, E. A. G. (1948): "A study of the bird-life of the North Atlantic". *Brit. Birds*, xli: supplement.
- THOM, A. M. (1956): "Birds of a trans-Atlantic voyage in late spring 1954". *Brit. Birds*, xlix: 80-84.
- WYNNE-EDWARDS, V. C. (1935): "On the habits and distribution of birds on the North Atlantic". *Proc. Boston Soc. Nat. Hist.*, 40: 283-346.

## PHOTOGRAPHIC STUDIES OF SOME LESS FAMILIAR BIRDS

### LXXXVI. CHOUGH AND ALPINE CHOUGH

Photographed by RICHARD VAUGHAN and HAROLD PLATT

(Plates 21-24)

Text by I. J. FERGUSON-LEES

CHOUGHS (*Pyrrhocorax* spp.) are medium-sized crows with almost completely uniform blue-black plumage, striking red legs and a brightly-coloured beak. There are only two species—the common Chough (*P. pyrrhocorax*), with a slender, decurved, red bill about two inches long, and the so-called Alpine Chough (*P. graculus*), which has a shorter, stouter and straighter yellow beak. Our photographs of these two birds come respectively from Wales and from Monte Maiella in the Central Apennines of Italy. A comparison of plates 22 and 23 will give some indication of the differences in the bill-shapes, though it is from directly beneath, as the bird flies over, that one is particularly struck by the slenderness of the beak of the common species.

Both birds have a very similar body-size and are a little larger but more delicate (and actually lighter in weight) than a Jackdaw (*Corvus monedula*), the only species with which either is likely to be confused in Europe (apart from each other). Both are, however, readily distinguished from the Jackdaw at shorter ranges by their coloured bills and legs, their lack of a grey nape and their generally more slender forms; while at longer ranges, in flight, their more graceful builds and seemingly more flexible wings—with primaries invariably separated and often curving upwards—make them easily picked out, even when they are not uttering their characteristic calls (see below). (The form of a Chough's spread

wing is to some extent illustrated in plate 23, though a bird that is just taking flight is perhaps hardly a fair example.)

Thus it is with each other that the two choughs are only really likely to be confused and in some areas this is a definite possibility because the ranges and habitats of the two species overlap, sometimes to quite an extent. Earlier I referred to the "so-called" Alpine Chough because this name perhaps conveys an impression that this species is confined to the high mountains and at the same time suggests that the other is absent from such places. Neither of these suggestions is true, as we shall see, and so for the rest of this discussion the names of "Red-billed Chough" and "Yellow-billed Chough" will be used.

In Europe the Red-billed Chough is confined to western Ireland and the west of Britain, to the very north-west corner of France, to Spain, Portugal and the Pyrenees, the Alpine area, southern Italy, Sardinia and Sicily, and parts of the Balkan peninsula; while the Yellow-billed is found in northern and (locally) south-eastern Spain, the Pyrenees, the Alpine area, northern and central Italy, Corsica, and a rather larger area of the Balkans. Both are found in Morocco and Algeria, and the Red-billed Chough in the Canary Islands (but only on Palma). Eastwards both species extend to Turkey, Syria, Palestine, Persia, the Himalayas and Sinkiang, while the Red-billed bird also breeds further east still, in Mongolia and China. Thus it can be seen that there is a certain similarity between the two ranges, and in fact almost all the countries which hold Yellow-billed Choughs fall within the range of the Red-billed bird. The distribution of both species is, of course, limited by their need for mountainous country, though the Red-billed Chough is also found on sea-cliffs in some parts of its range (particularly the British Isles). Two typical views of Yellow-billed Chough habitats are shown in plate 21, but these photographs equally well illustrate what would in many areas be occupied by the Red-billed species, and the oft-repeated statement that the Alpine Chough nests at much higher altitudes than the Red-billed needs a certain amount of qualification. The two species frequently nest at almost exactly the same altitudes, sometimes together, and—though the Red-billed does certainly descend much lower to breed—at least in some parts of Europe the Alpine does not go any higher: Dr. Vaughan tells me that in the Central Apennines, where his photographs were taken, the Red-billed nests just as high as the Alpine, and in the Sierra Nevada in Spain he has found the Red-billed at 11,000 feet. On the other hand, I have seen Alpine Choughs in Spain at 2,000 feet. In *The Birds of the British Isles* (1953, vol. I, p. 57) D. A. Bannerman writes: "That altitude is no barrier to the red-billed chough was proved by the members of the 1921 Everest expedition, A. F. R. Wollaston recording that several choughs (*P. pyrrhocorax himalayensis* was the race in point) visited the camp on Mount Everest at 20,000 feet. Col. Meinertzhagen, referring to the same race, wrote that

he found the chough equally at home on deep snow or in grassy meadows or on almost barren plains”.

Both species descend from the mountains to the valley bottoms in winter, but neither is migratory—and, in fact, the Yellow-billed Chough in particular is extremely sedentary, which is why, very rightly, the one shot in Oxfordshire in 1881 was not accepted as an addition to the British list since it had almost certainly escaped from captivity (see *The Handbook*, vol. I, p. 39). A similar origin seems probable for the single Heligoland record of this species. Even allowing for this sedentariness, however, it is surprising how slow both choughs are to spread and colonize new areas, particularly when one thinks of the way in which the opportunist Jackdaw is always ready to break new ground. It is sometimes suggested that the Jackdaw is responsible for the Red-billed Chough habitats are shown in plate 21, but these photo-Jackdaws evicting Choughs from their nest-holes, but as far as Cornwall is concerned B. H. Ryves (*Bird Life in Cornwall*, 1948) dismisses this as a factor, probably quite rightly. Certainly the problem is not as simple as that, for there are many areas where the presence of Jackdaws has no effect on the Red-billed Choughs and there are other places where the Choughs decline, or at least fail to spread, even though there are no Jackdaws. An interesting case, which is not understood at the moment, is the status of the Red-billed Chough in the Jackdaw-free Canary Islands. Here—see Bannerman (*op. cit.*) and also J. M. Cullen *et al.* (*Ibis*, vol. 94, pp. 72-73 and 78)—Red-billed Choughs are abundant on the island of Palma, where they may be seen in various habitats in “flocks of up to 300” (Cullen); yet there are none on any of the other apparently equally suitable islands of the group.

As this last observation suggests, choughs—both species—are extremely gregarious and often nest colonially; pairs are, however, not infrequently found breeding singly and this is almost the rule with Red-billed Choughs in Britain. On the Continent the Yellow-billed Chough probably seldom gathers in such big colonies as the Red-billed—in the Central Apennines Dr. Vaughan found them in colonies of 3-6 pairs—but both flock in big parties. The Iberian peninsula is one of the strongholds of the Red-billed species and in the sierras of Spain one can see flocks of two hundred or more in the air together. Similarly, P. A. D. Hollom tells me that he has seen a flock of some 300 Yellow-billed Choughs in the Pyrenees. Just as the two species will sometimes nest together, so may they be found mixing in the same winter flock.

It is at such times that one is particularly faced with the difficulty of separating the two species at a distance and in flight. The bill-colours cannot clearly be seen except at quite close range, even in excellent light, though at moderate distances the beak of the common species appears dark, while the Alpine Chough's short bill looks whitish. So that it is upon the calls that one frequently has to rely. Choughs and Jackdaws, like most gregarious species,

are fortunately very noisy birds and their cries are distinctive. The Red-billed Chough has one note, often repeated twice, from which the English name of the two species was originally derived, but its commonest cry is one that is like a Jackdaw's in general form, but much more musical and higher-pitched, and drawn out at the end so that it seems to become 2-3 syllables instead of one; there is a certain resemblance to the more drawn-out calls of young Jackdaws, though the Chough's cry is much stronger; other notes remind one of the calls of gulls and even of domestic chickens. The Yellow-billed bird, though at times uttering a note that is something like the Jackdaw call of the Red-billed, has more particularly a rippling *chirrish* of variable pitch, and a very shrill and explosive *tsee-up*. Both species will call on the ground and, when they do so, have a rather pleasing characteristic of dipping their heads and slightly raising their wings and tails.

Diving flights and compact aerial evolutions are a feature of both choughs, and this is an added help for distinguishing distant flocks from Jackdaws. The normal flight of the choughs is much stronger and more purposeful than any Jackdaw's—a mixture of slow but powerful flaps and buoyant glides, at times interspersed with deep dives on closed wings. But it is the complicated aerial evolutions, wheeling and soaring, rolling over and diving, which make a flock of choughs such a characteristic sight. Such a flock forms a much tighter unit than one of Jackdaws does, the birds often keeping in a sort of ball, with little straggling; yet within the flock, though it moves along together, many individuals seem to be milling around in circles; and the whole unit will sweep and drift from mountain top to valley bottom and back again. Even in large parties, however, it is noticeable that the pairs seem to keep together; apparently this is the case throughout the year and it is thought that choughs mate for life. It is certainly noticeable that the same nesting-sites may be used year after year.

Both species typically nest deep in holes and crevices, though some nests of the Red-billed bird may be quite open (plate 23). In the Central Apennines Dr. Vaughan found that the Yellow-billed Chough usually bred in a cavern or hole in the limestone crags which jut out at 7,000-8,000 feet in the Monte Maiella *massif*. The bird in plates 22 and 24 was photographed at the entrance to a nest which was almost exactly in the centre of the crag face shown in plate 21 lower. This nest was some 10 feet down a hole that was about 3 feet across at the top but larger inside. There were 5 eggs on 17th June 1953 (a late year when there was still much snow): two of these had hatched by the 22nd, and the photographs were taken on the 23rd and the 26th. In both species the female alone seems to build the nest and to incubate the eggs: when she is sitting the male calls her off to feed every 20 minutes or half an hour. At the nest where he obtained his photographs Dr. Vaughan found that the male always arrived with a group of other Yellow-billed Choughs, and there was much calling, to

which the female would reply from inside the nest. She would then leave to join the party for a few minutes; feeding was thus always communal.

Choughs feed on insects and their larvae, spiders, crustaceans, molluscs, lizards and in some areas on various seeds and fruit. Cullen *et al.* (*loc. cit.*) found that on Palma in the Canary Islands oranges and figs were taken from trees by the numerous Red-billed Choughs there. In lower mountainous country one finds that choughs frequently repair to certain particular areas of rough grass to feed communally. The separate ecology of the two species remains to be worked out, but there is probably little food competition with the Jackdaws. The long bill of the Red-billed Chough is presumably of considerable advantage in probing for insect larvae and worms.

Dr. Vaughan found that the returning female Yellow-billed Chough would always fly straight into the nest-hole and he suggests that they may like a cavity large enough to do this; on the way out, however, she would always perch and this is when the photographs were taken (plates 22 and 24). As shown in the case of the Red-billed Chough on plate 23, the nests are usually rather bulky structures, built of sticks, heather and other plant stems, and lined, crow-like, with a thick pad of wool and other mammal hair. The Red-billed bird usually lays 4-6 eggs, while there is some evidence that the Yellow-billed's clutch tends to be slightly smaller (3-5). Incubation for the Red-billed is given in *The Handbook* as 17-18 days and fledging as 38, while J. B. Szczepski (1953, *Pomocnicze Tabele Ornitologiczne*, p. 2) gives the periods of the Yellow-billed bird as 21 and 31-32 days respectively. Both are single-brooded.

In conclusion, a look at the nearly fledged young Red-billed Chough on plate 23 does illustrate a small warning that should perhaps be given. When first fledged, young Red-billed Choughs have bills that vary from pinkish-red to pinkish-yellow, rather shorter and straighter than that of the adult (but still quite fine), and there is therefore the possibility of the newly-fledged youngster being mistaken for a Yellow-billed Chough by the unwary. Incidentally, in certain lights the legs of adults of both species may look quite pink (rather than red), and Cullen *et al.* say that on Palma "adults and juveniles examined in the field at the end of July had legs pink, not coral-red, and bill sometimes more reddish-pink".

## THE BIRDS OF TIREE AND COLL

By J. MORTON BOYD

(Concluded from page 56)

COMMON TERN (*Sterna hirundo*).—May to September. Bred numerous in Tiree before 1892; numerous (1898); more common than the Arctic Tern

(1913); 18 pairs at Loch a' Phuill 1949; small colonies 1952; about 20 pairs with Black-headed Gulls at Loch Bhasapol June and July 1952; about 25 nests at Loch a' Phuill July 1955. Less common than the Arctic Tern 1949-55. Bred in Coll before 1899, but has never been recorded as numerous; not seen 1923; seen nesting on small off-shore islands 1937-38; present July 1939, August 1945, June 1946 and 1949, mid-May 1954; 4 seen June 1955.

**ARCTIC TERN** (*Sterna macrura*).—May to September. Abundant breeder in Tíree 1892-98; scarcer by 1913; several small colonies in June 1948 and 1952; numerous small colonies (usually less than 30 pairs in each) on shore, *machair* and moor in July 1952 and 1955, and much more numerous than the Common Tern. Bred in Coll before 1899; bred 1937-39, 1945-49; seen May 1954, June 1955. 30 pairs nesting in Gunna in June 1949. Present at Skerryvore June and July 1903-06.

**ROSEATE TERN** (*Sterna dougallii*).—1 seen on the wing in Tíree July 1955 (W.K.R.).

**LITTLE TERN** (*Sterna albifrons*).—May to October. Bred in Tíree before 1892; several small colonies (1898 and 1913); 12 pairs at Traigh a' Bheidhe July 1942; small colonies of 4-6 pairs early June 1949 and 1952; about 30 pairs at Traigh a' Bheidhe July 1952, but none there July 1955; colony of at least 50 pairs at old airfield runways, and about 10 pairs at the estuary of An Fhadhail, July 1955. Several birds seen in Gunna in June 1949 and May 1954. No breeding record yet available for Coll, though the species probably breeds at the western end of that island. 1 seen at Tíree 24th October 1953.

**SANDWICH TERN** (*Sterna sandwicensis*).—Reported occasionally on migration about 1913, usually in August, one having been shot and identified. Reported from Gunna by F. Fraser Darling in recent years, and 1 was recently seen in Tíree (J.T.D.W.). No breeding record from the area.

**RAZORBILL** (*Alca torda*).—Present all year in the sea area. Bred in Tíree before 1898; nesting 1912, 1913; 3 pairs with young July 1942; several pairs June 1949; 80 birds estimated June 1952; 34 birds with young July 1955 (all records from Ceann a' Mhara, Tíree). Present at Skerryvore on migration and in summer 1903-06, and seen there July 1955.

**LITTLE AUK** (*Alle alle*).—Winter. Small flocks seen in the sea area with a few coming ashore dead (1898). In recent years they have come ashore usually in February and March (J.T.D.W.); 1 dead 2nd February 1954 (J.G.).

**GUILLEMOT** (*Uria aalge*).—Present all year in the sea area. Probably the most common breeding bird on cliffs at Ceann a' Mhara, Tíree, in 1891, about 400 pairs recorded; still breeding there, but out-numbered by Razorbills, in 1898, 1912, 1913; bred 1920 (Seton Gordon); not breeding 1942, 1949, 1952, 1954 or 1955. 2 birds seen under the cliffs June 1952, but none July 1952; 5 seen under the cliffs June 1955, but none July 1955 (all records from Ceann a' Mhara). Passed Skerryvore in vast flocks in August 1903-06, and numerous there July 1955. No breeding record from Coll, but seen off-shore on many occasions July-August 1937-55.

**BLACK GUILLEMOT** (*Uria grylle*).—Spring to autumn. Bred in both islands before 1871 (Gray, 1871); bred in Tíree in small numbers in 1898, 1912, 1913; at Ceann a' Mhara 2 pairs were noted in recent years (J.T.D.W.); 1 bird seen flying into a cliff fissure June 1952; 1 seen on sea under the cliffs June 1955. Odd birds have been recorded at a few points around the coast of Tíree in recent years in summer. In Coll a few pairs bred 1938; 4 seen off-shore there July 1939; 1 seen August 1945; 2 and 3 seen late April 1955; 1 seen June 1955. A few spent the winter at Skerryvore in 1906.

**PUFFIN** (*Fratercula arctica*).—Present all year in the sea area, but much scarcer in winter. Very rarely seen at Skerryvore 1903-06. No sign of breeding in the area at any time.

**PALLAS'S SANDGROUSE** (*Syrhaptes paradoxus*).—An extraordinary passage of many small flocks took place in Tiree from May to October 1888 (the year of one of the two greatest invasions of Britain by this species). No further record from the area.

**ROCK DOVE** (*Columba livia*).—Present all year. Bred in Tiree before 1794, in Coll before 1843, and was breeding in both islands in 1899. Bred abundantly, especially at Ceann a' Mhara, Tiree, 1912, 1913; fairly plentiful there 1949-55. Breeding reported also from other places on the coast of Tiree, and at ruins, during 1949-55. A pair seen leaving a crevice in Gunna in June 1949. In Coll it was common in summer 1929, 1938-39, 1945-49; common and widespread 1954-55. Abundant in Tiree in winter, native birds probably augmented by migrants from the mainland. Flocks of up to 100 feed in the croftlands and roost at Ceann a' Mhara caves and ruined buildings.

**WOODPIGEON** (*Columba palumbus*).—2 killed at Skerryvore 21st December 1897; 1 seen at Arinagour, Coll, 26th April 1955. No record from Tiree.

**TURTLE DOVE** (*Streptopelia turtur*).—1 seen at Balinoe, Tiree, September 1951 (J.G.); 1 shot early November 1953 (J.T.D.W.). Recorded in Coll (Baxter and Rintoul, 1953).

**CUCKOO** (*Cuculus canorus*).—May to September. Occurred sparingly in Tiree in 1898 and 1913; a pair seen regularly in west Tiree 1951; a young bird seen there 6th September 1954 (N.McI.). Common in Coll 1899, young birds seen in August; 7 breeding females present there June 1938; heard and seen frequently June to August, 1945-49; at least 3 present mid-May 1954; 2 seen June 1955. One seen, being mobbed by pipits, in Gunna in June 1949.

**BARN OWL** (*Tyto alba*).—A single bird recorded in Tiree (Harvie-Brown and Buckley, 1892).

**SNOWY OWL** (*Nyctea scandiaca*).—Young male seen in Tiree in November 1873; 1 seen in Coll during winter 1891-92.

**LONG-EARED OWL** (*Asio otus*).—Seen at Skerryvore 12th November 1906; seen in Tiree recently (J.T.D.W.).

**SHORT-EARED OWL** (*Asio flammeus*).—Seen in Tiree December 1897, November 1888 and 1897; a regular migrant, sometimes numerous, October-November and January-February, 1898-1913; seen early April 1954; an owl seen in twilight in June 1952 (J.M.B.) was probably of this species. Seen at Skerryvore November 1897. No record available for Coll.

**NIGHTJAR** (*Caprimulgus europaeus*).—A single bird seen in Coll (Irby, 1899).

**SWIFT** (*Apus apus*).—Summer. No breeding record. Seen in Tiree before 1899, but not in Coll. Occasional summer-visitor, always singly, 1898-1913; 15 together over Ceann a' Mhara 7th July 1955; flock of 20 over the Reef 20th July 1955. One seen in Coll June 1946 (M.H.). Seen on passage at Skerryvore during August 1903-06.

**KINGFISHER** (*Alcedo atthis*).—1 shot in Coll 22nd July 1903 (Irby, 1903).

**SKYLARK** (*Alauda arvensis*).—Present all year. Bred abundantly before 1899 in both islands, and is reported still to breed in abundance in Tiree 1912-55, and in Coll 1937-55. A few pairs were seen in Gunna in June 1949 and May 1954. Abundant in the stubbles and stackyards September to March, flocks usually less than 100 birds. Migrants from the mainland probably over-winter in Tiree. Passage noticed at Skerryvore, August to March, 1897-1906.

**SWALLOW** (*Hirundo rustica*).—April to September. Did not breed in Tiree (1892, 1898, 1913), though odd birds reported April to September then; also June 1912, May 1948, and June 1949 and 1952. Breeding proved in Tiree 1950, 5 nests being seen at Caoles (L.A.U.); 3 occupied nests seen there July 1955. Seen in Tiree April to September 1954-55, maximum number together 8. A pair seen at a ruin, Arnabost, Coll, June 1949, but breeding not proved. Seen in Gunna May 1954. Observed at Skerryvore May and June 1897-98.

HOUSE MARTIN (*Delichon urbica*).—Bred at Arinagour, Coll, 1898, but no further nesting record for the area. Birds seen, usually singly or in pairs, in Tiree 31st May 1949, 29th May 1952 and 9th July 1955. No recent record from Coll.

SAND MARTIN (*Riparia riparia*).—Summer. Nested in Tiree 1794, and bred till at least 1886 at Gott; rare visitor (1888); not breeding 1898-1913; seen at the same site by 2 independent observers May and June 1952, and elsewhere 1954; breeding re-established at Crossapoll, Tiree, 5 pairs being found with burrows and young, in July 1955 (J.M.B.). Seen at Skerryvore early August 1897. No record from Coll.

GOLDEN ORIOLE (*Oriolus oriolus*).—In Coll 1 seen September 1938.

RAVEN (*Corvus corax*).—Present all year. A pair seen at Ceann a' Mhara 1891; bred every year in Tiree (1898 and 1913), usually beginning March; fledged family seen June 1949; present July 1952; nesting Ceann a' Mhara April 1954-55. In Coll it bred before 1899; at least 2 pairs 1938; parties of up to 6 birds seen July 1939; nesting 1945-49; several seen together and singly mid-May 1954; widespread, 20-30 birds seen, late April 1955; 3 seen 2nd-3rd June 1955. Present throughout the winter, singly or up to 3 together.

CARRION CROW (*Corvus c. corone*).—Anderson (1913) reports the occasional occurrence of this bird. No breeding record. In Tiree 3 seen January 1948; 17 in February 1953; 2 in July 1955.

HOODED CROW (*Corvus corone cornix*).—Present all year. Common breeder in both islands before 1899. Common in Tiree 1912, 1913, 1949-55. Probably less than 12 pairs attempt to breed in Tiree, sometimes on flat ground, and about half that number in Coll. Bred in Coll 1938; 3 or 4 pairs said to have bred 1939; present 1945-49; fairly common May 1954; evenly distributed April 1955; 5 seen June 1955. Present in Gunna in May and June 1949 and 1954. More numerous in winter than at other times, due possibly to migration from the mainland. Usually not more than 3 seen together in winter.

ROOK (*Corvus frugilegus*).—Seen in Tiree 14th August 1897; occasional visitor in Tiree March and November (1913); 6 seen there 13th November 1955. Large numbers at Skerryvore 1st November 1893, 14th-16th November 1897, 26th November 1898; 1 seen 6th April 1906. In Coll 1 seen May 1937. It is thought that small numbers arrive in winter from Mull.

JACKDAW (*Corvus monedula*).—Seen at Skerryvore November 1893. Anderson (1913) reports it as an occasional visitor usually in November; 1 seen 4th February 1951 (I.W.).

CHOUGH (*Pyrhocorax pyrrhocorax*).—No breeding record in Tiree and Coll since before 1871. Seen rarely at Ceann a' Mhara about 1913, but none recorded since.

GREAT TIT (*Parus major*).—Only record, 1 seen in whins at Gott, Tiree, March 1950 (J.G.).

WREN (*Troglodytes troglodytes*).—Present all year. Not thought to breed in Tiree (1898, 1899, 1913), though odd birds were seen in summer; seen June 1912; 2 singing males at Ceann a' Mhara June 1952; breeding proved at Hynish July 1952, newly fledged young seen being fed by adult (J.M.B.). Bred in Coll before 1899; bred 1938; present July 1939, August 1946, June 1946 and 1949, and May 1954; 1 seen June 1955. Common September to April, 1898-1955.

FIELDFARE (*Turdus pilaris*).—October to April. Common migrant before 1892; large flocks in late autumn and a few in spring (1898); odd birds remained all winter (1913); large numbers October and November, and small numbers December to March (with occasional rushes in February), 1952-56. Seen at Skerryvore in a great rush 23rd October 1897; scarce in spring there, but abundant during October and November 1903-06.



**MISTLE THRUSH (*Turdus viscivorus*).**—November to May. No breeding record from the area, although 1 was seen in Coll in mid-May 1954. Occasional autumn and spring visitor to Tiree since before 1898; frequent straggler November to March (1913); 1 seen there early April 1954. Usually seen singly or up to 3 together, and on open ground.

**SONG THRUSH (*Turdus philomelos*).**—Present all year. Numerous breeder in Coll before 1899, but not reported breeding in Tiree till 1903 and 1906. Nesting, and fledged young seen, in Tiree in 1945, 1952, 1955; single birds seen in June 1952, mid-May 1954, June and July 1955. In Coll, nesting in 1929 and 1938; present July 1939; nests 1945-49; present May 1954; 15 possible pairs early April 1955; 1 seen June 1955. Birds observed in Coll June 1929 (Miss E. V. Baxter), and in Tiree June 1945, showed characteristics of the sub-species *T. p. hebridensis*, and a buff-coloured thrush was seen in Coll on 9th November 1926. Plentiful October to April, 1898-1956, being most numerous in November, both in Tiree and at Skerryvore.

**REDWING (*Turdus musicus*).**—September to May. No breeding record, but 1 seen in whins at Arinagour, Coll, 12th May 1954. Common or abundant in Tiree and at Skerryvore October 1897, autumn 1908, 15th-25th October 1914, 29th October-1st November 1954, 12th-15th November 1955. Seen at Skerryvore as early as 27th September. A few over-winter in Tiree, 1913-55, usually disappearing during hard frost. The main autumn movement takes place after that of the Song Thrush, and before that of the Fieldfare. Anderson (1913) relates abundance of this species directly with that of Snipe.

**RING OUZEL (*Turdus torquatus*).**—1 killed September 15th 1898 at Skerryvore and the species was seen occasionally there in spring and autumn 1903-06.

**BLACKBIRD (*Turdus merula*).**—Present all year. Bred in Coll before 1899, but had not bred in Tiree by 1913. Pairs and singing males seen in Tiree, by several observers, at 6 widely scattered sites in June and July 1952-55; 1 empty nest found June 1952; nest with 4 young, in whins, June 1957 (J.M.B.). Bred in Coll 1937-39; a few seen there in summer 1945-49; several seen May 1954; 11 possible breeding pairs late April 1955; 2 seen 2nd-3rd June 1955. The main autumn movement is almost coincidental with that of the Redwing; rushes at Skerryvore early November 1897, 19th October 1898; and in Tiree, mid-November 1955. Less common on passage than the Song Thrush or Redwing. Odd birds present December to February 1954-55.

**WHEATEAR (*Oenanthe oenanthe*).**—March to October. Bred in both islands before 1899. Bred in Tiree (1913), all over the island; fledged family seen there July 1942; a few birds seen June 1949; several pairs breeding there, but not common, June 1952; numerous and breeding June and July 1955. In Coll, bred 1938; fairly common July 1939; common and breeding 1945-49; common May 1954; widespread April 1955; 6 seen June 1955. Seen in Gunna May 1954. Plentiful on migration, especially late March to early April, and occasionally numerous as late as October, 1898-1913. At Skerryvore, seen as early as 5th February 1898 and, on the return passage, 15th-20th August, onward into October, 1903-06. Distinct movement seen in Tiree 2nd-5th April 1954, and 25th-30th April 1955. A proportion of the autumn migrants are of the sub-species *Oe. oe. leucorrhoea*: 1 such bird was shot 8th October 1910; seen regularly in September in recent years.

**STONECHAT (*Saxicola torquata*).**—Present all year. Bred in Coll before 1899, and first reported breeding in Tiree that year. In Tiree newly fledged young seen, 1899-1913; pairs and single cocks seen there by 5 independent observers from 7 different sites, between April and June, during 1950-55. In Coll, 12 pairs estimated June 1938; common July 1939; several pairs nesting 1945-49; several pairs seen May 1954; 1 pair seen early April 1955. Regular winter visitor in small numbers November to April, 1898-1913; odd birds seen October to December, 1953-55.

**WHINCHAT (*Saxicola rubetra*).**—Seen in Tiree twice, April and May, about 1890; no recent record there. In Coll, bred before 1899; 1 pair seen there

May 1937; several pairs said to nest 1945-49; none seen April to June 1954-55. Seen at Skerryvore 22nd August 1897 and 22nd April 1898.

**REDSTART** (*Phoenicurus phoenicurus*).—Seen at Skerryvore 27th March and 1st October 1897, 6th October 1903, 21st September 1906. No recent record.

**BLACK REDSTART** (*Phoenicurus ochruros*).—Occasionally seen on migration in Tiree, and at Skerryvore (Baxter and Rintoul, 1953).

**ROBIN** (*Erithacus rubecula*).—September to April. No record of breeding in Tiree, but "breeds occasionally" in Coll (Macdougall, 1938); 1 male singing in Coll 23rd April 1954, but not reported by 5 observers in 7 different summers, 1939-55. Seen on passage in Tiree 26th October 1897, 3rd October 1898; and at Skerryvore 10th April 1906. Single birds have over-wintered in Tiree stackyards since before 1898; 1 seen there on 5 occasions January to February 1948-55; 1 seen mid-September 1956. Baxter and Rintoul (1953) suggest that some of the birds are of the sub-species *E. r. rubecula*.

**GRASSHOPPER WARBLER** (*Locustella naevia*).—1 killed at Skerryvore 8th May 1907.

**SEDGE WARBLER** (*Acrocephalus schoenobaenus*).—May to September. No breeding record from either Tiree or Coll before 1937 and 1938, when 2 possible pairs seen in Coll. Observed regularly in Tiree in recent years: seen July 1951; 3 singing cocks June 1952; at least 6 singing cocks July 1955; present September 1956. In Coll, 3 singing cocks were seen 2nd-3rd June 1955. Seen at Skerryvore 13th May 1898.

**BARRED WARBLER** (*Sylvia nisoria*).—1 seen in Tiree 9th September 1913.

**GARDEN WARBLER** (*Sylvia borin*).—Seen at Skerryvore 8th September and 20th October 1897.

**WHITETHROAT** (*Sylvia communis*).—May to September. Nested in Coll in 1891, and 1 pair seen there 1903. First summer record in Tiree was of a displaying pair June 1939 (N.Mcl.); seen July 1951; 4 singing males at scattered sites, and fledged young at Hynish, June and July 1955 (J.M.B.); present late September 1956. In Coll, no mention for summers 1937-39; 1 pair nested 1945; several birds seen June-August 1945-49; 3 singing males seen mid-May 1954; 5 singing males 2nd June 1955. Seen on migration in Tiree 5th-16th September 1913.

**WILLOW WARBLER** (*Phylloscopus trochilus*).—April to September. No definite breeding record. None reported from Tiree June and July, but 3 possible breeding pairs in Coll in June 1938; 4 seen in Coll July 1939; 1 seen June 1946; 1 pair at Arinagour mid-May 1954; 7 singing males in Coll late April 1955. Regular migrant in Tiree and at Skerryvore since 1889, April-May and August-September. Several seen in Tiree in April and May 1954-55, and in mid-September 1956.

**CHIFFCHAFF** (*Phylloscopus collybita*).—April-May and September-November. Anderson (1913) mentions two records in Tiree in 25 years' observation; single birds seen there mid-May 1954, mid-November 1955, and mid-September 1956. In Coll, 1 seen in song 19th April 1955 (J.R.F.).

**WOOD WARBLER** (*Phylloscopus sibilatrix*).—1 seen in Tiree on 12th May 1954, and another at Arinagour, Coll (perhaps the same bird) on 15th May 1954 (J.M.B.).

**YELLOW-BROWED WARBLER** (*Phylloscopus inornatus*).—1 killed at Skerryvore 21st September 1906.

**GOLDCREST** (*Regulus regulus*).—March, April, September and October. Seen in Tiree (1898); 1 seen there mid-October 1909; a few in spring in late years (1913); 5 seen at different places 3rd-9th April 1954; 1 present 8th-12th September 1956. Rushes at Skerryvore 22nd March, 22nd April and 19th November 1898; and 60 there 24th March 1906.



Richard Vaughan

HABITAT OF ALPINE CHOUGHIS (*Pyrrhocorax graculus*): ITALY, JUNE 1953. These limestone cliffs of the Maiella massif in the Central Apennines form a typical habitat which, incidentally, is shared by Wallcreepers (*Tichodroma muraria*); here, at a height of 7,000-8,000 feet, the Alpine Choughs breed in small colonies of 3-6 pairs (see page 101).



Richard Vaughan

NEST-SITE OF ALPINE CHOUGHIS (*Pyrrhocorax graculus*): ITALY, JUNE 1953. Plates 22 and 24 were obtained at a site in the centre of this picture. The nest itself was some 10 feet down a hole, for both species of chough usually breed deep in crevices and caverns (but see plate 23). Mountain cliffs and rocky outcrops of this kind are equally typical habitats of the common species and sometimes the two nest near each other (see page 100).



Richard Vaughan

ALPINE CHOUGH (*Pyrrhoroxy spaciatus*) AFTER LEAVING NEST: CENTRAL APENNINES, ITALY, JUNE 1953  
 This illustrates the shape and size of the comparatively short, stout and straight yellow beak which distinguishes this species from the red-billed bird (cf. plate 23 and see page 99). Both species have a more or less uniform blue-black plumage, though the Alpine Chough is blacker and duller at close range. The legs in each case are red, looking pinkish-red at times (see page 103). Apparently the female alone incubates; at this nest she always dived straight into the hole on arrival, but perched in this way when leaving.



Harold Platt

CHOUGH (*Pyrrhocorax pyrrhocorax*) FLYING FROM NEST AND YOUNG: WALES

Both choughs are graceful in flight and a noticeable feature, which helps to separate them from Jackdaws (*Corvus monedula*), is that the primaries are clearly separated and often up-curved. Note that this species has a longer and more decurved bill, which is red; seen from below, as the bird passes overhead, this beak is much finer than the Alpine Chough's. The young bird, which takes about 5½ weeks to fledge, has a shorter and straighter bill, sometimes yellowish-pink. The bulky stick nests are thickly lined with wool (see page 103).



*Richard Vaughan*

ALPINE CHOUGH (*Pyrrhocorax graculus*) OUTSIDE NEST: ITALY, JUNE 1953. Choughs are larger but more slender (and actually lighter in weight) than Jackclaws (*Corvus monedula*). They are gregarious and may be seen in flocks of up to several hundred, the two species sometimes mixed. At moderate ranges the Alpine Chough's bill looks whitish, that of the other dark, but often identification must rest upon the calls; distant flocks are separable from Jackclaws by their characteristic flight and aerial evolutions (see page 102).

SPOTTED FLYCATCHER (*Muscicapa striata*).—Seen at Skerryvore (Baxter and Rintoul, 1953); 1 seen at Arinagour, Coll, July 1939 (A.G.S.B.).

PIED FLYCATCHER (*Muscicapa hypoleuca*).—1 seen at Skerryvore 21st September 1906.

DUNNOCK (*Prunella modularis*).—April to September. Seen in Tiree 19th September 1887; 1 exhausted bird seen there in 12 years' observation (1898); 1 seen in Tiree mid-September 1956. In Coll, none seen during summers 1937-39; but a few in summers 1945-49 (M.H.); 1 seen mid-May 1954; noted 5 times late April 1955.

MEADOW PIPIT (*Anthus pratensis*).—Present all year. Bred abundantly in both islands before 1899. It is reported by all observers since as a common breeder in both islands, and also in Gunna. Common on migration in flocks of sometimes over 100 birds in Tiree and at Skerryvore during March-April and August-October, 1898-55. The species winters in Tiree in large numbers.

TREE PIPIT (*Anthus trivialis*).—1 seen in Tiree in October 1954 (J.T.D.W.).

ROCK PIPIT (*Anthus spinoletta*).—Present all year. Bred abundantly in Tiree before 1892, and in Coll before 1899. Reported by all observers since as a common breeder in both islands, and probably also in Gunna, where it was seen in June 1949 and May 1954. Usually distributed around the rocky shores, but nests have been found about half a mile from the shore. No migration evident in Tiree, but was seen at Skerryvore 1903-06. Numerous in winter, but not flocking, 1952-55.

PIED/WHITE WAGTAILS (*Motacilla alba*).—The White sub-species *M. a. alba* passes through Tiree and Coll, and Skerryvore, in March-May and August-October. Extreme records are 18th March 1897 and 17th October 1910. Only summer record is 1 in Tiree 15th June 1951 (N.McI.). Harvie-Brown and Buckley (1892) report migratory flocks of up to 50, but Anderson (1898 and 1913) saw only parties of up to 6; only small parties seen August 1954, April 1955, September 1956. The Pied race *M. a. yarrellii* is reported from March to September. A successful breeding pair seen June 1938 (Macdougall, 1938), in Coll; common there in July 1939, August 1945, and June 1946 and 1949; present May 1954; 13 seen, some believed paired, late April 1955. In Tiree, seen June 1912 (N.H.); present at 2 sites there June-July 1952; 3 seen at the same site 3 times, May to July 1955. In Gunna, 1 seen 10th May 1954. Known on passage in Coll before 1899, and seen in Tiree and at Skerryvore March-May and August-September (some birds probably *M. a. alba*) (1897-98); 1 present January 1949; seen April 1954 in Tiree.

GREY WAGTAIL (*Motacilla cinerea*).—Only record is from a list for Tiree by Mr. K. W. Mackenzie (Harvie-Brown and Buckley, 1892).

YELLOW WAGTAIL (*Motacilla flava*).—Anderson (1898) does not report the species, but later (1913) mentions an odd bird every year on migration in Tiree. No recent record.

STARLING (*Sturnus vulgaris*).—Present all year. Bred abundantly about 1860 in Tiree and probably also in Coll. Anderson (1913) says that the species became twice as numerous during 1887-1913, and all observations since suggest that the large numbers have been maintained both summer and winter. Bred abundantly in both islands, nesting in ruins, in stone dykes, in oil drums lying in ditches, in loose flat mounds of stones, and in hawthorn trees, during 1949-55. Seen in Gunna in June 1949 and May 1954. Flocks of 1,000 or more are seen fighting in Tiree in winter to roost at the Ceann a' Mhara caves. A frequent visitor at Skerryvore October 1898, and throughout the year 1903-06; seen there in a great rush 6th-7th February 1897.

HAWFINCH (*Coccothraustes coccothraustes*).—1 killed at Skerryvore on 28th April 1904.

**GREENFINCH** (*Chloris chloris*).—Present all year. In Tiree first breeding record 1954, near Scarinish (J.T.D.W.); 1 male seen at Gott, 17th-20th June 1955. In Coll, 1 male seen June 1903; none seen by summer observers 1937-39 and 1945-49; 1 pair at Arinagour mid-May 1954; 5 seen, including pairs, 23rd April 1955; 1 seen 2nd June 1955. Known on passage and in winter since 1888; arrived in Tiree in considerable flocks usually in early November (1913); seen October to April, but most numerous October to December in flocks of up to 30 birds; over-wintered in Tiree usually in flocks of up to 6 during 1954-56. Seen at Skerryvore 25th October-15th November 1897, and 3rd November 1906.

**LINNET** (*Carduelis cannabina*).—Present all year. Bred occasionally in Tiree (1892), and many were said to breed in Coll (1899). None reported from Coll since, but in Tiree several pairs and odd birds, June 1952; 1 seen August 1954; a flock of 6 on 22nd October 1953; 10 birds together April 1954. Anderson (1913) mentions over-wintering in mild weather. The birds are of the sub-species *C. c. autochthona* (Baxter and Rintoul, 1953).

**TWITE** (*Carduelis flavirostris*).—Present all year. Bred in both islands before 1899, and has been reported breeding by all subsequent summer observers in both islands, and probably also in Gunna, where seen May 1954. Breeding plentifully, or present, August to May 1952-56, in flocks not usually exceeding 100, often much less. No distinct migratory movement, and none recorded at Skerryvore.

**REDPOLL** (*Carduelis flammea*).—Single birds, male and female, of the sub-species *C. f. rostrata*, seen in Tiree 12th and 27th September 1914; 1 of the sub-species *C. f. cabaret* (or *disruptis*) seen there 6th March 1903.

**BULLFINCH** (*Pyrrhula pyrrhula*).—Seen in Coll, but not in Tiree (Irby, 1899).

**CHAFFINCH** (*Fringilla coelebs*).—October to January. Seen at Skerryvore and in Tiree, October, November and January, 1897-1913. Anderson (1913) says that a few over-wintered; 2 males seen in Tiree in January 1949, and 3 solitary females in February 1952 and 1953 (I.W).

**BRAMBLING** (*Fringilla montifringilla*).—A large flock was seen in Tiree on 12th December 1898; 1 caught at Skerryvore October 1905; Anderson (1913) reports a few from Tiree. No recent record. No record from Coll.

**YELLOWHAMMER** (*Emberiza citrinella*).—April to November. Bred in Coll 1902-03; none noted there by observers between May and August 1937-49; 2 pairs seen late April 1955. No breeding record from Tiree, but seen there June 1912 (N.H.). Winter visitor in small numbers in Tiree (1898), 1 having been shot there 19th November 1888; 1 or 2 every autumn on passage (1913). No recent winter records from the area.

**CORN BUNTING** (*Emberiza calandra*).—Present all year. Numerous and breeding in both islands before 1899, and has been reported as plentiful by all subsequent summer observers. At least 30 males were singing in Tiree in June 1952, and probably more than 50 in June and July 1955. In Coll, at least 8 singing males June 1938; 4 there late April 1955; 2 seen June 1955. Migration is not evident, though Tomison (1907) mentions the "Common Bunting *E. miliaria*" at Skerryvore in spring and autumn, and this presumably applies to the Corn Bunting. Flocks of usually not more than 30 birds winter in Tiree.

**REED BUNTING** (*Emberiza schoeniclus*).—Present all year. Bred in Coll (1889), but not mentioned as breeding in Tiree (1898 or 1913). In Coll, 12 pairs estimated June 1938; several pairs July 1939; seen frequently summers 1945-46 and 1949; several pairs mid-May 1954; common late April 1955; 5 seen 2nd June 1955. In Tiree, first reported June 1912 (N.H.); present in suitable breeding habitat there June and July 1952, April and May 1954, May to July 1955. Fledged young seen being fed June 1957 (J.M.B., Donald Watson) and, though no actual nests have been reported, now thought to breed in fair



numbers in Tiree. Seen in small flocks of up to 20 birds in Tiree between October and December 1953-54, and in March and April 1945-55.

**SNOW BUNTING** (*Plectrophenax nivalis*).—September to March. A regular migrant in Tiree before 1898; seen there and at Skerryvore 10th-28th October and 1st-5th November 1897; 18th August 1898. Often seen in flocks of up to 30 at Skerryvore in September and October 1905. Main movements usually late October to early November, and early April (Anderson, 1913); 6 seen in Tiree November 1949. A pair seen in Gunna 13th November 1955. An extraordinary record (Anderson, 1913) is of a pair at Ceann a' Mhara in July.

**HOUSE SPARROW** (*Passer domesticus*).—Present all year. In 1888 there were none in Tiree; reported nesting there (1892); common (1898); very abundant (1913); reported as abundant, plentiful or common there since. Bred in Coll 1899, and has been recorded as abundant or common there since. Present in winter in flocks of usually less than 50, around croft-houses. No migration evident, with only a solitary record from Skerryvore in summer (Tomison, 1907).

**TREE SPARROW** (*Passer montanus*).—No recent records. Before 1889 (the date of arrival of the House Sparrow) it was an abundant or numerous breeding species; numerous (1898); scarce "ousted by the House Sparrow" (1913). Though several observers have subsequently searched the last breeding-areas of this species at Kirkapoll and Middleton in Tiree, none has been reported since, at any time of the year. Bred in Coll before 1899, but not recorded since. In the 25 years before 1913 *P. montanus* had been almost completely replaced by *P. domesticus*.

#### SUMMARY

The information is summarized in a table. It is designed to show as accurately as possible in a single line a maximum of information for each of the 176 species recorded in Tiree and Coll between 1892 and 1956. Both islands are separately represented; all records from the Skerryvore are included in Tiree, and all records from Gunna in Coll. There is an unfortunate lack of winter observations from Coll, but in cases where there is no reasonable doubt of its being otherwise, winter status there is judged to be similar to that in Tiree.

Attention is drawn to the following features which may illustrate regional and national trends: (i) the increase or establishment as breeding species of Fulmar, Gadwall, Pintail, Tufted Duck, Buzzard, Curlew, Redshank (Tiree), Black-headed Gull, Razorbill, Swallow, Wren (Tiree), Blackbird (Tiree), Sedge Warbler, Whitethroat (Tiree), Greenfinch, and Reed Bunting (Tiree); (ii) the decline or disappearance as breeding species of Mallard and Teal (both still fairly common), Common Tern (replaced partly by the Arctic Tern), Guillemot (replaced almost completely by the Razorbill), and Tree Sparrow (replaced completely by the House Sparrow); (iii) the decline in numbers in winter of Mallard, Gadwall, Scaup, Pochard, Goldeneye, Grey Lag Goose, Bewick's Swan, and Tree Sparrow; (iv) the increase in numbers in winter of Long-tailed Duck, Barnacle Goose, Whooper Swan, and Oystercatcher; (v) the increase in numbers in summer of the Mute Swan.

SUMMARY TABLE—THE COMPLETE LIST FOR TIREE AND COLL SHOWING STATUS CHANGES DURING THE PERIOD 1892-1956

c = very scarce to fairly common in Coll ; C = common to abundant in Coll ; t = very scarce to fairly common in Tiree ; T = common to abundant in Tiree ; \* = one record only ; † = breeding recently established in Tiree or Coll or both ; Inc = apparent increase in numbers ; Dec = apparent decrease in numbers ; N/C = no apparent change in numbers ; ? = doubtful and requires corroboration.

Species	Breeding			Spring			Summer (Non-breeding)			Autumn			Winter		
	Inc	N/C	Dec	Inc	N/C	Dec	Inc	N/C	Dec	Inc	N/C	Dec	Inc	N/C	Dec
Black-throated Diver ( <i>Gavia arctica</i> )			c		CT			CT		ct					ct
Great Northern Diver ( <i>Gavia immer</i> )					CT										CT
Red-throated Diver ( <i>Gavia stellata</i> )		C			Ct					ct					ct
Great Crested Grebe ( <i>Podiceps cristatus</i> )					t			t							t
Red-necked Grebe ( <i>Podiceps griseigena</i> )					T										
Slavonian Grebe ( <i>Podiceps auritus</i> )					T										T
Little Grebe ( <i>Podiceps ruficollis</i> )		t			T			c							T
Leach's Petrel ( <i>Oceanodroma leucorhoa</i> )										t					
Storm Petrel ( <i>Hydrobates pelagicus</i> )								T		T					
Manx Shearwater ( <i>Procellaria puffinus</i> )					CT			CT							
Great Shearwater ( <i>Procellaria gravis</i> )								t		t					
Sooty Shearwater ( <i>Procellaria grisea</i> )					t*										
Fulmar ( <i>Fulmarus glacialis</i> )	T			CT			C			ct					
Gannet ( <i>Sula bassana</i> )					CT			CT		ct					ct
Magnificent Frigate- bird ( <i>Fregata magnificens</i> )								t*							
Cormorant ( <i>Phalacrocorax carbo</i> )		t (?)			ct			ct		ct					ct
Shag ( <i>Phalacrocorax aristotelis</i> )		t			CT			CT		CT					CT
Heron ( <i>Ardea cinerea</i> )		e			ct			ct		ct					ct
Glossy Ibis ( <i>Plegadis falcinellus</i> )															t*
Mallard ( <i>Anas platyrhynchos</i> )				CT		CT						CT			CT
Teal ( <i>Anas crecca</i> )					ct	CT				CT					CT
Gadwall ( <i>Anas strepera</i> )		t				t						t			t
Widgeon ( <i>Anas penelope</i> )					c	CT		t		CT					CT
Pintail ( <i>Anas acuta</i> )†		t				t				t					t
Shoveler ( <i>Spatula clypeata</i> )		t				ct				t					t
Scaup ( <i>Aythya marila</i> )								t				t			t
Tufted Duck ( <i>Aythya fuligula</i> )					t	T						T			CT

Species	Breeding			Spring			Summer (Non-breeding)			Autumn			Winter		
	Inc	N/C	Dec	Inc	N/C	Dec	Inc	N/C	Dec	Inc	N/C	Dec	Inc	N/C	Dec
Pochard ( <i>Aythya ferina</i> )			t			t						t			t
Goldeneye ( <i>Bucephala clangula</i> )						t						t			t
Long-tailed Duck ( <i>Clangula hyemalis</i> )				CT									CT		
Common Scoter ( <i>Melanitta nigra</i> )			t			T			T						
Eider ( <i>Somateria mollissima</i> )		CT			CT			CT			CT				CT
Red-breasted Merganser ( <i>Mergus serrator</i> )		CT			CT			CT			ct				ct
Goosander ( <i>Mergus merganser</i> )						t			t			t			t
Smew ( <i>Mergus albellus</i> )						t						t			t
Shelduck ( <i>Tadorna tadorna</i> )		ct			ct						ct				ct
Grey Lag Goose ( <i>Anser anser</i> )			ct					t			t				t
White-fronted Goose ( <i>Anser albifrons</i> )						CT									CT
Brent Goose ( <i>Branta bernicla</i> )															t
Barnacle Goose ( <i>Branta leucopsis</i> )				T	C								T	C	
Canada Goose ( <i>Branta canadensis</i> )															t*
Mute Swan ( <i>Cygnus olor</i> )		ct			ct			cT			t				t
Whooper Swan ( <i>Cygnus cygnus</i> )						cT		t			cT		T	c	
Bewick's Swan ( <i>C. columbianus bewickii</i> )							t								t
Buzzard ( <i>Buteo buteo</i> )†		ct			ct						ct				ct
Hen Harrier ( <i>Circus cyaneus</i> )															ct
Peregrine ( <i>Falco peregrinus</i> )		t	c		t						t				t
Greenland Falcon ( <i>F. rusticolus</i> <i>candicans</i> )															t*
Morlin ( <i>Falco columbarius</i> )		ct			ct						CT				ct
Kestrel ( <i>Falco tinnunculus</i> )			ct		ct						ct				ct
Red Grouse ( <i>Lagopus scoticus</i> )			c			c							c		
Partridge ( <i>Perdix perdix</i> )			ct			ct							ct		
Quail ( <i>Coturnix coturnix</i> )								t							
Phasant ( <i>Phasianus colchicus</i> )			ct			t						t			t
Water Rail ( <i>Rallus aquaticus</i> )				t											t
Sora Rail ( <i>Porzana carolina</i> )															t*
Corncrake ( <i>Crex crex</i> )		cT			ct						ct				
Moorhen ( <i>Gallinula chloropus</i> )		t	c		t	c					t				t
Coot ( <i>Fulica atra</i> )			ct		ct						ct				t
Oystercatcher ( <i>Haematopus</i> <i>ostralegus</i> )		CT			CT						CT			ct	

Species	Breeding			Spring			Summer (Non-breeding)			Autumn			Winter		
	Inc	N/C	Dec	Inc	N/C	Dec	Inc	N/C	Dec	Inc	N/C	Dec	Inc	N/C	Dec
Lapwing ( <i>Vanellus vanellus</i> )		CT			CT						CT				CT
Ringed Plover ( <i>Charadrius hiaticula</i> )		CT			CT						CT				CT
Grey Plover ( <i>Charadrius squatarola</i> )											t				
Golden Plover ( <i>Charadrius apricarius</i> )		c	t		CT						CT				CT
Turnstone ( <i>Arenaria interpres</i> )					CT			ct			CT				CT
Snipe ( <i>Capella gallinago</i> )		CT			CT						CT				CT
Jack Snipe ( <i>Lymnocyptes minimus</i> )					t						T				T
Woodcock ( <i>Scolopax rusticola</i> )											T				T
Curlew ( <i>Numenius arquata</i> )†	t	c			CT			CT			CT				CT
Black-tailed Godwit ( <i>Limosa limosa</i> )					t						t				
Bar-tailed Godwit ( <i>Limosa lapponica</i> )					t						t				t
Wood Sandpiper ( <i>Tringa glareola</i> )								t*							
Common Sandpiper ( <i>Tringa hypoleucos</i> )			ct								t				
Redshank ( <i>Tringa totanus</i> )†	t	c			CT						CT				CT
Greenshank ( <i>Tringa nebularia</i> )			t		t						ct				
Knot ( <i>Calidris canutus</i> )					t						t				
Purple Sandpiper ( <i>Calidris maritima</i> )											CT				CT
Little Stint ( <i>Calidris minuta</i> )											t				c
Dunlin ( <i>Calidris alpina</i> )			cT		CT						CT				CT
Curlew Sandpiper ( <i>Calidris testacea</i> )											t*				
Sanderling ( <i>Crocethia alba</i> )					CT			ct			CT				CT
Ruff ( <i>Philomachus pugnax</i> )											ct				
Grey Phalarope ( <i>Phalaropus fulicarius</i> )											t				t
Red-necked Phalarope ( <i>Phalaropus lobatus</i> )			t												
Arctic Skua ( <i>Stercorarius parasiticus</i> )	c		t		ct			t			ct				ct
Great Skua ( <i>Stercorarius skua</i> )					t			t			t				t
Great Black-backed Gull ( <i>Larus marinus</i> )			ct		CT			CT			CT				CT
Lesser Black-backed Gull ( <i>Larus fuscus</i> )			CT		ct			ct			ct				
Herring Gull ( <i>Larus argentatus</i> )			CT		CT			CT			CT				CT
Common Gull ( <i>Larus canus</i> )			CT		CT						CT				CT



Species	Breeding			Spring			Summer (Non-breeding)			Autumn			Winter		
	Inc	N/C	Dec	Inc	N/C	Dec	Inc	N/C	Dec	Inc	N/C	Dec	Inc	N/C	Dec
Raven ( <i>Corvus corax</i> )		ct			ct						ct				ct
Carrion Crow ( <i>C. corone corone</i> )								t							
Hooded Crow ( <i>C. corone cornix</i> )		CT			CT						CT				CT
Rook ( <i>Corvus frugilegus</i> )					ct										t
Jackdaw ( <i>Corvus monedula</i> )															t
Chough ( <i>Pyrrhocorax pyrrhacorax</i> )													t		
Great Tit ( <i>Parus major</i> )					t*										
Wren ( <i>Troglodytes troglodytes</i> )†	t	c			t						t				t
Fieldfare ( <i>Turdus pilaris</i> )					ct						CT				ct
Mistle Thrush ( <i>Turdus viscivorus</i> )					t			c							t
Song Thrush ( <i>Turdus philomelos</i> )		ct			ct						CT				CT
Redwing ( <i>Turdus musicus</i> )					ct			c			CT				CT
Blackbird ( <i>Turdus merula</i> )†		ct			ct						CT				CT
Wheatear ( <i>Oenanthe oenanthe</i> )		CT			CT						CT				
Stonechat ( <i>Saxicola torquata</i> )		ct			ct						ct				ct
Whinchat ( <i>Saxicola rubetra</i> )		c					t				t				
Redstart ( <i>Phoenicurus phoenicurus</i> )					t						t				
Black Redstart ( <i>Phoenicurus ochruros</i> )					t						t				
Robin ( <i>Erithacus rubecula</i> )		c	c		ct						ct				ct
Grasshopper Warbler ( <i>Locustella naevia</i> )					t*										
Sedge Warbler ( <i>Acrocephalus schoenobaenus</i> )†		c?t						ct							
Barred Warbler ( <i>Sylvia nisoria</i> )											t*				
Garden Warbler ( <i>Sylvia borin</i> )											t*				
Whitethroat ( <i>Sylvia communis</i> )†	t	c									t				
Willow Warbler ( <i>Phylloscopus trochilus</i> )		c(?)			ct						t				
Chiffchaff ( <i>Phylloscopus collybita</i> )					ct										t
Wood Warbler ( <i>Phylloscopus sibilatrix</i> )					c*t*										
Yellow-browed Warbler ( <i>Phylloscopus inornatus</i> )											t*				
Goldcrest ( <i>Regulus regulus</i> )					t						t				
Spotted Flycatcher ( <i>Muscicapa striata</i> )								c*			t*				

Species	Breeding			Spring			Summer (Non-breeding)			Autumn			Winter		
	Inc	N/C	Dec	Inc	N/C	Dec	Inc	N/C	Dec	Inc	N/C	Dec	Inc	N/C	Dec
Pied Flycatcher ( <i>Muscicapa hypoleuca</i> )															t*
Duncock ( <i>Prunella modularis</i> )							c(?)								t*
Meadow Pipit ( <i>Anthus pratensis</i> )			CT			CT						CT			CT
Tree Pipit ( <i>Anthus trivialis</i> )															t*
Rock Pipit ( <i>Anthus spinoletta</i> )			CT			CT						CT			CT
Pied/White Wagtails ( <i>Motacilla alba</i> )	c					CT			t			CT			
Grey Wagtail ( <i>Motacilla cinerea</i> )															t*
Yellow Wagtail ( <i>Motacilla flava</i> )									t						
Starling ( <i>Sturnus vulgaris</i> )			CT			CT						CT			CT
Hawfinch ( <i>C. coccothraustes</i> )															t*
Greenfinch ( <i>Chloris chloris</i> )†		c(?)t				T						T			T
Linnet ( <i>Carduelis cannabina</i> )			t	c		t						t			
Twite ( <i>Carduelis flavirostris</i> )			CT			CT						CT			CT
Redpoll ( <i>Carduelis flammea</i> )						t						t			
Bullfinch ( <i>Pyrrhula pyrrhula</i> )															t*
Chaffinch ( <i>Fringilla coelebs</i> )												t			t
Brambling ( <i>Fringilla montifringilla</i> )												t			
Yellow Hammer ( <i>Emberiza citrinella</i> )			c			t						t			t
Corn Bunting ( <i>Emberiza calandra</i> )			cT			cT						cT			cT
Reed Bunting ( <i>Emberiza schoeniclus</i> )†			t(?)	c		ct						ct			ct
Snow Bunting ( <i>Plectrophenax nivalis</i> )						t			t			t			t
House Sparrow ( <i>Passer domesticus</i> )			CT			CT						CT			CT
Tree Sparrow ( <i>Passer montanus</i> )				ct		ct							ct		ct

## REFERENCES

- ANDERSON, P. (1898): "On birds observed in the island of Tiree". *Ann. Scot. Nat. Hist.*, 27: 153-161.
- (1913): "The birds of the island of Tiree". *Scot. Nat.*, 16: 73-78; 20: 170-172; 21: 193-200; 22: 217-224; 23: 241-245.
- (1892-1919): "Bird notes from Tiree". *Ann. Scot. Nat. Hist.* (1892), 4: 269; (1893), 5: 43; (1893), 6: 114; (1894), 10: 116; (1895), 16: 251; (1897), 24: 252; (1899), 29: 46; (1905), 56: 246; (1906), 60: 237; (1908), 66: 117; (1909), 69: 51; (1911), 78: 116; (1911), 80: 246; *Scot. Nat.* (1919), 94: 156.
- BAXTER, E. V., and RINTOUL, L. J. (1953): *The Birds of Scotland*. Edinburgh.
- BENNET, A. E. (1952): "Pintail (*Anas acuta*) nesting in Tiree". *Scot. Nat.*, 64: 117.
- BOYD, J. MORTON (1956): "Fluctuations of Common Snipe, Jack Snipe, and Golden Plover in Tiree, Argyllshire". *Bird Study*, 3: 105-118.

- DARLING, F. FRASER, *et al.* (1955): *West Highland Survey*. Oxford.
- FISHER, JAMES (1947): *Bird Recognition*, Vol. 1. London.
- GRAY, R. (1871): *The Birds of the West of Scotland*. Glasgow.
- HARVIE-BROWN, J. A., and BUCKLEY, T. E. (1892): *A Vertebrate Fauna of Argyll and the Inner Hebrides*. Edinburgh.
- HARVIE-BROWN, J. A. (1911): "Bird notes from Tiree". *Ann. Scot. Nat. Hist.*, 77: 52.
- HUNTER, D. G. (1927): "Buff-coloured thrush in Coll". *Scot. Nat.*, 163: 14.
- IRBY, L. H. (1899): "Observations on the birds of Tiree and Coll". *Ann. Scot. Nat. Hist.*, 32: 206-210.
- (1902-1903): "Bird notes from Coll". *Ann. Scot. Nat. Hist.* (1902), 41: 251-252; (1903), 45: 50; (1903), 48: 243-244.
- JACKSON, ANNIE C. (1914): "Birds of Tiree—additional records". *Scot. Nat.*, 25: 44.
- LAIDLAW, T. G. (1898): "Report on the movements and occurrence of birds in Scotland during 1897". *Ann. Scot. Nat. Hist.*, 28: 200-217.
- (1899): "Report on the movements and occurrence of birds in Scotland during 1898". *Ann. Scot. Nat. Hist.*, 31: 140-158.
- MACDOUGALL, H. (1938): "Notes on the birds of Coll". *Scot. Nat.*, 233: 139-144.
- MCINTYRE, N. (1953): "House Martins on Tiree". *Glasgow W. Scot. B. Bull.*, 3: 76.
- MEINERTZHIAGEN, R. and A. C. (1923): "On the occurrence of Faröe Snipe in the British Isles". *Scot. Nat.*, 139: 123.
- ROBINSON, H. W. (1914): "Birds of Tiree—additional records". *Scot. Nat.*, 25: 43.
- Statistical Account of Scotland (1791-1799)*. Edinburgh.
- STEPHEN, A. C. (1953): "Magnificent Frigate-bird in Scotland". *Scot. Nat.*, 65: 193.
- TOMISON, J. (1907): "Bird-life as observed at Skerryvore Lighthouse". *Ann. Scot. Nat. Hist.*, 61: 20-31.
- (1904): "Hawfinch at Skerryvore". *Ann. Scot. Nat. Hist.*, 51: 189.
- WILSON, R. (1914): "Enormous rush of Redwings at Skerryvore lantern". *Scot. Nat.*, 37: 21.
- WITHERBY, H. F., *et al.* (1938): *The Handbook of British Birds*. London.

## NOTES

**Glossy Ibis in Dorset.**—On 3rd December 1956, an adult male Glossy Ibis (*Plegadis falcinellus*) was shot in the water meadows of the River Frome at Stratton, near Dorchester, Dorset, by C. J. R. Pope. The bird was examined in the flesh by R. F. Dalton at the County Museum, Dorchester, but finally presented to Charterhouse School Museum, where the skin has been set up. Full details of the plumage and measurements have been supplied by J. J. Swift, who has examined the specimen critically, and these have been submitted to the Editors of *British Birds*.

Mr. Pope has confirmed that as far as he can remember the date of the occurrence was 3rd December, and not 6th December as stated in his letter published in *Country Life* of 7th March 1957. In fairness to Mr. Pope, who has given me permission to quote his name in this note, it should be said that he shot the bird in mistake for a Cormorant (*Phalacrocorax carbo*) and it was with much regret that he realised his error.

The last previously recorded occurrence of this species in Dorset was of four shot in Poole Harbour in 1877. ARTHUR BULL



**Pratincole in Hampshire.**—On 14th September 1957, at Stanpit Marsh, Christchurch Harbour, Hampshire, we observed a Pratincole (*Glareola pratincola*). We first saw it, with the sun behind us, at about twenty yards' range, when it was some fifteen feet above the ground. The bird flew in a 400-yard arc across the Marsh, before speeding low, south-west, across the Harbour. Shortly afterwards it appeared again and was watched fluttering up several times before finally settling on the water, where it was visible only as an elongated dark shape. From here it left to the north-west, up the Harbour.

The following points were noted: primaries and deeply-forked tail black, base of tail conspicuously though not extensively white, narrow white diagonal line from base of wing to carpal joint along edge of coverts, rest of upper-parts uniformly very dark brown; under-wing smoky with noticeably russet "lining" (i.e. axillaries and under-wing coverts), body beneath buff-white, darker in the upper breast and facial regions; shape and flight recalling Hirundines (an impression heightened by head-shape and short bill) and terns, although very broad base to rapidly-narrowing wing gave quite different proportions; fast, twisting flight with rapid, shallow wing-beats comparable only to that of a bat; size a little greater than Black Tern (*Chlidonias niger*), this species being present.

Although the bird was generally moving away from us and our gaze was directed mainly at the critical colour of the under-wing, we feel that, had a clear-cut throat shield been present, this would have been noticed. The bird was probably an immature changing into adult plumage. J. K. BOWERS and E. L. JONES

**Black-winged Pratincole in Somerset.**—On 15th June 1957, at Steart, Bridgwater Bay, Somerset, I was searching for young Lapwings (*Vanellus vanellus*) when I glanced up at the adult, and was surprised to see near it an entirely unfamiliar bird which at first sight I took to be a very small species of skua that was unknown to me. Through binoculars I saw a forked tail with white base, dark uniform olive-brown upper-parts and light, rather creamy, under-parts. The under-surfaces of the wings appeared uniformly dark, but I could not make certain of this as the bird flew away into the sun, in a leisurely rather tern-like fashion. In size it had appeared slightly smaller than the Lapwing, but more streamlined.

About two hours later, while driving through the common that runs to the shore at Steart, I spotted the bird again and obtained good views, with the sun behind me, as it stood on the grass about thirty yards from the car. The bird was clearly a pratincole (*Glareola* sp.)—the sandy brown head, distinctly lighter than the back (which was a dark olive-brown), the creamy black-bordered throat-patch, buffish under-parts and white belly could all be clearly seen. The legs were short, and the short slightly decurved bill had a red base. After ten minutes it started flying—apparently

hawking for insects—and on several occasions I had good views of the under-surfaces of the wings which were entirely black with no trace of rufous. Several times it flew near flying Redshanks (*Tringa totanus*) and it appeared to be approximately the same size. It eventually flew right away in the general direction of Burnham. I concluded that the bird could only be a Black-winged Pratincole (*G. nordmanni*).

JOHN REYNOLDS

**Pratincole or Black-winged Pratincole in Sussex.**—On 21st August 1955, a pratincole (*Glareola* sp.) was seen at the Midrips, near Camber, Sussex, by K. Linford, W. S. Nevin, B. P. Pickess, H. J. C. Seymour and the writer. The bird was first noticed flying overhead at a height of 40-50 feet, calling in a rather harsh, urgent manner. It appeared as a grey-brown plover with a long tapering body. Although the tail could be seen to be forked it did not open widely until the bird turned in flight. The chin, belly and under tail-coverts appeared to be pale, but the under wing-coverts seemed to be black with the remainder of the underwing dark grey. Noticeable flight features were the short neck, small bill and long, pointed wings. Some of the observers likened the bird to a huge Hirundine. As it flew overhead it gave us good views in excellent light, but it did not stop and could not afterwards be located.

The observers all considered the bird to be a Black-winged Pratincole (*G. nordmanni*), but it is appreciated that on such a view it is not always easy to differentiate between this and the Pratincole (*G. pratincola*).

J. W. DONOVAN

[We regret the delay in the publication of this note which originally prompted the preparation of P. J. Hayman's short paper entitled "A note on field-identification of pratincoles" which appeared in 1956 (*antea*, vol. xlix, pp. 312-313, plate 44), and readers are asked to turn to that to see why we do not consider that this record can be assigned with certainty to either bird. The observers say that the under wing-coverts "seemed to be black", but in flight overhead the undersides of the wings of *G. pratincola* look extremely dark, much more so than one might expect; and other points in the description fail to suggest the contrasting black-and-white appearance of *G. nordmanni*. The record of a Black-winged Pratincole in Somerset, however, which appears above, is entirely consistent with typical *nordmanni*. It should be added that intermediates do occur (see R. Meinertzhagen's *Birds of Arabia*, p. 474) and, in fact, the Taxonomic Sub-Committee of the British Ornithologists' Union now recommends (*Ibis*, vol. 98, p. 161) that "*G. nordmanni* be treated as a colour phase of *G. pratincola*, being more or less dominant in south-east Europe and south-west Asia. *G. nordmanni* has been found breeding in Iraq alongside *G. pratincola*, from which it differs nowise in either habit or migration".—EDS.]

**Great Skua harrying Shelduck.**—At 11.40 a.m. on 28th September 1957, in the estuary of the River Parrett, off Steart Point, Somerset, I had a Great Skua (*Stercorarius skua*) under observation. The bird was recognized by its large size—almost as big as a Great Black-backed Gull (*Larus marinus*)—general dark brown plumage, white patch on wings at base of primaries, heavy thickset body and neck, and short tail. When first seen, it was chasing a party of Shelduck (*Tadorna tadorna*) over the water. These joined other Shelduck resting on the surface, at which the skua then flew towards one of the duck and dropped bodily on to it. The Shelduck immediately dived in a shower of spray and the skua alighted on the spot, keeping its wings half-extended for a few seconds before closing them. After remaining on the water for a short time, the skua then rose and flew towards the nearest Shelduck to repeat the process. In all, in about five minutes, this was done approximately ten times, in each case the duck promptly diving before actually being struck. After the last occasion the skua sat on the water and was watched for a further fifteen minutes as it drifted out with the tide and the river, beyond the end of Steart Point.

R. ANGLES

**Black Terns feeding on mud-worms.**—On 26th September 1957, and again on the 28th, at the estuary of the River Parrett, Somerset, Black Terns (*Chlidonias niger*) were taking worms about 1½ inches long from the surfaces of mud-banks. There were 68 Black Terns present on the 26th (when I watched for two and a half hours) and 6 on the 28th: on each day most of them were actively engaged in feeding in this way. The method of flight was like the normal skimming action over water, the birds hovering above the mud and snatching up the worms without alighting. Sometimes a worm was dropped, but usually they were swallowed immediately. It should be added that the mud was very soft, having been covered during the morning by high spring tides, so much so that the various waders present were wading deep in it.

TREVOR SILCOCKS

**Apparent coition between House Martin and Sand Martin.**—On 13th May 1955, at Chew Valley reservoir, Somerset, I had a party of approximately thirty Sand Martins (*Riparia riparia*) under observation for well over an hour. For the whole of this time, whether they were in flight or resting on the ground, they were accompanied by a single House Martin (*Delichon urbica*). Other House Martins were flying up and down some distance away, but on no occasion was this bird seen to join them. After I had been watching for some little while, it became apparent that the House Martin was attempting coition with some of the Sand Martins feeding on the ground. When in flight it was trying to settle on their backs, or, if it was itself on the ground, it was making sudden lunges on birds near-by and then attempting to mount.

Then once, after hovering just above a resting Sand Martin, it succeeded in settling on this bird's back. Immediately the Sand Martin began quivering its wings and at the same time turned its head sideways and upwards during the few seconds when coition seemed to take place, while the House Martin retained its balance by a considerable amount of wing-flapping. Unfortunately, soon after this highly interesting performance, the whole flock flew off.

BERNARD KING

**Hoarding of food by Willow Tit.**—On 14th February 1957, a Willow Tit (*Parus atricapillus*) arrived at a feeding bowl which is set up about 10 feet from our house at West Wickham, Kent. It was one of a pair which frequented a strip of woodland at the rear of the house. The feeding bowl is filled every morning with shelled peanuts (*Arachis hypogaea*) split into halves. That day I was surprised to see that after taking a peanut the Willow Tit was returning within a few seconds for another. Instead of eating them, it was hiding them in various parts of the garden and also of the neighbouring garden. All were hidden within 20 yards of the feeder and no attempt was made to eat any until the bowl was empty. Then the tit started to search out and feed on the hidden nuts.

This became a daily occurrence in the six weeks that followed. Out of approximately 40-50 half-peanuts placed in the bowl each day, I estimated that some 15-20 were being removed and hidden by the Willow Tit. The other tits—Great Tit (*P. major*) and Blue Tit (*P. caeruleus*), of which there were about 10 altogether—seldom used to obtain more than two half-peanuts each—House Sparrows (*Passer domesticus*) accounting for the remainder. On two occasions, however, a Blue Tit was seen to remove peanuts hidden by the Willow Tit, while the latter was still emptying the feeding bowl.

The most common hiding-place was in the wire twists securing the chestnut palings of the garden fence, but other places were in crevices in the trunk of an oak tree and in the joints of some rustic trelliswork. The bird always seemed to experience some difficulty in locating the hidden peanuts, the paling fence being searched systematically each time it set out to recover them. On one occasion I found a peanut still wedged in the fence after the bird had left the garden and returned to the woodland.

During the last few days of March, just before the bird ceased to visit the feeding bowl, the habit of hiding food appeared to lessen, until finally the tit was feeding normally from the bowl. It was also about this time that I came to the conclusion that two different Willow Tits were now taking food from the feeder, as at a range of 10 feet slight differences in plumage could be seen. This second bird was never seen to hide food. DAVID HART

**Hoarding of food by Coal Tit.**—In the early part of October 1957, a Coal Tit (*Parus ater*) occasionally visited the feeding bowl

in our garden at West Wickham, Kent, to eat peanuts (*Arachis hypogaea*) (shelled and split into halves). Then on 22nd October it started to remove the peanuts and that day it hid 15 of them as follows:

- 1 in a clump of pinks
- 1 in a grass tuft
- 4 in various trees
- 5 in the soil
- 4 at ground level but precise place not seen

I inspected the ground in which one had been concealed, expecting to find the peanut under a stone or lump of soil, but the earth was level and free of stones. A close examination of the top surface failed to reveal the peanut, and I eventually found it by scraping away about one-eighth of an inch of earth. The peanut had been pushed into the fairly loose soil with the bill. When the feeder was empty the bird started to search for the peanut which I had disturbed, but gave up and found one which it had hidden in a tuft of grass. Unfortunately I had to cease watching at this point.

The following day it continued to hoard food, one peanut being inserted between the incurving petals of a chrysanthemum flower (which was in full bloom) and "hammered" into position with the bill. This peanut and one which had been hidden in the soil were found to be missing the morning after that.

On 5th November I refilled the feeding bowl as it became empty and a total of 64 peanuts were hidden in about half an hour, all within 30-40 yards of the feeder.

After this, hoarding of food continued almost daily. On 19th January 1958, the Coal Tit spent 2 hours 55 minutes (with three rests of between 5 and 15 minutes) taking 109 peanuts from the feeder. Of these, 7 were eaten straight away and 102 were hidden, 10 of the latter being partly eaten. These 102 were concealed as follows:

- 9 in brussel tops
- 1 in grass tuft
- 4 in plants
- 1 in the soil
- 87 in hawthorn hedges or trees

The bird then appeared to leave the area for that day and was not seen during the two hours remaining before nightfall.

Occasionally, when the Coal Tit tried to hide food at ground level, the House Sparrows (*Passer domesticus*) followed it around until the bird was forced to take to the trees. Blue Tits (*P. caeruleus*), Great Tits (*P. major*) and a Willow Tit (*P. atricapillus*) were also seen to follow the Coal Tit when it was looking for a hiding-place. A Great Tit and a Blue Tit were both seen to find peanuts hidden by the Coal Tit.

DAVID HART

**Abnormal Dipper breeding in North Wales.**—A pair of Dippers (*Cinclus cinclus*) nesting in the wooded valley of a Flintshire stream in 1957 consisted of a normal "chestnut belly" female and an abnormal "blaek belly" male. The blaek-brown and slaty plumage on the heads, backs and under-parts of these two birds was similar, thus ruling out the possibility of the male's being a wandering *C. c. hibernicus* from Ireland or the Isle of Man, but his chestnut belly was reduced to a narrow, irregular, broken belt which we found extremely difficult to see even under quite favourable conditions. With a frontal view, only slightly above horizontal, A. W. Boyd and W. Mulligan were unable to see it at all when they visited the nesting waterfall on 13th May.

We examined skins at the British Museum in November. Judging only from memory of our male, the degenerate chestnut belt below his white breast roughly resembled two winter males of *C. c. cinclus* from Scandinavia (Nos. 98.10.2.270 and 98.10.2.273) and an undated female from Ayr, Scotland, labelled *C. c. britannicus* (No. 1925.5.14.16).

Only about one mile of the stream concerned is accessible to us and this we have visited only irregularly, but as far back as 1953-54 a "black belly" and a "chestnut belly" wintered there together. Neither was in first-winter plumage, so it seems possible that our "blaek belly" male is a resident and at least six years old (unless, of course, he passes on the abnormality to his progeny).

We publish this note to point out the care needed in identifying a genuine Blaek-bellied Dipper (*C. c. cinclus*). It is possible that further observations may show that this variant occurs elsewhere.

L. S. V. and U. M. VENABLES

**Reed Warbler in Co. Down.**—On 21st June 1956, we heard a Reed Warbler (*Acrocephalus scirpaceus*) singing in the reed beds of Ballyherly Lough, near Portaferry, Co. Down. C. D. Deane (*Birds of Northern Ireland*, 1954) gives only two reliable records of this species: one killed at Maidens Lighthouse off Co. Antrim on 26th May 1944 and a nest with eggs at Monlough, Co. Down, on 25th May 1935.

L. S. V. and U. M. VENABLES

[This and the following note together possibly suggest a slight tendency to an increase in range.—EDS.]

**Reed Warblers in Anglesey.**—Vol. II (1938) of *The Handbook* does not include Anglesey in the range of Reed Warblers (*Acrocephalus scirpaceus*), but during recent years several have been heard singing there.

On 12th July 1950 W.M. heard one in shore-marsh reed-beds on the north side of Trecarddwr Bay and on 19th May 1957 L.S.V.V. heard two (possibly three) in the north-east reed-beds of Llyn Maelog, Rhosneigr. In this latter locality, too, Peter Wolstenholme heard one singing regularly during his visit from 5th to 10th June 1953.

W. MULLIGAN and L. S. V. VENABLES

[In his "List of birds seen in Anglesey and Caernarvonshire" (*North Western Naturalist*, new series, vol. 2, pp. 604-618), which covers observations during the eight years up to 1954, P. E. S. Whalley says of the Reed Warbler: "Rare on passage in Anglesey, breeding is not proven. One bird seen in May at Malldracth in 1951, but subsequent searching failed to find even the bird which must be regarded as a passage-migrant".—EDS.]

**Greenish Warbler in Kent.**—On 17th September 1957, a first-winter Greenish Warbler (*Phylloscopus trochiloides*) was trapped at Dungeness Bird Observatory, Kent, by Mr. and Mrs. N. Westwood, and brought to me. As they persuaded the bird across brambles into one of the Heligoland traps in the Moat, they were impressed by the paleness of the under-parts, contrasting with olive-green upper-parts, and by a long, whitish eye-stripe; a short bar on the closed wing was seen through binoculars as the bird paused momentarily. In shape, there was no perceptible difference from a Chiffchaff (*Ph. collybita*). No note was heard. A contrastingly lighter and brighter lower mandible was noticed when the warbler was in the catching-box.

In the hand, a detailed examination was made and the bird was weighed and measured. The full description has been sent to the Editors of *British Birds* with this note and it seems necessary to give here only the most significant features. The upper-parts were olive-green, brighter than those of a freshly-moulted Willow Warbler (*Ph. trochilus*). The short wing-bar was formed by yellowish-white tips to the outer webs of the first five greater coverts, the largest (central) tip being just over 2 mm. deep. There was no suggestion of any pale tips to the median coverts, and it should be added here that I could find no trace of abrasion on any of the wing or tail feathers (see discussion in next paragraph). The generally very pale under-parts and the long stripe (actually yellowish-white) from the base of the upper mandible above and well beyond the eye have already been mentioned. The wing (flat) measured 58.5 mm.; the 1st primary was 6 mm. longer than the primary coverts; the 4th primary was longest, with the 2nd 9 mm. shorter and falling between the 8th and 9th (this and the small wing suggest that the bird was a female); the 3rd was 1 mm. shorter than the longest, and the 5th and 6th were 0.5 mm. and 2.0 mm. shorter respectively; the 3rd to 6th primaries were emarginated on the outer webs. Other measurements: bill (from skull), 12.5 mm.; tail, 43.5 mm.; tarsus, 18.5 mm.; weight (when trapped at 16.00 G.M.T.), 7.4 gm. The upper mandible was dark brown and the lower a pale orange-brown, rather bright; iris very dark brown; tarsus grey-brown and soles of feet dirty greenish-yellow; inside mouth mainly yellow.

In the field, when released, the bird lost much of the rather bright olive-green appearance it had had in the hand, but was still greener than a Chiffchaff or a Willow Warbler. It did not

appear grey, as K. Williamson has described some birds of the European and W. Asian form, *Ph. t. viridanus* (the only race so far recorded in the British Isles), e.g. *antea*, vol. xlv, pp. 120-121 (first-winter bird), and vol. xlix, pp. 42-43 (adult). C. B. Ticehurst, in his *A Systematic Review of the Genus Phylloscopus* (London, 1938), describes one of the E. Asian races, *Ph. t. plumbeitarsus*, as greener than *viridanus* and as having a nearly similar wing-formula, but it seemed that races other than *viridanus* must be ruled out on the combination of wing formula with the lack of any trace of a (second) wing-bar on the tips of the unabraded median coverts. H. G. Alexander (*antea*, vol. xlvi, pp. 294-295) refers to individuals of *viridanus* "with olive-brown or even almost olive-green mantle" and directs attention to "the great variety of this species".

This is a first record for Kent.

H. E. AXELL

**Observations on a Corn Bunting roost in reeds.**—The roosting of Corn Buntings (*Emberiza calandra*) in reed-beds in the North Kent marshes has been described by E. H. Gillham (*antea*, vol. xlii, p. 328). The following observations were made at another Corn Bunting roost in reeds, at Winnall, Hampshire, in the Itchen Valley. The roost was first noticed on 13th October 1956, and the same bed of reeds was used until the end of November; after that, the buntings roosted in another part of the valley.

During the mornings and early afternoons of the period concerned small parties of Corn Buntings could be seen in the area, but not as many as appeared at the roost in the evening. This seemed to suggest that the birds were spending the day in the surrounding chalk-lands (mostly stubble and plough) and returning in the evenings to roost at Winnall. In the evenings, in fact, small parties of Corn Buntings could be seen flying in from the direction of the chalk-hills. The birds would start to arrive at the roost up to 45 minutes before sunset and small parties would continue to trickle in until just before sunset; the typical flight-note was constantly uttered as they came. On arrival, they would perch in hawthorn and willow bushes around the reed-beds, sometimes also on the branches of a dead oak. There most of them would remain, quite still, until the time came for them to enter the reeds, which was usually just before sunset; some, however, would perhaps make half-hearted attempts to preen themselves and small parties would occasionally take short flights over the surrounding marshes. Only occasionally would a bird go straight into the reeds without first stopping in the surrounding bushes. At times the numbers at the roost would rise up to about 80, but there were great fluctuations from day to day.

I have three other records of a Corn Bunting roost in reeds: perhaps the habit is commoner than reports suggest.

J. H. TAVERNER



## REVIEW

THE MUTE SWAN IN ENGLAND. By N. F. TICEHURST. (*Cleaver-Hume*, London, 1957). 131 pages; 32 plates in black-and-white and two-colour line. 35s.

THE LITTLE we know of the past history of birds in Britain is derived from archaeological research during prehistoric excavations, from mediaeval household accounts in which birds used for food are mentioned, from occasional references in early literature, many of which refer to falconry, and, in the 17th and 18th centuries, from the payments for "vermin" by churchwardens and petty constables. There is, however, one bird, the Mute Swan, with a long and detailed history, and to the study of this Dr. Ticehurst has devoted 30 years of intensive research.

To begin with, he examines and successfully disproves the long-accepted belief that the Mute Swan is not an English indigenous bird. That all our swans are derived from introduced birds must indeed have been held in doubt for some time by anyone who has considered their abundance as a wild species in southern Sweden and other parts of Europe. As Dr. Ticehurst points out, the Grey Lag Goose—whose bones, with those of the Mute Swan, have been found in peat deposits in East Anglia—bred in England until the 18th century and has now been absorbed in our farmyard stock; this provides an obviously parallel case.

The fact that the Mute Swan occupied a unique position as a Royal bird, a dignity it attained at some time before 1186, makes it possible to follow its career through the centuries in a way impossible with any other species. We learn that the King exercised a right to grant permits to keep swans and to mark them so that ownership could be proved. One of the principal reasons for their semi-domestication and protection was their value for food, especially on great occasions and an indication of their number is shown by the quantity supplied at feasts—for example, 400 at the installation of the Archbishop of York in 1466.

The laws for their protection, and the Courts of Swanmote to deal with these laws, are here given in detail. The Master of the Swans, a royal official, or his deputy, was evidently a man of some importance and his many duties were actively performed. A list of these worthies for many of the years between 1276 and 1799 has been compiled from various sources. Swan-rolls, 61 of which have been examined, contained the swan-marks used in each area; a "game" of swans was the group of swans in a given area, and their owner was rather delightfully known as a "gamester".

A discussion of these rolls leads to the examination of the actual swan-marks. Older readers of *British Birds* will remember Dr. Ticehurst's interesting papers on this subject (*antea*, vols. xvii, xix and xxii) and will be glad to have these and his other researches in permanent form. These swan-marks were made on the mandibles of the bill or on the leg and foot; they were the absolute property of the owner and could be bequeathed, left by

will or sold; a history of a number of them is given. "Swan-  
 upping", when the birds are marked, is now practised only on  
 the Thames, by the Royal Swanherd and those of two of the City  
 Livery Companies, and, near Norwich, on the Rivers Yare and  
 Wensum. Those with a regard for tradition and ancient custom  
 must hope that it will long continue.

This is not the place to write of all the details of marking so  
 carefully recorded and portrayed, which form an important part  
 of the book, but enough has been said to call attention to points  
 of interest in a volume of genuine scholarship. Enquiry into  
 the past history of others of our birds might well be the subject  
 of research by some of our younger ornithologists with the  
 prospect of 30 years before them. A.W.B.

## LETTERS

### INFORMATION WANTED ON LAPWING CHICKS

SIRS,—From observations made over a number of years on the  
 growth and development of young Lapwings (*Vanellus vanellus*),  
 it would appear that early hatching chicks develop more rapidly  
 than later ones. This is not only a matter of general interest  
 but of more particular interest in the case of the Lapwing since  
 taking of its eggs is permitted until 15th April under the Bird  
 Protection Act. If it can be shown that this is acting unfavourably  
 on the species (the longer the fledging period the more likely the  
 chick is to be taken by a predator), then weight is added to the  
 case for amending the law concerning the Lapwing. To prove  
 this point would require several more seasons' observation, but  
 with a little effort ringers could provide the necessary information  
 in the course of one or two seasons.

I should be grateful if you would allow me to ask through your  
 columns for ringers to obtain the following information on as  
 many Lapwing chicks as possible in the 1958 breeding season:

- (1) Hatching date.
- (2) One measurement of the wing (longest primary) in  
 millimetres together with the date of measurement.

It is important that the hatching date is based on observation,  
 not on guesswork. If the actual day is not determined, the last  
 date on which eggs were seen and the first day on which young  
 were seen should both be given, care being taken that these refer  
 to the same birds. The wing should not be measured until the  
 primaries are well clear (10 mm.) of the sheath. The age at which  
 this occurs depends on the rate of development, varying from the  
 18th day in the case of a quick grower to the 34th day for a slow  
 grower. The quick grower will probably not be catchable after  
 the 32nd day; the slowest grower may still be catchable up to  
 the 48th day. This should allow two or three week-ends on which  
 any particular bird can be measured, though in the case of a very  
 slow developer found when too young it may be necessary to catch  
 it a second time a week or so later. It is necessary, of course, for

the chicks to be ringed in order that there is no doubt about the individual's identity. From the data I already possess on the growth rates it will be possible to determine the development of these birds and see if a correlation exists between development rate and time of year.

If anyone wishes more information or would like some hints on finding Lapwing chicks, would they please get in touch with me at 134, Thorntree Road, Thornaby-on-Tees, Yorkshire.

P. A. RAYFIELD

#### "SCIENCE AND THE BIRD-WATCHER"

SIRS,—May I draw attention to one suggestion made by G. L. Scott and D. K. Ballance (*antea*, vol. L, pp. 398-399): that of a "British Bird Report" summarizing interesting occurrences in each county. Now that so many counties publish their own annual reports, many unusual records never reach the general bird-watching public, because they are not rare enough for inclusion in *British Birds* as a separate notice, and because of the impracticability of buying all the reports issued. However, it is usual for the editor of a county report to print a summary of the year's more interesting occurrences as part of his editorial. Surely these summaries could be reproduced, virtually verbatim, in *British Birds*; if small print were used, there would be a saving in space but no loss in legibility. The county reports themselves are published at any time of the year, so that two or three summaries each month as and when they were available would probably do the trick.

A. M. MACFARLANE

SIRS,—Is there just a hint of sour grapes in the letter from G. L. Scott and D. K. Ballance on the above subject?

Whether a paper is on parasites, sub-species, migration or what have you, provided the subject matter is appertaining to birds, either directly or indirectly, then without a doubt it has a place in *British Birds*. It does seem, however, a pity that three or more pages are sometimes taken up with references (e.g. at the end of "The 'invasion' type of bird migration", *antea*, vol. L, pp. 340-343) when space is of primary importance. Would it not be possible to supply the references, to those interested, upon application?

I must confess that a paper on the number of times the young of a species are fed by the parent bird in one particular nest, impresses me little, because it proves nothing beyond the available food supply in that specific district. Furthermore, for some time I have been of the opinion that many bird-watchers, particularly those who take up the hobby because it is now fashionable, become so bogged down with their graphs and statistics that they are blinded to the actual birds themselves.

The mania for counting is an example. On several occasions I have been with other "watchers" who, when a flock of birds is sighted, have immediately commenced furious counting and

re-counting, down to the very last bird, even when the numbers have run into several hundred. Interest in the behaviour of the birds has seemed of secondary importance. Surely this is a pity.

Heaven forbid that *British Birds* should start publishing articles of the "travelogue" type; these can be left to the popular press.

G. L. BOYLE

## REQUESTS FOR INFORMATION

**The 1957 irruptions of tits and other species.**—The organisers report a good response to the earlier appeals (*antea*, vol. L, pp. 495 and 542) for information about the movements of tits (*Parus* spp.) and other birds in the autumn of 1957. For England and Wales this has provided a reasonably full picture of the influx around the coasts, but a rather less complete one of movements and numbers inland. Much less information has been received for Scotland and Ireland, however, and reports (even if negative) of movements, numbers and behaviour from these two countries would be particularly welcome. In addition, details of any movements or changes in numbers during the winter, and of the periods during which paper-tearing, putty-pecking and similar activities were observed (giving first and last dates where possible) are required for the whole of the British Isles. Observations should be sent to Messrs. A. Pettet and J. T. R. Sharrock, Botany Department, University of Southampton.

**Gulls feeding on grain.**—In the very dry harvest of 1955, gulls (*Larus* spp.) made grain their staple diet in one locality in Pembrokeshire, and the tentative conclusion was reached that birds which normally foraged on agricultural land took grain because earthworms and insects were not available to them (*antea*, vol. xlix, pp. 400-404). This conclusion had some support from observations in 1956, a wet season, since gulls were only occasionally seen feeding in corn-fields, but in 1957, also a wet season, they continued to frequent some stubbles until they were ploughed in November. The conditions during harvest were such that much corn was over-ripe when cut and the grain shelled badly. It seems likely that the quantity available may influence the gulls' choice of it as a food.

According to Dr. F. Fraser Darling (1938, *Bird Flocks and the Breeding Cycle*), corn is also eaten by gulls when fields are sown, but no other reference to this in the literature comes to mind. We should be glad, therefore, if reports of gulls feeding in fields of ripe corn or stubbles and in newly sown fields could be sent to Mr. T. A. W. Davis, South Mullock, Haverfordwest, Pems. Observations covering several years would be particularly welcome. Records should include information on the following points: (1) numbers and species involved; (2) whether distribution was widespread or confined to particular fields; (3) kind of grain; (4) whether or not there was proof that grain was being eaten; (5) harvest conditions; (6) when pellets are found at daytime or night roosts, an indication of the number or area involved, an estimate of the proportion of grain pellets, and the nature of other identifiable matter; (7) whether pellets are of whole undigested grain or of husks.

**The place of birds in English folklore.**—An English Folklore Survey has been undertaken in the Department of English, University College, London, under the direction of Professor A. H. Smith, with the assistance of Mr. J. McN. Dodgson. A topic upon which the Survey is now planning to concentrate its attention is that of birds and their place in local livelihood and tradition. Specific points which are to be dealt with are the local, popular names of birds; proverbs, rhymes, etc., in which birds appear; the use of the bird or its egg for clothing, ornaments, cures, foods, etc.; birds figuring in popular belief about good and bad luck, omens, etc.; local beliefs about migration and the weather, and so forth.

The Survey asks interested readers to write to J. McN. Dodgson, M.A., English Folklore Survey, Department of English, University College, Gower Street, London, W.C.1, for fuller details of the scheme.

# RECENT REPORTS AND NEWS

By I. J. FERGUSON-LEES

**The items here are largely unchecked reports, and must not be regarded as authenticated records. They are selected, on the present writer's judgment alone, from sources generally found to be reliable. Observers' names are usually omitted in case a report is subsequently rejected, and none of the items will be mentioned in our annual Index. Readers are asked to submit anything of interest as quickly as possible.**

Last month I suggested that there might be unusual numbers of Shags (*Phalacrocorax aristotelis*) inland. This conclusion seems to have been borne out in the period since then. The occurrence of 20-30 "Shags or Cormorants"—at least two of which, and probably all, were Shags—at Shillington in Bedfordshire, already described, was followed in the next three weeks by reports of 3 single birds, 3 together, 2, 6-7, 6 and 1 in Huntingdonshire; 6 or 7 single ones in Cambridgeshire; and 2-3, 1 and 1 in Buckinghamshire. Then, on 16th February, four Shags were found inside the huge cooling towers of Goldington Power Station, Bedford, and three days later, there were two in the similar towers at Little Barford Power Station, Huntingdonshire: like most, if not all, of the other Shags seen, these were immature birds; enquiries suggested that the four at Goldington had fallen into the towers from a large flock, between 30 and 40 strong, which had perched there. Soon afterwards, there were reports of 2 and 1 elsewhere in Bedfordshire and then, on 22nd February, a total of 24 Shags was reported flying north at Southill, Bedfordshire, towards the county town; by this time there were 3 at Cambridge. In addition to this remarkable concentration in Bedfordshire and the neighbouring counties, about 6 were reported in Essex, a total of 9 in Surrey, 7 dead together in Kent and a scattering in other counties from Wiltshire (apparently the first record for some 30 years) round to Norfolk and Lincolnshire; more than usual were also seen on the south-east coasts. Ringed Shags were recovered in Essex, Kent, Cambridgeshire, Huntingdonshire, Norfolk and Lincolnshire, and these were all first-winter birds from the Farne Islands, the Bass Rock and the Isle of May. One or two ringed immatures from these areas are recovered inland each winter, but this year's numbers seem quite abnormal and we should be grateful for any further reports which might help to throw light on the general picture. At the moment the evidence suggests that an unprecedented quantity of mainly immature Shags, from N.E. England and S.E. Scotland, have turned inland, probably at the Wash, and become disorientated. I am very grateful to Mrs. J. B. Cowdy and Messrs. D. K. Ballance, H. A. S. Key, Robert Spencer and C. F. Tebbutt, who between them have provided most of the information on which this paragraph is based.

Another remarkable occurrence was the appearance near Waldringfield in Suffolk, probably on 9th or 10th January, of 5 Cranes (*Grus grus*). It was not until three weeks later that they were seen by ornithologists and by that time there were only 4 (2 adults and 2 first-winter) which, however, remained in Suffolk until the end of February. It seems possible that these were the remnants of a party of 6 which spent from 17th November to 7th December at North Deighton, near Wetherby, Yorkshire—particularly as a sixth Crane was found in East Anglia on 20th February. Injured by wires at Earls Colne, Essex, this was handed to the R.S.P.C.A. and released on the 28th. If the assumption of one wintering group is correct, it is to be wondered where they were for the six weeks between their departure from the Yorkshire locality and their arrival in Suffolk. It should perhaps be remembered that the Crane was a regular winter-visitor to England for 100 years or more after it ceased to breed about 1600.

The bulk of the rest of the interesting reports, as one might expect at this time of year, concern wildfowl and gulls. An adult male Lesser Scaup (*Aythya affinis*) was reported from Barn Elms reservoir, Surrey, from 8th to 12th February and later (one assumes the same bird) from Richmond Park, Surrey, on the 16th. At this time the other reported Lesser Scaup was still present in Berkshire, as was the even more problematical bird in Gloucestershire (see *antea*, p. 40). It must be stressed that the identification of all these Lesser Scaups is still somewhat hypothetical and it is even possible that they may be hybrids between Scaup (*A. marila*) and Tufted Duck (*A. fuligula*).

A Red-breasted Goose (*Branta ruficollis*) was identified near Amberly in Sussex, on 8th February, with a flock of 112 White-fronted Geese (*Anser albifrons*), and it remained there until the 15th. The first Lesser Whitefront

(*A. erythropus*) to be seen at Slimbridge, Gloucestershire, this year (*cf. antea*, p. 84)—an adult—was reported on 11th February, and the Kirkcudbrightshire one was seen again on 8th and 25th February. Also, a third—a first-winter bird—was identified in Norfolk on 19th January. This last was with 72 Bean Geese (*A. arvensis*) and 5 Whitefronts at the locality where one was seen in 1956 (*antea*, vol. xlix, p. 228), a regular wintering area of Bean Geese. Bean Geese are not regular in Somerset, however, and so a report of two at Chew Valley reservoir, from 2nd February until at least the 9th, is noteworthy. There is one more goose report which should be mentioned here, as a continuation of a story which began a year ago: in February 1957 one bird among a flock of Dark-bellied Brent Geese (*B. b. bernicla*) in Essex was identified as being of the distinctive western North American and east Siberian race (*B. b. nigricans*)—known as the Pacific Black Brant. This is an even darker-breasted, darker-backed form than *bernicla*, with an almost complete white collar. On 8th February this year what was presumably the same bird was reported again from the same place, again with Dark-bellied Brents. Enquiries have suggested little likelihood of escape from captivity.

The subject of Long-tailed Ducks (*Clangula hyemalis*) inland continues to crop up (*cf. antea*, p. 40 and 84) and to the instances already reported must be added the single birds seen in Kent and Buckinghamshire from 17th November in each case (the Kent bird staying until 1st December) and, most remarkable of all, a party of no less than 6 near Nottingham on 10th November; in addition, there were 3 on Lake Windermere, Westmorland, from 18th February until at least 1st March, where there had been 2 previously (see *antea*, p. 84). Thus we have a total of nine counties that have reported inland Long-tailed Ducks this winter: a proper summary will be published in a forthcoming issue. With reference to the enquiry into the status of the Red-crested Pochard (*Netta rufina*) (*antea*, vol. L, p. 543), it might be added that single ones have been reported from Lincolnshire (November), two localities in Sussex (December-February), Roxburgh (December) and Co. Meath (January); the last report from Abberton, Essex, this winter was of one on 22nd December. Ferruginous Ducks (*Aythya nyroca*) are, it seems, less commonly kept in captivity at the present time than they were formerly, and so it is possible that a drake near Grantham, Lincolnshire, during 25th-27th December was a wild bird.

Before leaving the subject of wildfowl, this is perhaps an opportune moment to give a warning concerning the North American Ruddy Duck (*Oxyura jamaicensis*). This species has, so Mr. Peter Scott tells us, been breeding extremely successfully at Slimbridge and it is often impossible to capture and pinion the young birds. As a result, a number have escaped and have been reported from various parts of the country. The adult male is very distinctive, but the females and juvenile males are very similar in general pattern to the corresponding plumages of the White-headed Duck (*O. leucocephala*) of southern Europe, which is, however, larger and has a swollen base to the bill: on at least three occasions this winter this similarity has caused users of the *Field Guide* to mistake Ruddy Ducks for White-headed Ducks.

Adult Mediterranean Black-headed Gulls (*Larus melanocephalus*) have been reported from near Lowestoft, Suffolk, since 17th October, and from the Hove/Shoreham area, Sussex, since 5th February. Both were still present in mid-February. A second-winter Iceland Gull (*L. glaucoides*) has been seen regularly in the latter area since 24th January, the first winter record of this species in Sussex since 1931.

The immature White-tailed Eagle (*Haliaeetus albicilla*), already referred to in this series (*antea*, pp. 40 and 84), was reported on several dates in February from various localities in Norfolk, most recently from Cley on 4th March. There were also reports of what may prove to be a White-tailed Eagle (? the same) from three places in Suffolk in January and February.

Passerines have been little in the news, though small parties of Waxwings (*Bombycilla garrulus*) continue to be reported from various parts of the country and quite a number seem to have reached Ireland, where Mr. G. R. Humphreys tells us that he has had reports from Cos. Dublin, Down, Kilkenny, Sligo, Tyrone and Wexford. A Firecrest (*Regulus ignicapillus*) was identified near Aymestrey, Herefordshire, on 16th February, in which part of the country this species is very seldom recorded. Finally, three reports from the Kent and Norfolk coasts, and possibly also from Hampshire, suggest that there was an interesting influx of Stonechats (*Saxicola torquata*), particularly cocks, in S.E. England on 16th February: further information would be useful.

2 MAR 1958



## NOTICE TO CONTRIBUTORS

*British Birds* publishes material dealing with original observations on the birds of Britain and Western Europe, or, where appropriate, on birds of this area as observed in other parts of their range. Except for records of rarities, Papers and Notes are normally accepted only on condition that the material is not being offered to any other journal. Photographs (glossy prints showing good contrast) and sketches are welcomed. Proofs of all contributions accepted are sent to authors before publication. After publication 20 separates of Papers are sent free to authors; additional copies, for which a charge is made, can be provided if ordered when the proofs are returned.

Contributors are asked to observe the following points, attention to which saves the waste of much editorial time on trivial alterations:

1. Papers should be typewritten with double spacing, and on one side of the sheet only. Shorter contributions, if not typed, must be clearly written and with similar spacing. Failure to help in this way may result in delays to publication.

2. Notes should be worded as concisely as possible, and drawn up in the form in which they will be printed, with signature in block capitals and the writer's address clearly written on the same sheet. If more than one Note is submitted, each should be on a separate sheet, with signature and address repeated. In the case of rarity records, any supporting description which is too detailed for publication should be attached separately.

3. Certain conventions of style and lay-out are essential to preserve the uniformity of any publication. Authors of Papers in particular, especially of those containing Systematic Lists, Reference Lists, Tables, etc., should consult the notes in this issue as a guide to general presentation. English names of species should have capital initials for each word, except after a hyphen (e.g. Siberian Thrush, Yellow-headed Wagtail), but group terms should not (e.g. thrushes, wagtails). English names are those used in *The Handbook of British Birds*, with the exception of the changes listed in *British Birds* in 1953 (vol. xlvi, pp. 2-3). The scientific name of each species should be given (in brackets and underlined) immediately after the first mention of the English name. Sub-specific names should not be used except where they are relevant to the discussion. It is sometimes more convenient to list scientific names in an appendix.

Dates should take the form "1st January 1955" and no other, except in Tables where they may be abbreviated to "1st Jan.", "Jan. 1st", or even "Jan. 1", whichever most suits the lay-out of the Table concerned. It is particularly requested that authors should pay attention to Reference Lists, which otherwise cause much unnecessary work. These should take the following form:

TUCKER, B. W. (1949): "Species and subspecies: a review for general ornithologists". *Brit. Birds*, xlii: 129-134.

WITHERBY, H. F. (1894): *Forest Birds: Their Haunts and Habits*. London. p. 34.

Various other conventions concerning references, including their use in the text, should be noted by consulting previous examples.

4. Tables should be numbered with Roman numerals, and the title typed above in the style used in this issue. The title and any headings within the Table should not be underlined, because this sometimes makes it difficult for the Editor to indicate the type to be used. It is most important that the lay-out of each Table should be carefully planned with an eye to its final appearance; above all, it should be borne in mind that Tables must either fit into the width of a page, or be designed to fit a whole page lengthways. All Tables should be self-explanatory.

5. Figures should be numbered with Arabic numerals, and the captions typed on a separate sheet. All line-drawings should be in Indian ink on good quality drawing paper (not of an absorbent nature) or, where necessary, on graph paper, but this must be light blue or very pale grey. It is best if maps, graphs, etc., are drawn twice the size of the final reproduction (ideally, therefore, for the normal 4" width the original should be 8" wide); sketches of birds, however, should be only slightly larger than the size at which it is intended they should appear. It is always most important to consider how each drawing will fit into the page. The neat insertion of lettering, numbers, arrows, etc., is perhaps the most difficult part of Indian ink drawing and, unless he has had considerable experience of this kind of work, an author should seek the aid of a skilled draughtsman. The publishers regret that, owing to rising costs, it will in future be only in exceptional cases that they can undertake to have lettering inserted.

Captured German Stores

**LEITZ**

(of Leica fame)

**10 X 50 Eyepiece Focusing  
BINOCULARS**

**The ideal glass for the  
BIRDWATCHER**



An extremely well made instrument combining high magnification with good light transmission. Weight 2 lbs. Current cost approx. £60. Excellent condition, with leather case

**£26**

*We have specialised in fine quality binoculars and optical equipment for half a century and carry Europe's greatest stocks of ex-Govt. binoculars. Every purchase is covered by our money-back guarantee, and if requested, will be sent on 7 days free approval, Credit terms available if desired.*

**GERMAN ARMY  
BINOCULARS**

**6 X 30**

Best makes. Eyepiece focusing. Weight only 14 ozs. Shock- and water-proofed. With all-weather case. Fraction of cost

**£7 15s. 0d. to £10 15s. 0d.**

**EX-ADMIRALTY ROSS 16 X 40  
SINGLE DRAW TELESCOPE (Micrometer Focusing)**

The Ross telescope is famous throughout the world and this model, produced to exacting Admiralty standards, combines an extremely high light transmission with a wide field of view. Length closed 11", fully extended 17½". Focusing is achieved by specially quick micrometer system. Of all the Admiralty scopes this is the lightest, being only 28 ozs. in weight. These telescopes are offered at well under half cost price. Almost mint condition.

**£5 . 18 . 6**

**POSTAGE 2/6**

**CHARLES FRANK**

**67-73 SALTMARKET, GLASGOW, C.I.**

Telephone : **BELL 2106-7**

**Established 1907**



# BRITISH BIRDS



APRIL 1958

THREE SHILLINGS

# BRITISH BIRDS

AN ILLUSTRATED MONTHLY MAGAZINE

Edited by

E. M. NICHOLSON

W. B. ALEXANDER                      A. W. BOYD

I. J. FERGUSON-LEES

P. A. D. HOLLON                      N. F. TICEHURST

*Editorial Address* : 30, St. Leonard's Avenue, Bedford.

*Photographic Editor*: G. K. YEATES

Annual Subscription £2 (including postage and despatch)

payable to H. F. & G. Witherby Ltd., 5, Warwick Court, London, W.C.1

---

## CONTENTS OF VOLUME LI, NUMBER 4, APRIL 1958

---

	PAGE
Telescopes and binoculars: some recent improvements in design and their value for bird-watching. By E. M. Nicholson. Sketches by Robert Gillmor ... ..	133
Observations on the feeding of the Oystercatcher in captivity. By R. E. Drinnan ... ..	139
Photographic studies of some less familiar birds. LXXXVII—Scops Owl. Photographed by K. Koffán (plates 25-28). Text by I. J. Ferguson-Lees ... ..	149
Waders at ocean weather-ships in 1956. By Ivor McLean and Kenneth Williamson ... ..	152
Notes:—	
Fish-hook in Heron's pellet (Eric Hosking) ... ..	156
Merlins at sea (Ivor McLean and Kenneth Williamson) ... ..	157
Variant leg and bill colour of the Moorhen (Bryan L. Sage) ... ..	158
White-winged Black Tern in Lincolnshire (D. G. H. West and P. B. Haywood) ... ..	159
Wing-winged Black Tern in Kent (Rev. A. C. Cawston) ... ..	160
White-winged Black Tern in Sussex (Gerald A. Sutton) ... ..	160
The song-period of the Woodpigeon in Flintshire (L. S. V. Venables and U. M. Venables) ... ..	160
Letters:—	
Flatflies wanted (D. S. Hill) ... ..	161
"Information wanted on Lapwing chicks" ... ..	161
Requests for Information:—	
The 1957 irruptions of tits and other species: interim report (S. Cramp, A. Pettet and J. T. R. Sharrock) ... ..	162
Field investigations of the B.T.O. ... ..	163
Recent reports and news. By I. J. Ferguson-Lees ... ..	164

---

Cover photograph by G. K. Yeates: male Snow Bunting (*Plectrophenax nivalis*)

VOL. LI  
No. 4

APRIL  
1958



## BRITISH BIRDS

---

### TELESCOPES AND BINOCULARS : SOME RECENT IMPROVEMENTS IN DESIGN AND THEIR VALUE FOR BIRD-WATCHING

By E. M. NICHOLSON

FIELD-ORNITHOLOGY owes much to modern optical aids, but until very lately the improvement has been concentrated almost entirely on binoculars. Telescope-makers appeared to cling to the belief that what was good enough for Nelson was quite good enough for them. As recently as 1950, in writing the original edition of the British Trust for Ornithology's Field Guide "How to Choose and Use Field-Glasses", the present writer felt compelled to observe:

"It is evident to anyone who glances at a party of ornithologists trying to use telescopes on a mud-flat that sooner or later either the telescope or the bird-watcher will have to be entirely redesigned. The former would be more convenient".

With a single partial exception, these words have so far fallen on deaf ears in Great Britain. Optical manufacturers in Switzerland, Germany, the United States and elsewhere are, however, now producing instruments of really modern design and performance which are, in some cases, obtainable in this country. I have used one of these telescopes for nearly a year and have tried four other makes. These tentative notes are offered as a stimulus to further discussion and experiment about the best optical equipment for modern field observation.

Bird-watchers seek a strong and light instrument to show them the distant bird as if it were close and the dim feature as if it were clear. They want to be able to watch birds far enough away to identify and study them without disturbing them; also to save time and mileage by examining them at a distance across open country or water, especially where access is difficult.

Modern general-purpose binoculars, magnifying 6 to 9 times are unmatched as basic equipment. They normally weigh only about 14-21 oz., and can be carried and used all day without fatigue or eyestrain. They can be quickly aimed and focussed and steadily held on fast-moving targets by a reasonably practised observer. Their fields of view at 1,000 yards are normally from about 120 to 160 yards across, permitting simultaneous watching of scattered flocks in the air or on the water. At closer range they allow tits and warblers to be spotted as they move about in foliage. Their exit pupils of some 3.8-5 mm. transmit most of the light which the average bird-watcher can use. The better instruments give remarkably clear definition and resolution of detail, although colours are naturally not well distinguished in the poorer lights. The stereoscopic image is also helpful. With all these merits a good general-purpose binocular costs much the same initially as a good camera, but, unlike a camera, costs nothing to use almost indefinitely.

Yet the exacting requirements of many observers are not fully met by such binoculars. This is proved by the numbers of higher-powered and heavier instruments in use. The binocular-makers have shown much enterprise in designing glasses giving 10 $\times$ , 12 $\times$ , and even 15 $\times$ , 16 $\times$ , and 18 $\times$ . Yet these relatively modest increases in magnification have been achieved at a heavy cost, not only in additional price but in reduced performance and convenience in almost every other respect. Weights are normally increased to between 30 and 50 oz., which makes them equivalent to carrying a hen Pheasant slung from the neck. Fields of view shrink to maxima of around 120 and minima of less than 70 yards at 1,000. Exit pupils are maintained at around 4 mm. only by massive increase in bulk, not only of the instrument but of its carrying case, which alone may add as much weight as a light general-purpose glass complete with case.

Though fit and strong-armed observers may find such cumbersome and specialized binoculars worth while, they have two drawbacks which are beyond argument. Almost all of them have magnifications below 20 $\times$ , yet it is in the range between 20 $\times$  and 30 $\times$ , rather than between 10 $\times$  and 20 $\times$ , that the field observer's requirements for higher power begin to be fully satisfied. The second drawback is the difficulty, for all but the most exceptional user, of avoiding the sacrifice, through wobble, of most of the advantage of powers above 9 $\times$ , in instruments which do not lend themselves to convenient use with a stand. This can be mitigated, in some circumstances only, by lying flat or resting the elbows on a wall or post.

It is here that the new redesigned telescopes score. Their magnifications are similar to those of traditional models, ranging from a fixed 20 $\times$  to variable ranges of 20-40 $\times$  or 25-50 $\times$ . They are, however, much lighter and more compact. Whereas weights of 50-90 oz. and extended lengths of about 30-42 inches presented

the user of the more powerful traditional telescopes with the problem of looking through something roughly the length and weight of a Cormorant, modern designs achieve powers of 20-50 $\times$  at weights of 10-24 oz. and with fully extended lengths from as little as 8½ to no more than 24 inches. This is roughly the same weight range as that of the light-weight general-purpose binoculars, which means that both carried together are still lighter than most binoculars of 10 $\times$  or over. Built-in bushes are provided for use with a stand if desired. Coated lenses, and in some cases prismatic construction, give a much brighter image and better definition than the old-fashioned telescope. Object-glass diameters are normally between 40 mm. and 60 mm. The exit pupils are thus inevitably in the low range 1-3 mm., according to design and power used, but it is only in really poor lights that lack of illumination is a serious handicap, and recourse to lower-powered binoculars becomes preferable. The other main and inherent drawback of the modern telescope is, of course, the narrow field of view, ranging from about 50 yards at 1,000 yards (or more often 20-35 yards) at lower powers to as little as 11 yards for a magnification of 50 $\times$ . The prices of these telescopes are no more than, and usually well below, those of new general-purpose binoculars by first-class makers, three at least being under £28, and therefore roughly comparable with conventional telescopes of similar magnification ranges and exit pupils.

In most outdoor activities, from motoring to photography, a choice has to be faced between all-round and specialized equipment. The urge to try and combine both is universal, but, however ingenious the designs, there comes a point where satisfaction of the basic simple requirement is endangered by the effort to meet more advanced or specialized needs. In binoculars it seems that this dilemma arises when the magnification is raised above 9 $\times$  and the object-glass above 40 mm., or thereabouts. From then on, bulk and weight and price rise more steeply, while handiness, light transmission and field of view dwindle. Faced with the discouraging alternative of conventional telescopes it seemed worth endeavouring to extract even a little more power from binoculars. Given the new alternative of the redesigned telescope the balance has tipped over. Where differing requirements and personal idiosyncracies count for so much it is unsafe to say more than that those who are contemplating the purchase of expensive binoculars of 10 $\times$  or above would be well advised to look first at the alternatives.

The new telescopes have largely triumphed over the old disadvantages of excessive weight and length, indistinctness of image, difficulty of focussing and unduly poor illumination. They still suffer from narrowness of field and lack of stereoscopic power. Some of them have the unexpected advantage of allowing focus down to ranges of as little as five or ten yards, which can be useful for such purposes as reading ring numbers at bird-tables

or inspecting nests on cliff-ledges, the magnification at such distances giving an image larger than life-size.

It is not, therefore, for distant work only that such powerful instruments can be invaluable. Much natural and spontaneous bird behaviour is lost to the normal observer who has to move up in full view close enough to see details through binoculars. Use of a hide or careful stalking can, of course, overcome this inhibiting effect on the birds, but only at the cost of losing much that goes on at a distance. Detailed behaviour, such as feeding and display, and finer points of plumage or soft parts can often be studied with ease by telescope but with difficulty, if at all, by other means. For longer ranges the telescope has not only the well-known advantages of permitting distant identification and counting, but the less obvious one of quickly eliminating a number of doubtful or problem objects which would otherwise take time that could be spent on more interesting observations.

As already stated, the new telescopes are either of fixed power, usually  $20\times$ , or variable with a range from  $20\times$  or  $25\times$  to  $40\times$  or  $50\times$ . In British conditions the most useful powers are  $20\times$ ,  $25\times$  and  $30\times$ . Occasions when there is real advantage in going above  $35\times$  are in most places so rare as to be negligible. Above that power not only is even slight vibration troublesome, but any shimmer in the air can make it almost opaque, especially when the sight-line passes low over water or marshy ground. Looking from mountain-top to mountain-top in clear air downsun, or examining prey in an inaccessible eyrie at fairly close range are examples of the rather rare conditions when  $40\times$  or  $50\times$  are of unquestionable value. The depth of focus, however, becomes extremely shallow at such powers, and the angle of view restricted. Normal practice should be to keep the instrument at its lowest magnification unless and until a subject calling for higher magnification is in view.

While low-powered binoculars are nearly fool-proof, telescopes, being specialized and powerful instruments, cannot be satisfactorily used without first taking trouble to learn how. Although in fair conditions the modern light telescopes can be used in the hand at  $20\times$  or  $25\times$ , a stand or support is strongly to be recommended for better resolution of detail. Even with binoculars most observers lose much more than they imagine through shake, as can easily be proved by looking at the same object first without using a support and then with the binoculars resting on some fixed base, such as a post.

Some observers favour a short bipod or tripod to hold the instrument at a height of about 16 inches for use in lying position, suitable for long-range stalking. Others, especially in America where spotting telescopes are in widespread use, favour an ultra-light tripod with collapsible or non-collapsible legs up to some 60 inches long, and a ball-and-socket to adjust the angle of view in any plane or direction. It is impracticable to discuss here all the pros and cons of different types of tripod, but the reader should

be warned that careful selection is necessary since many of those on sale are either uncomfortably heavy to carry or, if light, are insufficiently rigid; others are very vulnerable to rust damage after wetting unless immediately greased. Here again it is regrettable to have to record that both American and Continental designers seem to have met the need better. The problem may arise of fitting an English to a Continental thread; adapters for this are easily obtainable.

For those who find a tripod too cumbersome, an ingenious alternative now available is the NS Unipod, a telescopic tubular stand. This weighs only 14 oz. and when closed makes a good light walking-stick adjustable to any length; when fully opened it gives a remarkably firm and rigid 64-inch-high stand with a 2-inch platform on which either a telescope or camera can quickly be screwed in place of the round handle. If correctly held (see Fig. 1), with one hand above the middle of the telescope and the other as far as is convenient down the stand, it is practically as steady as a normal tripod; Fig. 2 illustrates a more obvious but more shaky hold, with one hand unnecessarily gripping the eyepiece, which is already sufficiently steadied against the brow. It is most important to learn the most comfortable and steadiest hold for a telescope.

When closed (see Fig. 3) the Unipod enables the telescope to be held more steadily with the two hands well apart in an easy position, and in this way birds such as crows and gulls can be followed in flight, although faster and more erratic fliers such as ducks are difficult.

Some telescopes are calibrated on the barrel to show correct positions for infinity focus at each magnification. Where there are two draws, the first should always be fully opened, the second (bearing the eyepiece) being adjusted with a spiral motion—towards the eye for nearer subjects and away from it for more distant ones—until sharp focus is reached. A straight pull often overshoots the correct position. Approximately correct focus must precede target-finding, and unless the target is large or readily distinguishable it saves time to focus first on a shore-line, building, flock of birds or other larger object at about the same distance. Although seeing things through one eye at least twenty times larger than the other may look odd, it can be helpful to keep the spare eye open at first, to check that direction is correct. It perhaps needs to be added that some people see nothing at all as a result of jamming the telescope right into the eye; the correct distance is about that of spectacles, which indeed need not be removed unless they are admitting too much unwanted light from the side.

These notes are simply pointers to help those who have to familiarize themselves with ways of getting from modern telescopes the excellent results which they can yield only if properly handled. Good as they are for many purposes, they are of course quite un-

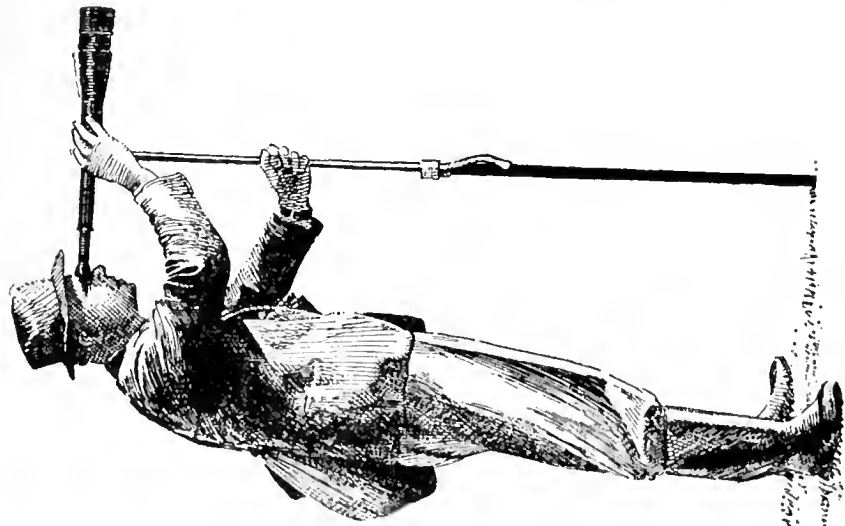

Fig. 1

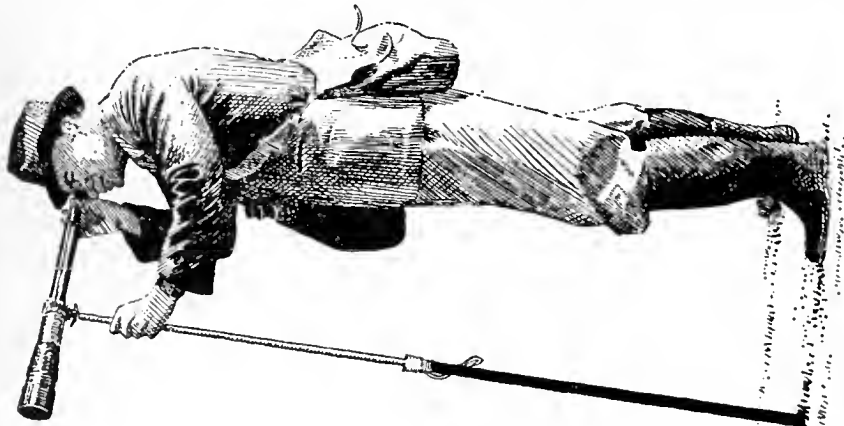

Fig. 2

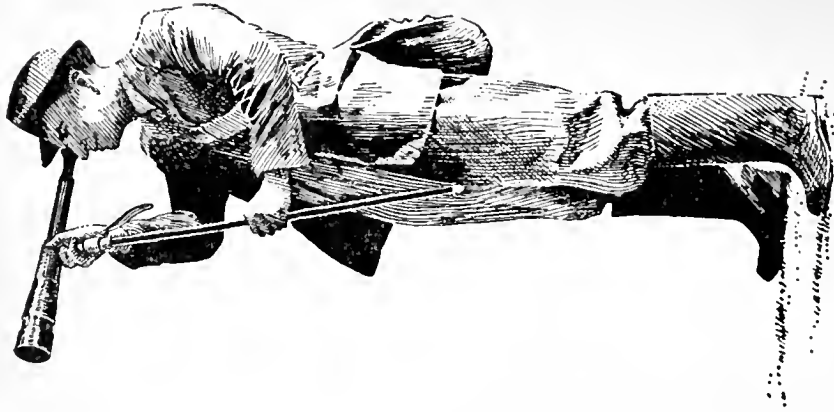

Fig. 3

SKETCHES TO SHOW THE USE OF THE N.S. UNIPOD, AN EXTENDING TUBULAR STAND FOR TELESCOPES AND CAMERAS  
 (Drawn by Robert Gillmor from photographs by E. M. Nicholson)

This telescopic stand weighs only 14 oz. and is adjustable to any length from 34 to 64 inches. Fig. 1 illustrates the steadiest hold for a telescope, one hand on the middle of the instrument, the other well down the stand, and Fig. 2 shows an incorrect and more shaky method with one hand unnecessarily gripping the eye-piece; Fig. 3 demonstrates how the closed stand can make possible the use of a telescope for birds in flight (see page 137).



suitable for such uses as watching small restless birds in dense cover, or keeping a look-out for something flying over. They do, however, enable a really light handy binocular to be used as the everyday first-line instrument with the confidence that when much higher powers are needed they can quickly be substituted if one is carrying a light modern telescope as supplementary equipment; and the total weight, of binoculars, telescope and stand can be kept to below 5 lbs.

No doubt a number of new designs will be produced, and it is to be hoped that British manufacturers of telescopes and stands will soon be offering a satisfactory range, able to compete with those now being imported here and with others not at present obtainable in this country. In present circumstances it would be difficult and invidious to give a list of models on the market, with their specifications and prices, but all the necessary data for making a personal selection have been given above.

There is not room to name here the many whom I have to thank for suggestions and advice about the preparation of this brief review, but I cannot refrain from acknowledging specially the expert help of Mr. J. R. Hebditch, who was good enough to take over from me the responsibility for the revised edition of the British Trust for Ornithology's Field Guide "How to Choose and Use Field-Glasses". Any comments, criticisms and suggestions received will be passed on to him and I hope that they may in due course be embodied, for the general benefit of bird-watchers, in a further revised edition of that Field Guide which, I understand, is likely to be produced within about a year.

## OBSERVATIONS ON THE FEEDING OF THE OYSTERCATCHER IN CAPTIVITY

By R. E. DRINNAN

(*Fisheries Experiment Station, Conway*)

ESTIMATES of the food intake of the Oystercatcher (*Haematopus ostralegus*) have been made in the field in the past three years (Drinnan, 1956, 1957). These have yielded results consistently higher than food intakes reported in the literature from both field and laboratory studies. A possible source of error in our calculations was the assumption that feeding continued at night at the same rate as observed in daylight. For this reason a study of the food intake of captive birds was initiated at the Fisheries Experiment Station at Conway, Caernarvonshire.

### METHODS

The birds used were selected from a wild stock netted for ringing. Immediately after capture they were closely examined for any damage and put into cages of stout wire mesh, 40 × 20 ×

20in. These cages were housed in a naturally illuminated laboratory cellar. Mussels (*Mytilus edulis*) were provided on a tray of sand or gravel on the floor of the cage. The bottom of the cage was of the same material, stout wire of 1in. mesh, as the sides and top.

Periodically the cages were inspected, and any opened and cleaned mussels were removed, measured and counted. Every day the cages were scrubbed with disinfectant and fresh absorptive material was placed beneath them.

All the mussels fed to the birds in the experiments described were from the same population. A sample of 200 of these mussels, in groups of ten at one millimetre length intervals, was used to obtain a relation between length of shell and volume of contained meat. The meat of these was removed, dried on a cloth and measured by displacement of water. From the resulting graph mean values of meat for each millimetre length-group were obtained, and these were used to calculate the meat volume of the mussels eaten by the birds. In the measurement of eaten mussels any which had been so damaged by the birds that measurement was impossible were added to the mean size-group.

Additional observations were made on an Oystercatcher at Seahouses, Northumberland. The food of this bird was limpets (*Patella*): it had been picked up with a damaged wing a year earlier, and was allowed the freedom of a small walled garden, predominantly of grass. Limpets and trays of freshwater were always available. At the beginning of the period of observation all the open limpet shells were removed from the enclosure and all shells cleaned subsequently were removed at 24-hour intervals. The individual meat volume of limpets was related to shell length for a sample of the limpets fed to the bird.

## RESULTS

### (a) Conway

#### *Food intake.*

The feeding experiments at Conway were designed to serve a dual purpose. Together with the measurement of the food intake of the birds a preliminary investigation was made of food preferences. The weight of the birds often showed marked fluctuations with different foods. For this reason the data used here in the estimation of food intake are those obtained from two birds which were under observation for a period of six days in December 1956, during which their weights were approximately constant on a diet of mussels from a standard population.

The observations on these birds, coded B and W/B, were started one week after they were brought into the laboratory. In this period they had regained an initial loss in weight (which was normal for birds brought into the laboratory) and were feeding well, though still very sensitive to human interference. In Table I and Fig. 1 the food intakes and weights of the two birds for

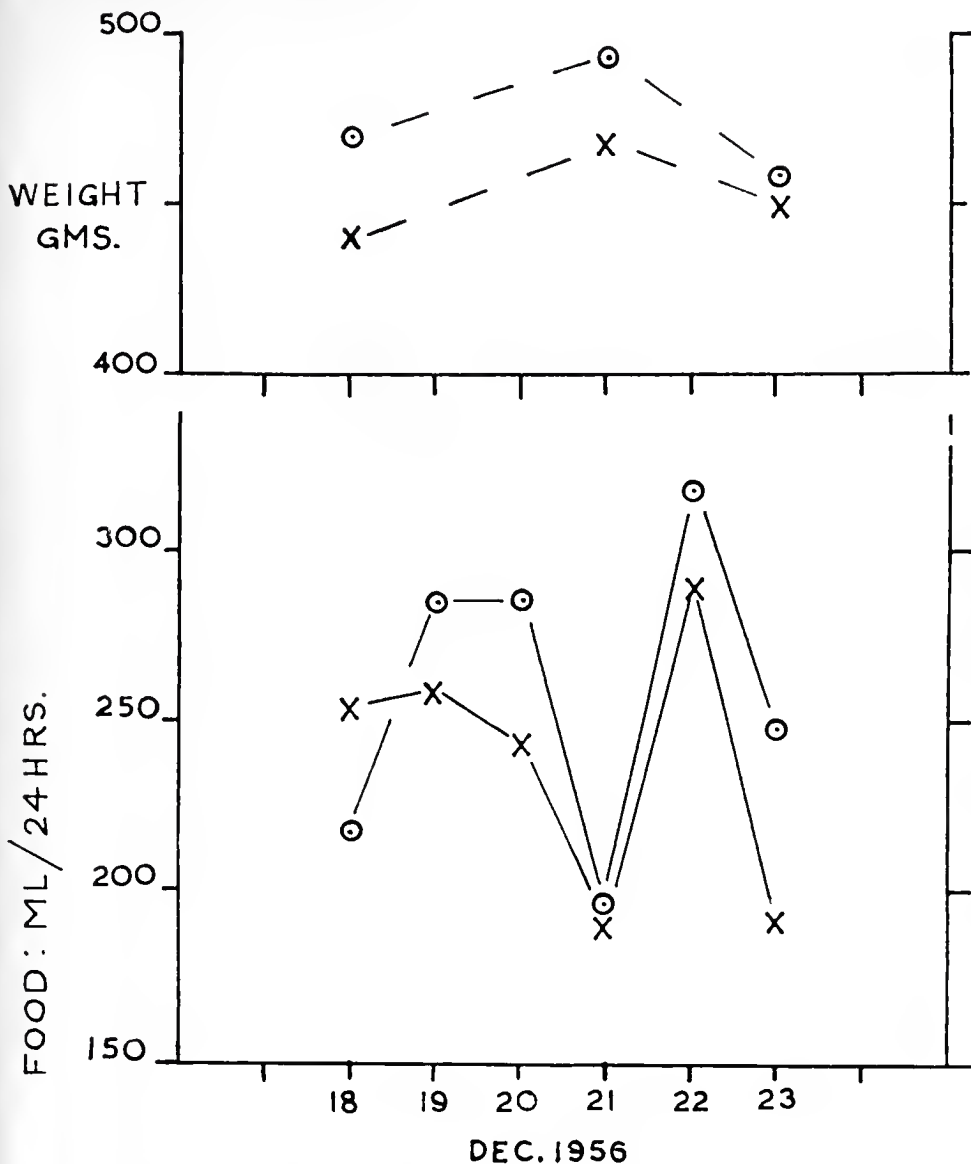

FIG. 1—DAILY FOOD INTAKE, AND CORRESPONDING WEIGHTS, OF TWO CAPTIVE OYSTERCATCHERS (*Haematopus ostralegus*): 18TH-23RD DECEMBER 1956. The two birds were coded B and W/B (see page 000 and Table I); and here B is indicated by the cross, W/B by the dot and circle. The food was mussel meat (*Mytilus*), and the intake is expressed in millilitres (= cubic centimetres) per 24 hours.

the period 18th-23rd December 1956 are shown. Large fluctuations occurred in the daily food intakes of both birds and these cannot be explained. Attempts were made to standardize the period of human interference necessary when weighing or feeding as the effect of any intrusion was marked. It is unlikely that this interference had any importance as the most marked variations occurred on days when the laboratory was empty. It is interesting to note that the birds showed very similar fluctuations;

W/B ate more than B on every day except the first day of observation. Other consistent differences will be noted later.

TABLE I—FEEDING RATES OF TWO OYSTERCATCHERS (*Haematopus ostralegus*) IN THE FISHERIES EXPERIMENT STATION LABORATORY AT CONWAY, CAERNARVONSHIRE

The two birds were coded B and W/B. In each case the total daily intake of food is expressed in millilitres (= cubic centimetres) per 24 hours; and, in addition, the average intake per hour, in millilitres, is given for the two periods dawn to dusk and dusk to dawn. The birds were weighed (in the afternoon) on several days during the experimental periods and these figures are included in the last column.

Date	ml./24 hr.	Day ml./hr.	Night ml./hr.	Wt. of bird (gm.)
<b>B</b>				
18 Dec. 1956	254	22.0	6.7	440
19 " "	259	14.0	9.8	
20 " "	244	12.6	9.4	
21 " "	190	17.1	5.1	468
22 " "	289			
23 " "	190			448
Mean	237.6	16.5	7.7 (46.6% day)	
<b>W/B</b>				
18 Dec. 1956	217	19.5	5.6	468
19 " "	284	15.6	10.6	
20 " "	285	15.0	10.8	
21 " "	195	13.0	6.5	492
22 " "	317			
23 " "	246			457
Mean	257.3	15.8	8.4 (53.1% day)	
27 Dec. 1956				398
28 " "	394	22.9	13.8 (60.3% day)	443
29 " "	293			
30 " "	327			421
31 " "	439			495
1 Jan. 1957	342			465

The birds were weighed three times during the experimental period. The variations in weight are believed to have resulted largely from differences in the gut contents of the birds when weighed. Though the weighings were standardized in so far as they were made when the birds were fed in the afternoon, there was no guarantee that the birds showed consistency in their feeding habits before weighing. (Other Oystercatchers weighed after being deprived of food for two hours showed a drop in weight of 20-30 gm., equivalent to the variation in the weights of the experimental birds.) W/B was consistently heavier than B. If the mean food intake per 24 hours is divided by the mean weight the results show good agreement.

$$B \quad \frac{237}{451} = 0.525 \text{ ml./gm./24 hr.}$$

$$W/B \quad \frac{257}{472} = 0.544 \text{ ml./gm./24 hr.}$$

*Effect of loss of weight on food intake.*

After the experimental period of six days the birds were given other foods. This resulted in a big weight loss. On 27th December W/B weighed only 298 gm. and was returned to its former mussel diet. In the next five days (Fig. 2), the bird regained its former weight; food intake showed a great increase over the period 18th-23rd December, reaching a maximum of 439 millilitres (= cubic centimetres) per 24 hours on the 31st December.

*Comparison of day and night feeding.*

For the first four days of the period 18th-23rd December, the food intake was measured (Table I) for the two periods dawn to dusk and dusk to dawn. In the dark both birds ate at approximately half the rate of daylight hours. On 28th December the food intake of W/B was again split into the two periods (Table I) and showed the same relationship between day and night feeding. However, though the rate of feeding in darkness on 28th December was still only 60% of that by day, it was almost equal to the rate of feeding by day in the period 18th-22nd December.

During the period 18th-23rd December the moon was waning from a full moon on the 17th, but the cellar where the birds were housed was in almost total darkness. On the 28th, four days after the last quarter, the moon rose at 05.30 hours so the birds were in complete darkness.

*Food and feeding behaviour.*

The mussel population on which the birds fed ranged from 30 to 50 mm. in length. The size-distribution of the opened shells showed no selection within this size range.

The method of opening the shells was difficult to observe directly owing to the extreme sensitivity of the birds. Mussels opened on the trays were attacked ventrally, the typical approach in the field (Drinnan, 1958). Orientation in this position, with the ventral edge of the shell uppermost, was difficult on the cage floor, especially with the larger mussels. The most stable position, which allowed access to the valve edges, was with the anterior of the shell wedged in the mesh of the cage floor. Most of the shells opened on the cage floor were opened in this position, access being gained through the posterior border.

## (b) Seahouses

*Food intake.*

Three collections of emptied limpet shells were made at 24-hour intervals on 3rd, 4th and 5th April 1957, and a final collection soon after dawn on the 6th.

The three 24-hour periods gave results of 321, 271 and 180 millilitres (= cubic centimetres) of meat eaten with a mean of 10.7 millilitres per hour. The feeding rate in darkness on 5th/6th April, when the moon was approaching the first quarter, gave an average of 5.1 millilitres per hour, i.e. about one third of the daytime rate.

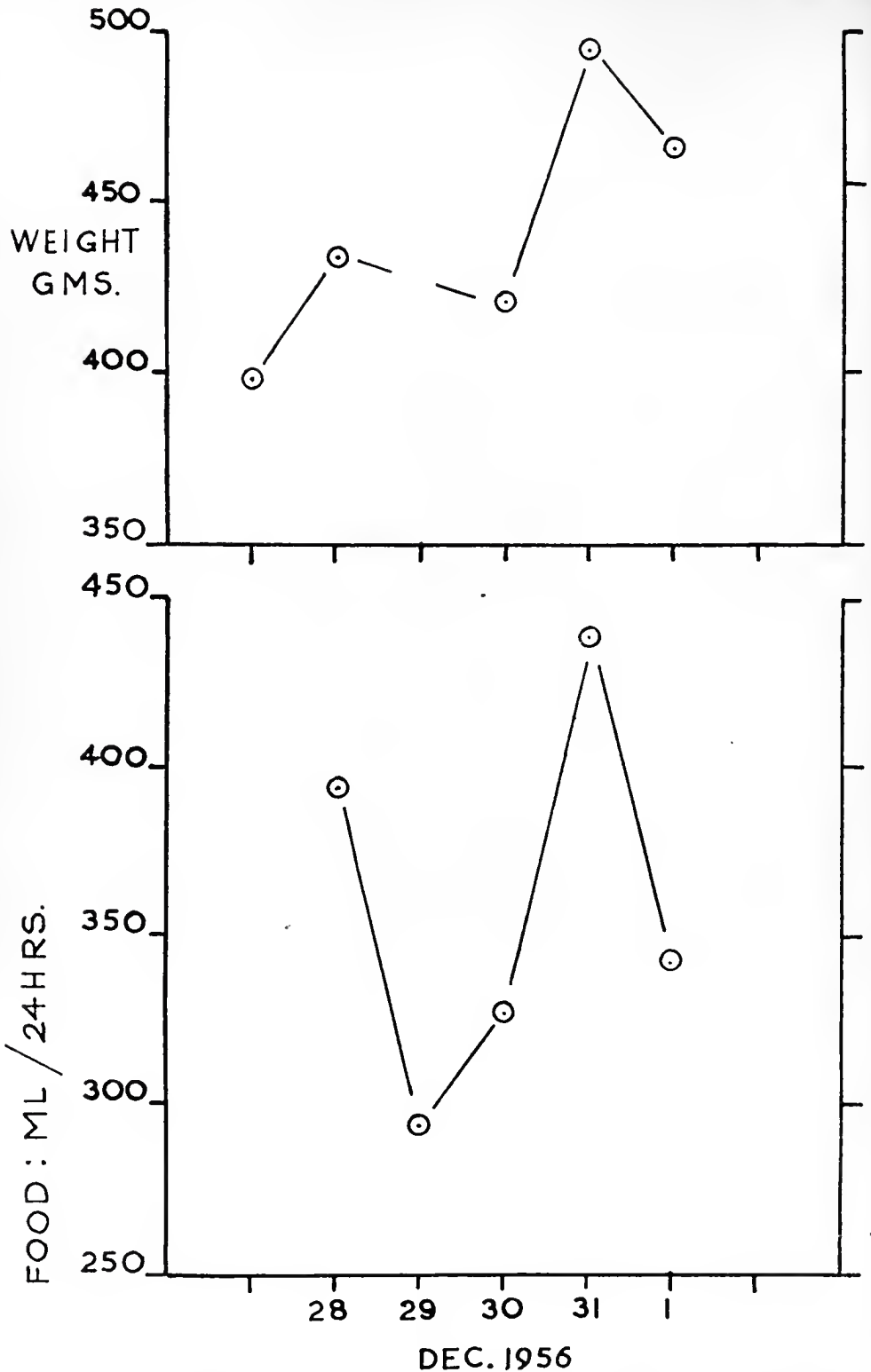

FIG. 2—DAILY FOOD INTAKE, AND CORRESPONDING WEIGHT, OF A CAPTIVE OYSTERCATCHER (*Haematopus ostralegus*): 28TH DECEMBER 1956-1ST JANUARY 1957. The food was mussel meat (*Mytilus*), and the intake is expressed in millilitres ( $\equiv$  cubic centimetres) per 24 hours. This is the bird coded W/B (see Fig. 1), and this figure illustrates the bird's greatly increased food intake, with its return to its former weight, after an experimental period on other foods (see page 143).

The weight of the bird is unknown; it is assumed that, as it had been in captivity in the same conditions for a year, its weight was constant during the observations.

#### *Food and feeding behaviour.*

The limpets offered were collected at random by chipping from rocks and were offered whole to the bird. They ranged in size from 20 to 50 mm. (greatest diameter of shell opening). The samples of shells cleared by the bird showed no selection within this size range.

Dewar (1913) describes the feeding of the Oystercatcher on the limpet. The birds were observed by him to feed on limpets of lengths between 13 and 45 mm. The animals were detached from the rock by a sharp blow laterally, and carried to a crevice in the rock or to sand, where the attachments of the animal to the shell were severed and the meat swallowed. At Seahouses the bird was well accustomed to observation and a close approach was easily accomplished. It took shells either from the heap provided or from the hand and carried them to a patch of soil or grass or a pan of fresh water. Each shell was placed in position by the bill, ventral side uppermost, and the muscle attachments of the animal to the shell were severed by a series of bill thrusts round the edge of the shell. The meat was removed and frequently washed before swallowing.

#### DISCUSSION

Table II shows a summary of food intakes from field and laboratory studies. In all cases the estimates made in the field exceed those made in the laboratory. Colquhoun (1951), discussing the food intake of captive Woodpigeons (*Columba palumbus*), says that "the food requirements can hardly be similar to those of a bird which has been seen (from a following car) to fly at least forty miles to roost at night". No data are available on the effect of activity on the food requirements of such a bird, but the importance of this factor is, of course, well documented in Man. Certainly the difference in activity between captive and wild birds is marked. In the wild, in general, birds spend the major part of the day feeding, after a vigorous activity, and the distances covered in flight are often great. In the cages at Conway and at Seahouses, when an observer was not visible, the birds spent a great deal of time standing still, though they occasionally showed bursts of activity, running up and down their enclosure. The importance of activity is still unmeasured.

The analysis of gut contents allows an assessment of food intake if certain conditions are fulfilled. Colquhoun (1951), for the Woodpigeon, concluded that little insight into food intake can be gained from gut contents as the birds feed irregularly and gut contents are very variable. In most of the field studies on the Oystercatcher the birds showed a steady feeding rate throughout their tidal feeding period and, assuming that food has a

TABLE II—ESTIMATED DAILY FOOD INTAKE OF OYSTERCATCHERS (*Haematopus ostralegus*) IN THE FIELD AND IN THE LABORATORY

The foods studied include mussels (*Mytilus*), cockles (*Cardium*) and limpets (*Patella*). In each study the estimated average volume of meat eaten is expressed in millilitres (= cubic centimetres) per 24 hours.

Area	Food	Meat vol. ml./24 hr.	Source
<i>Field</i>			
Morfa, Conway	<i>Mytilus</i>	389	Drinnan (1958)
Pensarn, Conway			
Oct.-March 1955-56	"	450	"
Morecambe Bay, } Jan. 1954	<i>Cardium</i>	292	Drinnan (1957)
Lancashire } Oct. 1954	"	375	"
Brancaster, March			
Norfolk 1954	"	389	"
Hoylake, March			
Cheshire 1956	"	389-485	Drinnan (unpublished)
	Mean	395	
<i>Laboratory</i>			
Conway W/B } see	<i>Mytilus</i>	275	
B } Table I		237	
Seahouses,			
Northumberland	<i>Patella</i>	257	
	Mean	250	

constant time of passage through the oesophagus and gizzard, an estimate of feeding rate may be obtained.

An estimate of this time can be made from the gut contents of birds examined feeding on cockles (*Cardium*). Oystercatchers coming up to the high water roost in Morecambe Bay (Drinnan, 1957) contained from 47 to 65 (mean 50) millilitres of cockle meats in their oesophagi and gizzards, whereas two hours later they were empty. So we obtain a maximum of two hours for the passage through the oesophagus and crop of 50 millilitres of food.

In Table III are shown the estimated food intakes in millilitres

TABLE III—ESTIMATED HOURLY FOOD INTAKE OF OYSTERCATCHERS (*Haematopus ostralegus*) IN THE FIELD

These estimates are from birds showing a steady feeding rate through the tidal feeding period. The intake is expressed in millilitres (= cubic centimetres) per hour.

Area	Food intake ml./hr.	Comments
Brancaster, Norfolk	58.8	2 × 2 hr. feeding periods per tide.
Morecambe Bay, Lancs.	)	
Jan. 1954	20.9	)
Oct. 1954	25.9	)
Conway, Caerns.	)	Average of whole of tidal feeding period.
Morfa	28.7	)
Pensarn	25.9	)
Hoylake, Cheshire	25-26	)



per hour from Oystercatchers showing a steady feeding rate through the tidal feeding period. They range from 20-28 ml./hr. with a mean of 25.5 ml./hr. On the basis of a two-hour period to empty the oesophagus and gizzard, we should expect to find the result of two hours feeding in the gut contents of birds. In October 1954 when the birds whose gut contents are described above were shot, the average feeding rate was 26 ml./hr. The average content of oesophagus and gizzard was 50 ml.

The greatest volume of food found in the oesophagus and gizzard of an Oystercatcher in October 1954 was 65 ml. In this bird the oesophagus and gizzard seemed to be completely full, though Colquhoun (1951) mentions a pigeon, with a highly developed crop for storage, containing 280 ml. of food. If we assume 65 ml. to represent a full oesophagus and gizzard in an Oystercatcher, then the observed alternation of feeding and rest periods (Drinnan, 1957, 1958), with a consistent average food intake of approximately half the volume of crop and gizzard per hour, suggest that the birds were eating to capacity.

In December 1956 eight birds were netted in Morecambe Bay, on a night with no moon, three hours after darkness, at a time when cockles were still uncovered and feeding was possible. The contents of their oesophagi and gizzards were 19, 18, 21, 22, 21.5, 31.5, 24.5, 22 ml. respectively, with a mean of 22.4 ml. If we assume that the birds had been feeding immediately before being caught, then, if the contents of oesophagus and gizzard represent two hours feeding, the birds had been feeding in the dark at a rate of 11.2 ml./hr., approximately half the rate normal in daylight. This would agree with the value obtained from laboratory feeding on mussels at night. The birds may not have been feeding for an hour before their capture, but the presence of cockles in the oesophagus of the birds caught tends to discount this possibility.

It was estimated (Drinnan, 1957) that the birds in Morecambe Bay ate 18% of their own live weight per day (dry weight of food). This was based on a specific gravity of 1.00 for the flesh of the food. Later estimations have shown 1.07 to be a truer figure.

In Table II the average estimated food intake per 24 hours is 395 ml. This gives  $395 \times 1.07 = 423$  gm. of wet meat (or 106 gm. dry weight). The average live weight of eleven Oystercatchers with empty guts in December 1956 was 460 gm. So we obtain a figure of 23% of live weight eaten per day. Since the night feeding rate is about half that in daylight, this necessitates a drop in the estimated dry food intake per day from 25% to 17.5% of the bird's live body weight.

Comparable observations on wild birds are few. Any comparison of feeding rates must be made with caution when such variables as calorific value of food and digestive efficiency are unknown. Lack (1954) reviews the literature and cites the following. Pynnönen (1939) found the Great Spotted Woodpecker

(*Dendrocopos major*) to take 8-10% of its own weight daily in conifer seeds. The Red-tailed Hawk (*Buteo jamaicensis*) (Fitch *et al.*, 1946) ate 12% of its body weight per day in snakes and mammals; the same species in captivity eating 18% of its body weight per day. Southern (1954) found the incubating Tawny Owl (*Strix aluco*) to take 18% of its body weight per day in rodents. Gibb (1956) made observations in the field on the feeding of the Rock Pipit (*Anthus spinoletta*) and found the bird to be eating 18-25% of its own live weight daily (organic dry weight of food).

Lack summarizes the extensive literature on food intake in captivity thus: "land-birds weighing between 100 and 1,000 grammes tend to eat about 5 to 9 per cent. of their body weight of food each day, whereas song-birds weighing 10 to 90 grammes tend to eat 10 to 30 per cent. of their own weight each day, but these figures are very approximate, as there is much variation, with the conditions and with the type of food".

Certainly the observed feeding rates of large birds in the field, with the exception of those of Pynnönen, exceed Lack's 5 to 9 per cent. Gibb (1956) comments on Pynnönen's observation: "It is (also) difficult to understand how Pynnönen's (1939) woodpecker, weighing 4-5 times as much as the other species, apparently existed in December in Finland with fewer calories than the pipit or sparrow; and took less than twice as much pine seed as the captive Great Tit (*Parus major*) in Britain".

#### SUMMARY

1. The food intake and feeding behaviour of captive Oystercatchers is described. The birds ate 230-260 millilitres (= cubic centimetres) of food (mollusc flesh) per day, while maintaining constant weight. After a loss of weight the food intake rose to an average value of 359 ml. per day.

2. Comparison of the feeding rates in dark and light showed a constant difference, the rate in the dark being approximately half that in the light.

3. Estimates of food intake in the field (mean 395 ml. per 24 hours) give a consistently higher figure than those obtained in the laboratory. This difference is discussed with special reference to the differing activities of the two groups of birds.

4. An analysis of the gut contents of birds shot in the field, supports, with some assumptions, the field estimates of food intake during the daylight. The gut contents of birds feeding in the dark suggest a feeding rate half that in daylight. It is suggested that the Oystercatchers observed in the field were feeding to capacity.

5. If the night feeding rate is assumed to be half that of the day, the birds in the field are estimated to be eating an amount of dry food equal to 17.5% of their own live body weight per day.

#### ACKNOWLEDGEMENTS

The author is grateful to Dr. E. A. R. Ennion for hospitality



K. Kottan

SCOPS OWL (*Otus scops*) AT NEST-HOLE; FAHU, HUNGARY, JUNE 1953

This very small starling-sized owl of the S. Palaenctic is predominantly greyish-brown, delicately marked with blackish streaks, wavy barring and fine vermiculations (see page 150). Its tarsi are feathered (as is typical of owls), but the grey toes are quite bare.



K. Kottan

SCOPS OWL (*Otus scops*) AND YOUNG; FAHU, HUNGARY, JUNE 1953

The under-parts are paler, with the vermiculations not so close, but the shaft-streaks more pronounced. One particularly associates this species with the proximity of houses, and this nest was in an artificially-erected hollow stump in an orchard walnut-tree (see page 151).



K. Koffan

SCOPS OWL (*Otus scops*) ALIGHTING AT NEST: TAHU, HUNGARY, JUNE 1953

The tail and flight-feathers are barred with whitish, buff and grey. Note that in none of these photographs are the "ear-tufts" visible, and this is often the case, but it is a slimmer bird than the Little Owl (*Nyctale noctua*), with a much smaller head, and the upright shape of its facial discs give it a questioning look that is markedly different from the other's frown. Scops Owls are, however, heard more often than seen and their monotonous whistle is their best-known feature (see page 149).

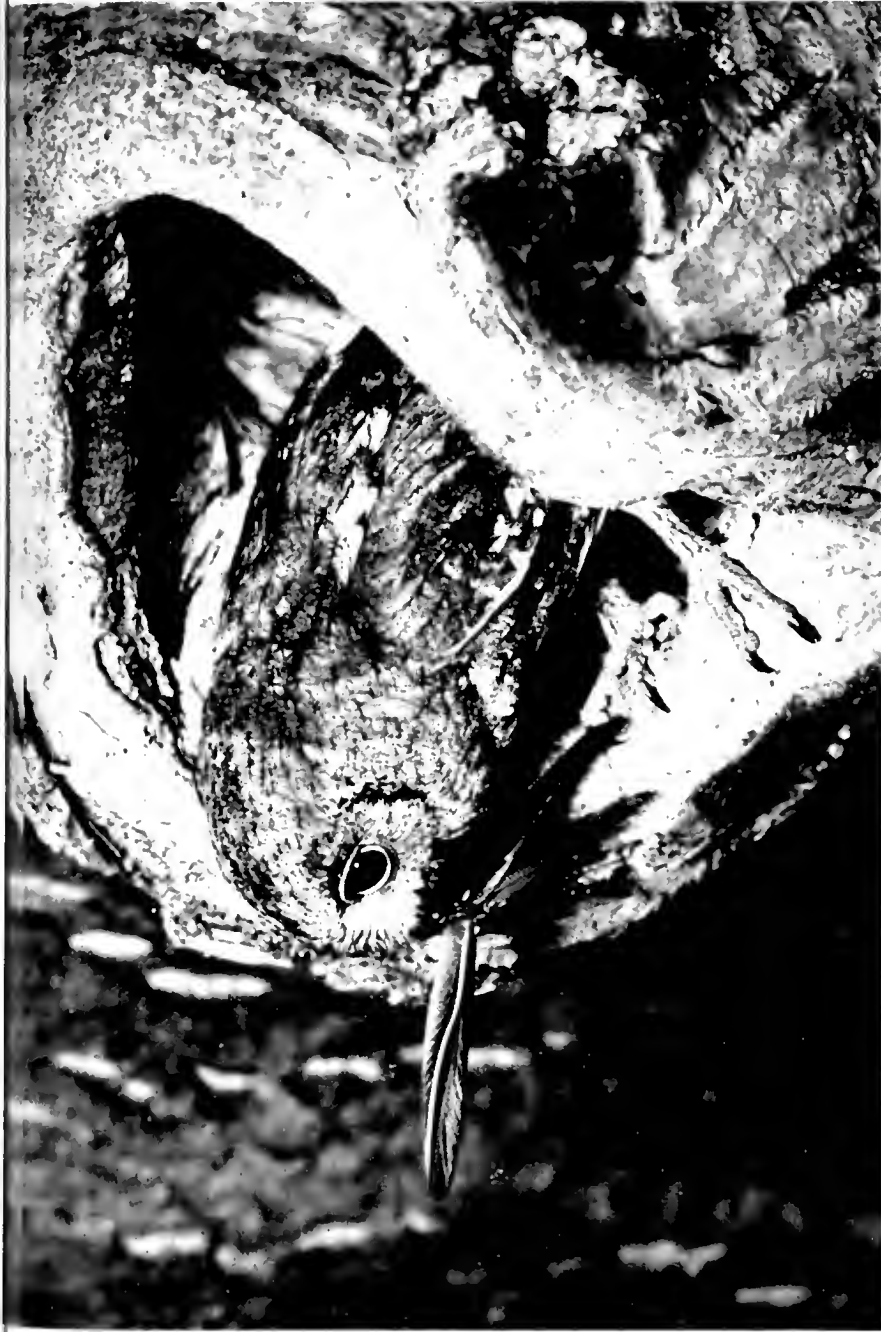

K. Koffin

SCOPS OWL (*Otus scops*) AT ENTRANCE TO NEST: TAIT, HUNGARY, JUNE 1953

Here one gets a particularly good impression of the intricate pattern of the upper-parts, including the line of creamy marks on the scapulars (see also plate 25 upper). Largely insectivorous, this species feeds mostly on beetles, grasshoppers and moths, but small birds, rodents and lizards are occasionally taken. Scops Owls are mainly nocturnal and most of the feeding at this nest took place between sunset and total darkness; one of the adults stayed at the nest during the daytime (see page 150).



SCOPS OWLS (*Otus scops*): TAHU, HUNGARY, JUNE 1953

K. Koffán

On the left is an unusual flight-study as the bird brakes with tail and wings and brings its feet forward to clasp the nest-hole. The other photograph illustrates the size by comparison with a human hand, but the normal alert posture is more upright and attenuated (see page 150). The shaft-streaks are particularly wide at the sides of the breast. The irides are yellow; and note the small size of the pupils by day, compared with the rest of this series.

and co-operation in the observations on the Oystercatcher at Sealhouses.

## REFERENCES

- COLQUHOUN, M. K. (1951): "The Wood Pigeon in Britain". *Agric. Res. Council Rep. Ser. 10*, 1-69.
- DEWAR, J. M. (1913): "Further observations on the feeding habits of the Oyster-catcher (*Haematopus ostralegus*)". *Zoologist*, 17: 41-56.
- DRINNAN, R. E. (1956): "An investigation of Oystercatcher feeding in Morecambe Bay". *Merseyside Naturalists' Assoc. Bird Report*, 1954-55: 30-32.
- (1957): "The winter feeding of the Oystercatcher (*Haematopus ostralegus*) on the cockle (*Cardium edule*)". *J. Anim. Ecol.*, 26: 439-467.
- (1958): "The winter feeding of the Oystercatcher (*Haematopus ostralegus*) on the edible mussel (*Mytilus edulis*) in the Conway Estuary". *Fish. Invest. Ser. II*. (in press).
- FITCH, H. S., SWENSEN, F., and TILLOTSON, D. R. (1946): "Behaviour and food habits of the Red-tailed Hawk". *Condor*, 48: 205-237.
- GIBB, J. (1956): "Food, feeding habits and territory of the Rock Pipit *Anthus spinoletta*". *Ibis*, 98: 506-530.
- LACK, D. (1954): *The Natural Regulation of Animal Numbers*. Oxford.
- PYNNÖNEN, A. (1939): "Beiträge zur kenntnis der Biologie finnischer spechte". *Ann. Soc. Zool.-Bot.-Fenn. Vanamo*, 7 (2): 1-166.
- SOUTHERN, H. N. (1954): "Tawny Owls and their prey". *Ibis*, 96: 384-410.

## PHOTOGRAPHIC STUDIES OF SOME LESS FAMILIAR BIRDS

### LXXXVII. SCOPS OWL

Photographed by K. KOFFAN

(Plates 25-28)

Text by I. J. FERGUSON-LEES

ONE OF THE characteristic spring and summer sounds of parts of southern Europe is the musical, yet monotonous, low single whistle which forms the song of the Scops Owl (*Otus scops*). On a warm evening in the south of France one can often hear, at one time, several of these delightful little birds uttering their whistling *kyeu* over and over again, at intervals of about 2-4 seconds, for tens of minutes or even hours on end. It is a melancholy sound of which one can quickly tire, but it is an essential part of the hot southern nights and one welcomes it at first, just as one does the spring call of the Cuckoo (*Cuculus canorus*). Probably one of the easiest of animal noises to imitate, it can give one endless entertainment, for no bird plays up better and one can join in a continuous duet. This is primarily a nocturnal species—far less likely than the larger Little Owl (*Athene noctua*) to be seen or heard by day—and the sound is one of dusk and night-time.

The Scops Owl has already appeared once in our series, some years ago (*antea*, vol. xlv, plate 81, p. 401), but as on that occasion we had only a single photograph for publication—an excellent study of Walter E. Higham's, taken in the Camargue—

we feel more than justified in using the fine, varied series that Mr. Koffán has kindly sent us from Hungary. Plate 28 right, showing one of these owls perched on a human hand, gives a good indication of the very small size of this species which comes about half way between the familiar Little Owl and the tiny Pygmy Owl (*Glaucidium passerinum*) which we recently illustrated (*antea*, plates 13-16). In the field, indeed, it appears much smaller than the Little Owl, for not only is it an inch shorter, but it is altogether a slimmer bird with, as can be seen in these photographs, a rather smaller head. An important point, which is often not emphasized enough, is the fact that its flight has the silent wavering action of the typical owls, and lacks the characteristic "bounding" undulations of the Little Owl.

If one is lucky enough to get a close view of a Scops Owl, one can see that its face, too, has quite a different cast about it (as P. A. D. Hollom commented in writing about Mr. Higham's photograph), due to the different shape of the facial discs: in the Scops these discs are a little longer than they are broad, giving the bird a questioning look in contrast to the flat-browed, frowning effect produced by the Little Owl's facial discs which are distinctly broader than long. This is particularly brought out in plates 25 upper and 26, as is the fact that the "ear-tufts" which this species possesses, and which are so often given prominence in illustrations, do not show at all when the bird is at ease (in this connection note particularly the side view on plate 27). However, when aware of being seen, a Scops Owl draws itself up with body attenuated and ear-tufts fully erected, rather like a very small Long-eared Owl (*Asio otus*), and if the observer does not move too quickly may remain in that posture for several minutes. Like Long-eared Owls, Scops roost by day close up against the trunks of trees, or the stems of bushes, and are very hard to see.

The upper-parts (plates 25 upper and 27) are greyish-brown, more reddish-brown at the sides of the mantle and at the edges of the facial discs, the whole beautifully and delicately patterned by blackish-brown shaft-streaks and wavy barring and by fine vermiculations. The reddish feathers surrounding the lower part of the discs are tipped with black and form a distinct "ruff". Along the scapulars there is a conspicuous line of creamy-white oval patches (plates 25 and 27). The under-parts are paler, with the shaft-streaks more pronounced (plates 25 lower, 26 and 28 right) and the vermiculations sparser on the belly and flanks. The tail and flight-feathers are barred to varying degrees with whitish, buff and grey (plate 26). The tarsi are covered with buff feathering streaked with dark brown, but (unlike some other members of this genus) the grey toes are quite bare. The irides are lemon-yellow and it is interesting to compare the size of the pupils in the day-time photograph (plate 28 right) with the dilated circles of the birds at dusk in the rest of these plates.

The species is a partial migrant, wintering in tropical Africa and



breeding in N.W. Africa, southern Europe, Turkey, Syria, Jordan and N. Iraq, and in the western half of the U.S.S.R. from central Russia and the Caspian Sea area across to Altai and nearly to Lake Baikal, extending down into N. Mongolia. It is thus absent from eastern, south-eastern and southern Asia, where it is replaced by three other related species of small "eared" owls (*O. bokkamocna*, *brucei* and *sunia*); further members of the genus breed in America (notably the Screech Owl, *O. asio*) and Africa. The Scops Owl is a curiously patchy bird in its distribution: it is, for example, very much scarcer in southern Spain than it is in southern France. To Britain it is a rare vagrant, chiefly in the spring and early summer and mainly in southern and eastern England (though it has occurred no less than six times as far north as Shetland).

One particularly associates this owl with the proximity of human habitation and, though it is frequently found in open woodland and parkland well away from houses, it is as a bird of gardens and roadside trees that it will usually be remembered—but more often as a voice than as a shape! In southern Europe the breeding-season of the Scops Owl lasts for some seven weeks from the very end of April to the middle of June, and Mr. Koffán's photographs were obtained on 10th and 11th June 1953, in an orchard in a garden at Tahy, about 20 miles from Budapest. This species, like many other owls, breeds chiefly in holes in trees, sometimes in old buildings and occasionally in the nests of other birds, especially crows (Corvidae). Like the other small owls, however, it will also use nest-boxes and the site in this case was an artificially-erected hollow stump placed about 10 metres (ca. 33 feet) above the ground, in a walnut-tree. For the purpose of the photography the box was gradually lowered, during the preceding days, until it was only about 3 feet above the ground (and it was afterwards replaced). A single flash-lamp was used and a small green light was hung on a branch about a yard from the box; the latter was sufficient to illuminate the scene without frightening the birds.

Usually between three and six white eggs are laid, and authorities differ as to whether incubation starts with the first or on completion of the clutch: the period is about  $3\frac{1}{2}$  weeks. *The Handbook* states that during the fledging-period all food is "brought by male, distributed by female", but it seems likely that this applies only when the young are small, as is the case with a number of other owls and with many of the diurnal birds of prey. Mr. Koffán found, for example, at the nest shown in these photographs, where the three young were quite large (see plate 25 lower), that one of the adults, presumably the female, remained in the hole all the day and on the evening he was watching left at 19.43 hours, after which, for a period of an hour, the parents arrived with food at intervals of approximately five minutes. Then there was an interval between 20.50 and 21.20, and

“afterwards they fed the young very seldom at night, if they did feed them then at all, and they only started again at dusk”. The young are said to leave the nest on the 21st day before they are fully fledged, but once they are in full juvenile plumage they look much more like the adults than do most young owls: the feathers are more compact and chiefly not down-like, though the markings are paler and less distinct.

Plate 27 shows one of the adults carrying a grasshopper, and a moth is just visible in the beak of the flying bird on plate 28 left: these insects, and beetles, form the main food of the Scops Owl, but also occasionally taken are mice, lizards and small birds. Goldfinch (*Carduelis carduelis*), Coal Tit (*Parus ater*), Ortolan Bunting (*Emberiza hortulana*) and Yellowhammer (*E. citrinella*) are among the bird-species recorded.

## WADERS AT OCEAN WEATHER SHIPS IN 1956

By IVOR McLEAN and KENNETH WILLIAMSON

DURING 1956 the first-named author was at sea for long periods as a member of the scientific staff of the Marine Section of the Meteorological Office (Air Ministry). Many observations were made on the occurrence of migratory birds in the vicinity of the stations occupied by the Weather Ships, and a full record of these has been lodged with the Editor of the *Marine Observer*. There were two outstanding periods of Passerine movement, one at station “India” in late September, the other at station “Juliett” in early November, and a short paper discussing these in relation to weather and the migrational drift theory has already appeared (McLean and Williamson, 1957). There remain a few isolated records, chiefly of waders, which we feel have unusual ornithological interest, and these are brought together in the present contribution. (For a note on Merlins (*Falco columbarius*) observed at sea, see pp. 157-158.)

The stations concerned are as follows: “Alpha”, latitude 62°00’N., longitude 33°00’W.; “India”, latitude 59°00’N., longitude 19°00’W.; and “Juliett”, latitude 52°30’N., longitude 20°W. Nicholson (1951) has divided the North Atlantic into regions; “Alpha” lies close to the southern edge of Greenland Approaches, whilst “India” and “Juliett” are at the north-western and south-western limits respectively of Rockall Seas.

Our thanks are due to the Editor of the *Marine Observer* for permission to repeat some of the information contained in the above-mentioned paper; to Mr. R. G. Findlay for supplying certain observations; and to the Controller of H.M. Stationery Office for permission to reproduce weather-charts from the *Daily Weather Report* of the Meteorological Office (Air Ministry).

OYSTERCATCHER (*Haematopus ostralegus*).—A party of four

passed in the early afternoon of 15th April at  $61^{\circ}52'N.$ ,  $18^{\circ}28'W.$ , probably returning to Iceland. See also under the next species.

**GOLDEN PLOVER** (*Charadrius apricarius*).—Two birds showing characteristics of the Northern form (*Ch. a. altifrons*) passed "Alpha", flying north-east into a 28-knot wind, on the evening of 4th May. The previous day there had been a single Oystercatcher and Dunlin (*Calidris alpina*), following a north-east gale with low cloud and rain overnight. R. G. Findlay reported that a Whimbrel (*Numenius phaeopus*) came aboard at "India" the same day (3rd May). It is possible that all these birds, travelling from the south, missed Iceland in the thick weather of successive occlusions which overtook them from the west (Figs. 1 and 2).

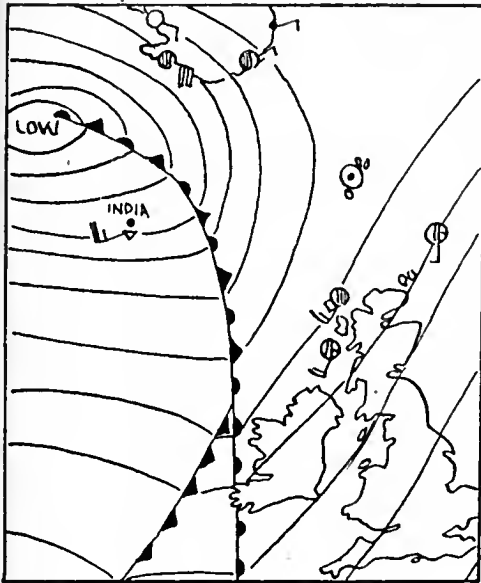

Fig. 1

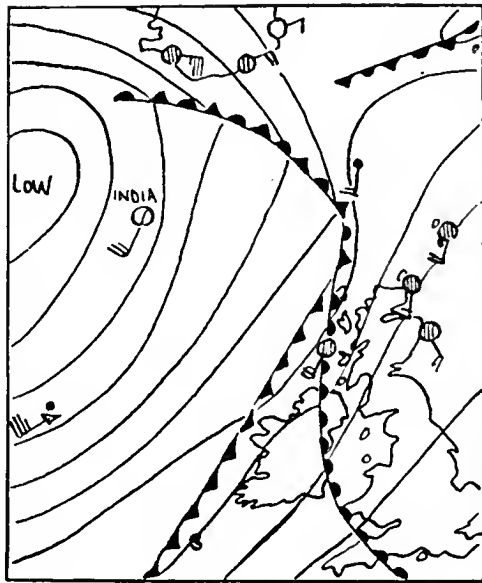

Fig. 2

FIGS. 1 and 2—SYNOPTIC SITUATION IN NORTH-EAST ATLANTIC AT 1000 HOURS ON 3rd MAY 1956 AND 1800 HOURS ON 4th MAY 1956, SHOWING OCCLUDED FRONTS MOVING ACROSS BRITAIN-ICELAND MIGRATION ROUTE

**TURNSTONE** (*Arenaria interpres*).—A Turnstone at "India" on 20th September stayed for seven hours from 07.30 hours and flew off down-wind on leaving: there was a complex low to the west and the wind was south-east at 20 knots; this may have brought it from the misty cool weather along the inter-islands route farther east (Fig. 3). Three others circled the vessel in mid-morning, and there was one on the 24th.

**CURLEW** (*Numenius arquata*).—At "Juliett" on the afternoon of 15th August three Curlews appeared from the north, flying fairly high and calling frequently. After circling high overhead for a quarter-of-an-hour they made off south-eastwards. There had been an adult Ringed Plover (*Charadrius hiaticula*) about the ship just after mid-day and it is possible these birds had been caught

in off-shore winds ahead of a warm front crossing Northern Ireland. Visibility had been very poor with low cloud and drizzle, but a passing cold front at 16.00 hours had improved it to about five miles.

**PURPLE SANDPIPER** (*Calidris maritima*).—One came aboard at "Juliett" at 10.00 hours on 2nd November, two others at 14.00 hours, a fourth at 16.40 hours, and a fifth some time after dark. They were still present on the 3rd, when another arrived, but one was drowned in mid-morning when it settled on the sea and was unable to rise again. One died late on the 3rd, and there were still four aboard at daybreak on the 4th, but only one could be found at 10.00 hours and this was still there at dusk. It is probable that all succumbed, for they appeared to be absolutely exhausted and once aboard were very reluctant to fly, preferring to run along the deck if disturbed. A bird caught late on the 2nd weighed only  $1\frac{3}{4}$  oz. (ca. 50 gm.) and of three caught later one weighed 2 oz. (ca. 57 gm.) and the others  $1\frac{1}{2}$  oz. each (ca. 42 gm.). Weigold (1926) gives an average of 72 gm. for three migrants at Heligoland, and quotes Hantzseh for Icelandic birds, presumably breeders, as follows—4 ♂♂, 74-80 gm., 5 ♀♀, 80-95 gm. Thus the loss sustained by the birds at "Juliett" during their migration seems likely to have been of the order of 40%. North of the ship's position at this time was a high pressure centre influencing the whole north-east Atlantic, and considering the vastness of the anticyclone and their extremely weak condition an origin as far distant as east Greenland does not seem unreasonable. It may be mentioned that on 3rd November at least six Snow Buntings (*Plectrophenax nivalis*), also in poor shape, joined the ship: two were subsequently drowned in the same way as the sandpiper, and one had the incredibly low weight of half-an-ounce (ca. 15 gm.), which must represent a 60% drop from "normal" body-weight. Another was rather better at one ounce (ca. 28 gm.).

**BUFF-BREASTED SANDPIPER** (*Tryngites subruficollis*). — This North American vagrant was first seen at 10.00 hours on 21st September at "India" and was slain by the ship's cat in the afternoon. It was a rather long-legged wader and seemed plump as it stood with head "hunched" on shoulders, and the carriage and pose were very plover-like. The following description was made from the body, which was not preserved:

*Upper-parts*: Crown feathers dark brown edged buff; nape buff spotted dark brown; mantle and back blackish-brown edged white; upper tail-coverts dark brown edged buff; ear-coverts, cheeks and sides of neck buff. *Wings*. Primaries blackish-brown narrowly edged white, inner webs white with dark brown speckling; secondaries similar; greater coverts dark brown speckled black and tipped buff; median coverts grey brown edged buff and tipped white, with "Y"-shaped dark markings; lesser coverts blackish-brown edged buff; primary coverts dark brown tipped white. *Under-parts*: Chin, throat, breast and upper belly buff shading to white tinged with buff on lower belly and under tail-coverts; chin paler than throat; sides of breast with dark brown spots; axillaries and under wing-coverts

white, the underside of the wing-coverts banded and speckled with black; coverts along the leading-edge buff spotted dark brown. *Tail*: Blackish-brown, narrowly edged white; outer feathers banded and speckled dark brown and tipped white. *Bill*: Dark brown, fairly short and plover-like. *Legs*: Greenish-yellow.

The measurements were: wing 138 mm., tail 56.5 mm., tarsus 31.5 mm., bill (from feathers) 20 mm. The wing-formula gave first primary minute and second longest, with the third to the sixth shorter by 2.5, 9.5, 19 and 28 mm. respectively. The body was not sexed, but there is a size difference between the sexes and the wing-length is at the upper limit of the range given for males by Witherby *et al.* (1940). The mantle and other plumage characters suggest a first-year bird.

A vast low-pressure system covered the North Atlantic at this time, one centre of which had swept down from Labrador (with fronts crossing the Gulf of St. Lawrence) during the 18th-19th and had moved to the south of Cape Farewell by the 20th, so that there was a generally westerly airstream across the ocean to the vicinity of station "India" (Fig. 3).

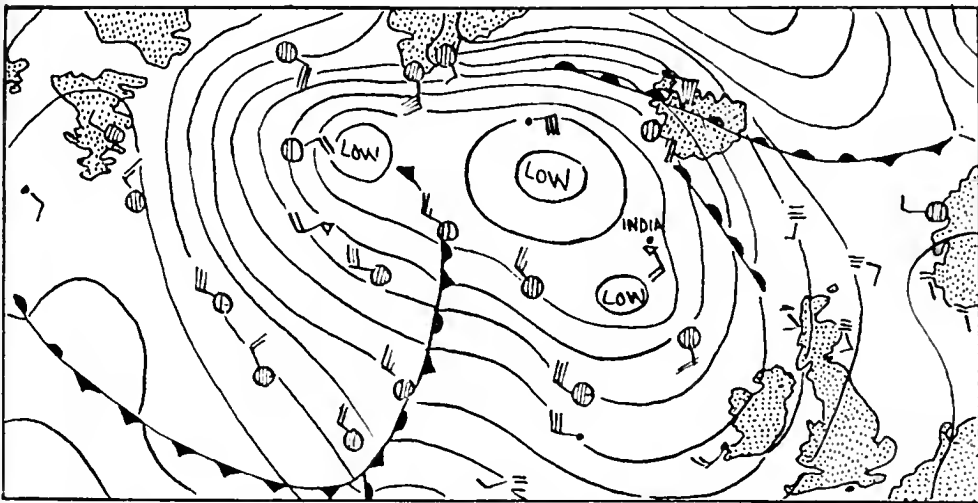

FIG. 3.—SYNOPTIC SITUATION IN NORTH ATLANTIC AT MID-DAY ON 20th SEPTEMBER 1956, BEFORE THE ARRIVAL, ON THE 21st, OF A BUFF-BREASTED SANDPIPER (*Tryngites subruficollis*) AT STATION "INDIA" (59°N., 19°W.)

RUFF (*Philomachus pugnax*).—At "Juliett" at 1610 hours on 7th August a wader was seen in the ship's wake about fifty yards astern. It flew round for about ten minutes, coming very close at times, and was identified as a juvenile Ruff. On one occasion it settled on the sea for a few seconds, and twice hovered with dangling legs as though about to repeat the performance. It appeared from the north-east, and finally flew away to the south. The ship was in a warm sector on the north-east edge of the Azores anticyclone and the weather was overcast with a fine drizzle and poor visibility, cloud-base at 400 feet and wind south-west at 19 knots.

GREY PHALAROPE (*Phalaropus fulicarius*).—A first-winter bird came aboard at "Juliett", late on 8th November. Viewed from above, the bill was flattened and widened slightly towards the tip: it had two grooves along each side and was black with a yellowish base. The short legs were dark horn and there were flesh-pink patches on the lobes. Measurements were: wing 126 mm., tail 61 mm., tarsus 20 mm., bill (from feathers) 21 mm.

When released the bird showed no inclination to fly, and it spent the night in the balloon shed. It was seen to fly away at 05.30 hours next day. An intense depression situated near Iceland covered the eastern Atlantic, and there can be little doubt that the bird was a cyclonic migrant from the Greenland area in the strong north-west winds of this low.

#### SUMMARY

1. Observations are given of migrant waders appearing at Weather Ships stationed at "Alpha" in Greenland Approaches, and at "India" and "Juliett" at the north-west and south-west extremities respectively of Roekall Seas.

2. Several records concern birds apparently displaced from the inter-islands route, connecting Britain and Iceland, by south-easterly winds associated with bad visibility in this region (Oystercatchers, Golden Plover, Turnstone).

3. Two clear cases of cyclonic overseas migration are provided by a Buff-breasted Sandpiper at "India" on 20th September 1956 (from eastern North America), and a Grey Phalarope at "Juliett" on 8th November (from Greenland).

4. Exhausted Purple Sandpipers at "Juliett" in anticyclonic weather on 2nd and 3rd November seem likely to have travelled from east Greenland round the eastern periphery of the high, losing approximately 40% of their body-weight during the journey.

#### REFERENCES

- MCLEAN, I., and WILLIAMSON, K. (1957): "Migrants at North Atlantic Weather Ships in 1956". *Marine Obs.*, 27: 152-156.  
 NICHOLSON, E. M. (1951): "Birds of the North Atlantic". *Proc. Xth Int. Orn. Cong.*, 600-602.  
 WEIGOLD, H. (1926): "Masse, Gewichte und Zug nach Alter und Geschlecht bei Helgolander Zugvögeln". *Biol. Anstalt auf Helgoland*, no. 17.  
 WITHERBY, H. F. *et al.* (1940): *The Handbook of British Birds*. Vol. IV. London.

#### NOTES

**Fish-hook in Heron's pellet.**—In March 1956 Tom Schutte brought me the pellet of a Heron (*Ardea cinerea*) that he had found on the 4th of that month, by the River Beane at Waterford, Hertfordshire. It was composed almost entirely of fur (? Water Vole, *Arvicola amphibius*), but embedded in it was a complete fishing-hook, three-quarters of an inch long, and some 11½ inches of gut.

ERIC HOSKING

[We showed this record to Mr. Frank A. Lowe, author of *The*

*Heron* (1954), and to Mr. D. F. Owen, who has made a special study of the food of Herons. Mr. Lowe commented: "I have no record of a fish-hook having been found in a bird's pellet, but I understand that metal objects are sometimes found—such as pigeon rings in the pellets of Peregrines (*Falco peregrinus*). A Heron's digestive juices are capable of dealing with every part of a fish, and most of a mammal except for its hair and sometimes tooth enamel. One would not expect these digestive juices to remove steel, and apparently the attached length of gut was unaffected. The fact of the barb's being embedded in the fish would carry it safely to the stomach where it would be encased in the mammal hair and disposed of without much danger. Herons will on occasion even 'eat' part of their nests to get pellet material, so necessary to rid themselves of indigestible matter".

Mr. Owen wrote: "I have a similar record, of a fish-hook in a meal regurgitated by a nestling Heron at Wytham, Berkshire, on 16th May 1952. The fish hook seemed to come from a crayfish (*Astacus*) in this instance; crayfish are a minor curse to some waters in that they take lines and often snap away with the hook. I have examined very large numbers of Heron pellets, besides the work I have been doing for five years on the food of nestlings, and this is the only record I have".—EDS.]

**Merlins at sea.**—Chance observations of Merlins (*Falco columbarius*) at sea are not rare, but the following record of a bird remaining "off-passage" at a weather-ship is probably unique. The observation was made on board *Weather Observer* at station "India" (59°N., 19°W.), some 300 miles south of Iceland and 500 miles west of Cape Wrath. The bird, a female, came aboard at 16.40 hours G.M.T. on 23rd September 1956 with col weather to the northward, remained with the ship a week, and was last seen flying in a south-easterly direction at 08.00 hours on 1st October, with a moderate northerly wind and the chance of a cyclonic passage to Britain round the edge of a low centred to the east of the Faeroe Islands (Fig. 1). Thus its arrival and departure took place under similar conditions to those shown to govern the arrival of Icelandic Merlins (*F. c. subaeson*) at Fair Isle (*antea*, vol. xlvii, pp. 434-441). During its stay some scraps of raw meat were put out for it, and it ate them; although it gave chase to small migrants, and on one occasion a Storm Petrel (*Hydrobates pelagicus*), it was seen to kill only one Whetear (*Oenanthe oenanthe*), on the 30th. Merlins occasionally remain "off-passage" at Fair Isle for some time (there were records of 19 and 14 days for two ringed birds in autumn 1956), but that one should do so for a full week at a weather-ship in mid-ocean is very remarkable.

A second female Merlin appeared on 28th September but did not stay long: the "inter-islands route" away to eastward, linking Iceland and Scotland, had col weather marred by fog, and lost

migrants such as Wheatears, Meadow Pipits (*Anthus pratensis*) and White Wagtails (*Motacilla a. alba*) also came to the ship on the south-east wind.

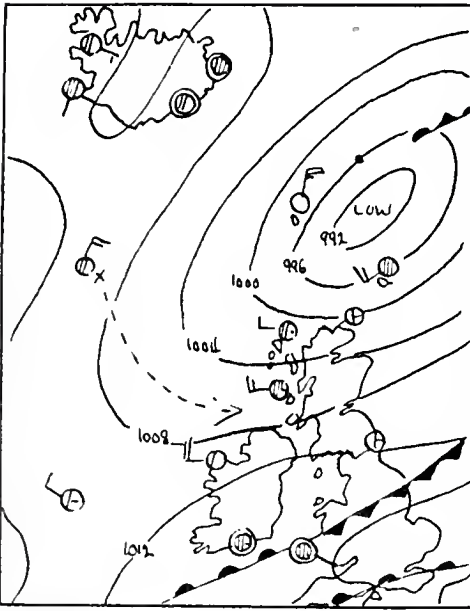

Fig. 1

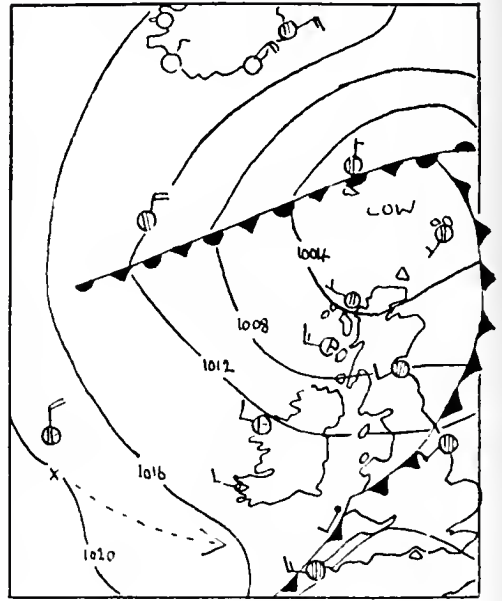

Fig. 2

FIGS. 1 and 2—SYNOPTIC SITUATION IN NORTH-EAST ATLANTIC AT 0600 HOURS ON 1ST OCTOBER 1956 AND 1800 HOURS ON 2ND OCTOBER 1955, SHOWING PROBABLE CYCLONIC APPROACH OF MERLINS (*Falco columbarius*) TO BRITISH ISLES FROM THE POSITIONS ("X") WHERE THEY WERE SEEN AT SEA

We have looked at the weather-charts appropriate to Dr. D. H. Wilkinson's bird (*antea*, vol. xlix, p. 501) and think there is little doubt that this was a cyclonic migrant from Iceland, rounding a depression which had its centre over the Faeroe Islands (Fig. 2). Perhaps the most unexpected occurrence of *subaesalon* at sea, however, is the male with a wing of 213 mm., now in the British Museum (Natural History), which was taken on board a fishing vessel 26 miles east of Spurn Point, Yorkshire, on 12th October 1910. IVOR McLEAN and KENNETH WILLIAMSON

**Variant leg and bill colour of the Moorhen.**—A number of previous notes on the subject of Moorhens (*Gallinula chloropus*) with yellow legs or bills have been published (*antea*, vols. xliii, p. 383; xliiv, p. 140; xlv, p. 39; and xlvi, p. 189). These records related respectively to an otherwise normal immature bird, two albino adults, and a normal adult. In the cases of the albinos, both the legs *and* the bill were entirely yellow, but in the normally-plumaged immature and adult birds only the legs were yellow. Dr. Stuart Smith (*ibid.*, vol. xliiv, p. 140), when recording one of the albino adults, suggested that the replacement of the normal bill and leg colour by yellow was probably associated with



albinistic tendencies. While undoubtedly applicable in many cases, this cannot be accepted as an invariable rule, for I have records of albinistic Moorhens with normally coloured soft parts and normal-plumaged individuals with yellow soft parts. Furthermore, an albino Moorhen seen at Woodhall Park, Hertfordshire, on 1st September 1956, had the legs, feet and bill entirely bright yellow, but six months later, when the bird was seen again on 16th March 1957, the bill had assumed the normal colour pattern, though the legs and feet were still yellow. It is obvious, therefore, that this abnormal colouration of the soft parts is not necessarily correlated with the colour of the plumage, which may equally well be normal or albinistic. It seems likely that this condition occurs quite frequently in other species. I have already recorded (*Bull. Brit. Orn. Cl.*, vol. 76. pp. 32-33) a Wren (*Troglodytes troglodytes*) seen in the Panshanger Estate, Hertfordshire, on 17th September 1955, which had bright yellow legs and feet but was otherwise normal. There are also the numerous cases of Herring Gulls (*Larus argentatus*) with yellow legs that have been seen in many localities in the British Isles on various occasions, and which are not considered referable to any of the yellow-legged races such as *omissus* or *cachinnans*. BRYAN L. SAGE

[Readers may remember that for some years Mr. Sage has been collecting records of albinism and melanism in British birds (see *antea*, vol. xlix, p. 512). Apart from the records referred to above, we have been sent a few other reports of birds with yellow legs or bills; these and any others we receive are being passed to Mr. Sage; some may later be published—EDS.]

**White-winged Black Tern in Lincolnshire.**—On the morning of 17th August 1957, at Grantham sewage-farm, Lincolnshire, we were watching a small party of Black Terns (*Chlidonias niger*), all either immatures or adults in an advanced stage of moult. Then we saw that one lacked the characteristic "shoulder-mark" and had a noticeably white appearance. During the next hour we made the following notes, with the bird sometimes as close as 20 yards:

Feeding-habits and flight exactly the same as the Black Terns. Crown black; forehead white; back moulting from a dark colour; tail, rump and forepart of wings white, with a trace of grey on top of the carpal joint. Under-parts completely white and under-wing light; no sign of a "shoulder-mark". Legs noticeably red, but beak blackish.

Its white appearance contrasted very strikingly with the grey of the Black Terns. After reference to the *Field Guide* and *The Handbook* we decided that it was a White-winged Black Tern (*Ch. leucopterus*), presumably an adult in moult.

It was also seen later by W. M. Peet and C. T. Beverley and it remained at the sewage-farm until 21st August.

D. G. H. WEST and P. B. HAYWOOD

[What was probably another White-winged Black Tern was

seen at Bardney, Lincolnshire, by W. M. Peet (who also saw the Grantham bird), R. K. Cornwallis and others, on 18th August 1957. The two localities are only some 35 miles apart. However, this second bird was evidently in almost complete winter plumage, so that it was impossible to be absolutely certain that it was not a Whiskered Tern (*Ch. hybrida*), even though this would perhaps be a very unlikely coincidence.—EDS.]

**White-winged Black Tern in Kent.**—At 11 a.m. on 13th June 1956, at New Romney, Kent, the Rev. E. D. Sedding and I found a White-winged Black Tern (*Chlidonias leucopterus*), in full summer plumage, flying over the ponds there. We watched it for some time before leaving the area and it was still there when we returned in the evening, at about 5.30 p.m., whereupon we telephoned Mr. W. S. Nevin who, with Miss H. M. Rowland, was able to watch it for some two hours from 7.0 p.m. The following details are combined from the notes of all the observers concerned:

The head, back, breast, belly and axillaries were all black, contrasting with the rump, upper and lower tail-coverts and tail, which were pure white. The foreparts of the wings were white above and black, or nearly black, below, while the primaries and secondaries were grey. The legs were dull reddish, and the beak was black with a little red at the base (H.M.R., W.S.N.).

In the evening the bird spent some time on the grass at the edge of the ponds, and gave H.M.R. and W.S.N. a particularly fine opportunity to study the plumage. A. C. CAWSTON

**White-winged Black Tern in Sussex.**—At about 7.35 a.m. on 15th June 1956, while I was standing on the sea-front at Hove, Sussex, a small tern passed in a westerly direction, flying approximately 300-400 yards offshore. The visibility was perfect and the following points were noted before the bird was out of range:

The head, under-parts and back were jet black, with the rump and tail pure white in direct contrast. The wings appeared to be whitish, with some darker marks on the primaries and on the inner wing (the exact position of the marks on the inner wing was not determined in the short time concerned). The under-sides of the primaries were quite pale, but the colour of the rest of the under-wing was not noted. The flight was direct and purposeful, though with not quite the buoyancy of a sea tern (*Sterna* spp.)

The contrasting black and white, of the back compared with the rump and tail, could be seen from a great distance as the bird disappeared to the west. I realised that it was undoubtedly a White-winged Black Tern (*Chlidonias leucopterus*) and, on reporting it, learnt of the one that had been seen at New Romney, Kent, two days earlier. GERALD A. SUTTON

**The song-period of the Woodpigeon in Flintshire.**—In *Birds and Mammals of Shetland* (1955) we drew attention to the short song-period of the small local population of Woodpigeons (*Columba*

*palumbus*), which lasts only from early April until early July. We compared this with the period given for central and southern England in *The Handbook*, which shows song in every month of the year and the period of regular song extending from mid-February to the end of September.

However, after four years' residence in rural Flintshire, North Wales, we find the song-period there considerably shorter and, except for a few notes by one bird on 15th November, we have failed to hear any winter song at all.

Our earliest song date is 3rd March, but it is the end of that month or even early April before one can expect to hear a few birds each day. The volume of song is only really large from the latter half of June until about mid-August after which it begins to fade away, finally ceasing during the first half of October.

An isolated pair reared three broods in a thick hawthorn (*Crataegus* sp.) a few yards from our house in Flintshire. Song began on 28th March but was seldom heard after the third week of April. The last song (and by then it was extremely rare) was heard on 14th August, but it was not until 16th September that the third clutch of eggs hatched. L. S. V. and U. M. VENABLES

## LETTERS

### FLATFLIES WANTED.

SIRS,—I should be most grateful if anyone who has any specimens of flatflies (Hippoboscidae), taken from birds, would lend or give them to me for examination connected with my research at the Department of Zoology, University of Hull, Yorkshire. Postage will be refunded. D. S. HILL

**"Information wanted on Lapwing chicks".**—In connection with Mr. P. A. Rayfield's letter on the question of the growth and development of young Lapwings (*Vanellus vanellus*) which appeared in our last issue (*antea*, pp. 128-129), A.W.B. writes as follows:

"As K. G. Spencer pointed out in his *The Lapwing in Britain* (1953), this bird normally sites its nest on bare dry ground from which it can keep an easy look-out in all directions, and the camouflage of eggs and young is obviously based on this type of nest-site. It is evident, therefore, that the time most favourable for breeding is that chosen by the Lapwing after thousands of years of trial—the end of March and the first half of April, before the growth of crops and grasses tends to obscure the sitting bird's view and to nullify the value of the disruptive camouflage of eggs and chicks. It will have been noticed that if crops have grown by some inches while the bird was sitting, the young when hatched are at once led to close-cropped pasture or other bare ground.

"The argument raised in Parliament that it would be a benefit to the birds to take their first eggs, and so make them lay again in more favourable conditions, was, therefore, clearly based on a fallacy; but, nevertheless, it led to the change from the old law of complete protection for this species to one that allowed eggs to be taken until 15th April. Mr. P. A. Rayfield's observations seem to indicate that the bird does know best when to lay, and the outcome of his enquiry may vindicate its behaviour and choice of nesting-period".

# REQUESTS FOR INFORMATION

## THE 1957 IRRUPTIONS OF TITS AND OTHER SPECIES : INTERIM REPORT

In view of the great interest in the irruptions of tits (*Parus* spp.) and certain other birds in the autumn of 1957 (*antea*, p. 130; and vol. I, pp. 495 and 542), we asked the organizers of the analysis—Messrs. S. Cramp, A. Pettet and J. T. R. Sharrock—to prepare a very brief summary of the general picture, as it appears at this stage, indicating some of the points on which information is still particularly needed. They have kindly provided the paragraphs which follow, as a final appeal for observations. It must be emphasized that this is an incomplete picture and some tentative remarks may have to be altered when all the data have been analysed.

From the information so far received, it appears that the movements began with the wanderings of British tits—especially Blue (*P. caeruleus*), but also other species—in the late summer of 1957. It is probable that in many areas more tits than usual had bred, because of a high survival rate in the preceding mild winter, and the increased numbers resulting were noted in many localities in August and early September, mainly in the south-east, but also in some parts of northern England and the Midlands. The first invasions from the Continent were seen on the coast of S.E. England in mid-September, involving mainly Blue Tits, with a few Coal (*P. ater*). A second and somewhat larger influx occurred on 27th and 28th September, still mainly in the south-east, but movements at the end of the month in Flint, Shropshire and at Hilbre Island on the west coast may indicate that some birds had passed through the country. There had been little evidence of tits on the east coast at this date. The third and largest influx began in S.E. England on 4th October, reaching a dramatic peak on the 6th, when birds were seen moving in hundreds in many places along the east and south coast, particularly in Kent, Hampshire, Dorset and Lincolnshire, but extending up to Northumberland and Teesmouth and round to the Scillies. Blue Tits were still the main species, with smaller totals of Coal, but Great Tits (*P. major*) now made their first appearance in large numbers and small parties of Long-tailed Tits (*Aegithalos caudatus*) were also seen. Numbers dropped considerably on the east and south coasts on the 7th, but conspicuous movements were reported on the west coast, from Cornwall to Lancashire and Cheshire, continuing until the 10th. In Ireland there was an influx at Saltee off Co. Wexford then, and on the 14th large numbers of tits were reported from Co. Kerry.

In early October many inland areas of England also reported increases, and attacks on milk-bottles began in many districts or became more frequent where the habit was already known, while paper-tearing, putty-pecking, etc., which had been started by some British tits in September, reached an extent unknown since the last major invasion in 1949 (which, incidentally, went largely unrecorded). Movements continued along the east, south and west coasts from the middle of October until the end of the month, still involving mainly Blue Tits, but with large numbers of Great Tits, considerable but declining numbers of Coal Tits, and occasional parties of Long-tailed Tits. The coastal influx appears to have ceased in early November, but movements continued in many inland localities throughout that month. By December, however, large-scale movement had probably ended and although a few areas in the south reported smaller numbers than usual, in most districts the tit population was said to be well above average, suggesting that the surplus had been spread generally throughout England and Wales, and probably parts of eastern Ireland (but not apparently Scotland). This suggestion of a generally north-and-westerly dispersal is supported both by visual observations (though coastal movements were complicated in some areas and more data on inland movements are needed, especially definite identifications of Continental forms) and by the ringing returns, which reveal many more long-distance recoveries than usual, nearly all between west and north-north-east.

More recently, in late January, February and March 1958, there have been

further reports of increases in a few districts and this suggests a return movement, but more information on changes in numbers in these months is desirable and any coastal observations during this period are also wanted. Similarly, although paper-tearing, putty-pecking, etc., ceased abruptly with the first cold weather in many areas, in other districts there were fresh outbreaks in January and later, and more data on the first and last dates for these outbreaks are required.

Only a brief report can be given on other species. Redpolls (*Carduelis flammea*) were seen on the coast at least a week earlier than the tits, and movements reached a peak in the fourth week of September; they were confined mainly to the coast between Lincolnshire and Dorset. Siskins (*C. spinus*) were reported mainly from the same areas, with the peak in the second and third weeks of September. The influx of Tree Sparrows (*Passer montanus*) continued for a longer period, again mainly in the south-east, though it seems possible that some may have been overlooked elsewhere. Most coastal reports of movements of Jays (*Garrulus glandarius*) were also from the south-east, but isolated inland records from Flint, Oxfordshire and Devon suggest wider movements which have not so far been fully reported. There are scattered reports of increases and movements of many other species, including Dunnocks (*Prunella modularis*), Great Spotted Woodpeckers (*Dendrocopos major*), Goldcrests (*Regulus regulus*), Nuthatches (*Sitta europaea*), Bullfinches (*Pyrrhula pyrrhula*), Wrens (*Troglodytes troglodytes*) and Treecreepers (*Certhia familiaris*), and again more information is required if the full picture is to be clear. All observations should be sent (as soon as possible, please) to Messrs. A. Pettet and J. T. R. Sharrock, Botany Department, University of Southampton.

#### FIELD INVESTIGATIONS OF THE B.T.O.

As already announced (*antea*, p. 39), the Scientific Advisory Committee of the British Trust for Ornithology and the editors of *British Birds* have recently decided to give reciprocal facilities to each other for publicising, in *Bird Study* and *British Birds* respectively, the analyses organised by this magazine and the investigations of the Trust.

**Sample census of heronries.**—Although announcements will not normally be made here about the permanent enquiries run by the B.T.O., which include the Bird-Ringing Scheme, the Nest Record Scheme and Sample Census of Heronies, we take this opportunity of saying that the organisation of the last of these has now been taken over by J. Stafford, Westering, Moor Lane, Brighthstone, Isle of Wight. Those able to count heronries between 15th April and 10th May (or until the end of May in Scotland) are invited to contact Mr. Stafford.

**Roosting-sites.**—For some years the B.T.O. has been collecting data on roosting-sites of all species of birds. There are now some 750 cards relating to 82 species, but in nearly all cases the individual totals are insufficient to warrant any conclusions being drawn and so it has been decided to continue this investigation on a permanent basis. Those who would like to help with observations on roosting-sites are asked to apply to the B.T.O. Office, 2, King Edward Street, Oxford.

**Status of the Wryneck.**—For the last four years a survey into the status of this species in Great Britain has been conducted by Dr. J. F. Monk, Little Stow, Goring, near Reading, Berkshire. It has revealed that the breeding population is probably between 120 and 200 pairs (of which two-thirds are in Kent). However, less than 30 pairs have been *proved* breeding in any one summer, and so it is hoped to make 1958 a "key" year by an all-out effort to locate as many pairs as possible, and to use it as a basis of comparison with a similar survey every five years. All records of Wrynecks, however trivial, are of value in any year, but particularly this year, and should be sent to editors of county bird reports or to Dr. Monk at the end of the summer. Observers who find new localities, or who are in doubt of an identification, should contact other local ornithologists immediately with a view to following up the record throughout the summer.

**Autumn and winter flocks of Coots.**—Information on counts and behaviour, as the winter flocks break up, is wanted by S. McClelland, 62, Torland Road, Hartley, Plymouth (see *antea*, p. 39). This is probably the last season of this enquiry.

**Survey of Black-headed Gull colonies.**—Exactly twenty years ago a survey of Black-headed Gull colonies was organized by P. A. D. Hollom, on behalf of the Trust, and the results were published in *British Birds* (vol. xxxiii, pp. 202-221, 230-244; vol. xxxiv, p. 93). It is clear that many changes have taken place since that time and a new survey is being organized by F. C. Gribble, 42, The Grove, Bedford (England and Wales), and F. D. Hamilton, 4, Bruntsfield Terrace, Edinburgh 10 (Scotland). Readers willing to assist by counting colonies are asked to get in touch with the organizers who will provide special cards on which to enter the details.

## RECENT REPORTS AND NEWS

By I. J. FERGUSON-LEES

**The items here are largely unchecked reports, and must not be regarded as authenticated records. They are selected, on the present writer's judgment alone, from sources generally found to be reliable. Observers' names are usually omitted in case a report is subsequently rejected, and none of the items will be mentioned in our annual Index. Readers are asked to submit anything of interest as quickly as possible.**

The Suffolk Cranes (*Grus grus*) (*antea*, p. 131) were last seen on 2nd March, but a single Crane was reported from Staines, Middlesex, on the 15th and 16th: unlike the birds in East Anglia, however, this was described as "tame". A White-winged Black Tern (*Chlidonias leucopterus*), in almost complete summer plumage, was seen near Llandefeilog, Carmarthenshire, on 8th March. An adult Mediterranean Black-headed Gull (*Larus melanocephalus*) at Brighton, Sussex, on 6th March was possibly a different bird from one seen there on the 16th. Suffolk produced a Kite (*Milvus milvus*) on 4th March (near Brampton) and I have received a preliminary report of a probable one at Kelling, Norfolk, on the 22nd; the only other interesting bird of prey was a Goshawk (*Accipiter gentilis*) in Kirkcudbrightshire on 1st March. Avocets (*Recurvirostra avosetta*) now winter regularly in Devon and to a lesser extent elsewhere in the south (e.g. Kent), but one at Budle Bay, Northumberland, from 16th February until at least 16th March is noteworthy. A drake Ferruginous Duck (*Aythya nyroca*) has been seen regularly near Norwich, Norfolk, since 16th March and two male Red-crested Pochards (*Netta rufina*) were reported from Stanford reservoir, near Rugby, Warwickshire, on the 4th (*cf. antea*, p. 132). Further reports of inland Long-tailed Ducks (*Clangula hyemalis*) continue to straggle in, and the total of counties has been brought to eleven by the addition of Surrey (one near Godalming on 15th December) and Perthshire (one on Faskally Loch on 28th and 29th December). Further reports suggesting an influx of Stonechats (*Saxicola torquata*) on 16th February (*antea*, p. 132) have been received from Norfolk, Surrey and Hertfordshire, and an observation from the Somerset coast indicates a movement there on 2nd March; in addition, Mr. E. D. H. Johnson, who is making a special study of this species, reports a definite passage of distinctly-plumaged Stonechats in Jersey, Channel Islands, between 9th and 16th March; please send any further relevant observations to him at Crabièrre Cottage, Route des Mielles, St. Ouen, Jersey. The Firecrest (*Regulus ignicapillus*) at Aymestrey, Herefordshire—referred to last month (*antea*, p. 132)—was reported again on 2nd and 23rd March.

The bitterly cold weather which persisted throughout Britain from the first week of March until the 23rd evidently held up the arrivals of summer-visitors and very few were reported during this period, though Wheatears (*Oenanthe oenanthe*), Chiffchaffs (*Phylloscopus collybita*), smaller numbers of other species, including a few normally later ones like House Martin (*Delichon urbica*), came with a rush as soon as the milder weather returned. However, before the onset of the cold spell several early migrants were reported and the following perhaps particularly deserve mention: a Sandwich Tern (*Sterna sandwicensis*) in Sussex on 23rd February; Whinchats (*Saxicola rubetra*) in Kent and Hampshire on 16th February (curiously, the date of the Stonechat influx); a Chiffchaff in song in Surrey during 15th-18th and 22nd February, and 5th and 6th March; and a Yellow Wagtail (*Motacilla flava*) in Kent on 9th March.

**SPEND YOUR HOLIDAYS IN A  
BIRD WATCHERS' PARADISE**

**PLACE MANOR**

Nestling in the lush Sub-Tropical  
vegetation of St. Anthony-in-Rose-  
land, on the edge of lovely Percuil  
Creek, with its own five safe sandy  
Bathing Beaches. This peaceful spot  
the outside world has never known;  
is a haven of rest for countless  
numbers of our feathered friends.  
Recent sightings: Pied Flycatcher,  
Mediterranean Warbler, and Goldcrest.

Open all the year round. Ideal for a  
Winter Holiday: **THERE IS NO  
REAL WINTER IN ROSELAND.**

Terms from £5 5s. per week, all  
found. Write for Illustrated Brochure  
to O. Harte, Place Manor, St.  
Anthony-in-Roseland, Portseath,  
Truro. Phone Portscatho 256. Enclose  
medium-sized stamped addressed  
envelope.

**ON THE GLORIOUS  
CORNISH COAST**

**SMALL ADVERTISEMENTS**

9/- for 3 lines (Minimum); 3/- for  
each extra line or part thereof. For  
the use of a Box Number there is an  
extra charge of 1/-.

**BINOCULARS AND TELESCOPES,**  
new and reconditioned, at reasonable  
prices. Approval allowed, also part  
exchanges. Lists from Hatton Optical  
Co. Ltd., Lansdowne, Bournemouth,  
Hants. (Established 1930).

**BINOCULARS AND TELESCOPES,**  
repaired, cleaned and adjusted; send  
your instrument for estimate by return.  
Hatton Optical Co. Ltd., Lansdowne,  
Bournemouth, Hants.

**“CRAIGELLACHIE” GUEST  
HOUSE,** Aviemore. An ornithologists'  
mecca in the Spey Valley. Crested Tit,  
Eagle, Greenshank, etc. Own grounds  
of 12½ acres. Brochure.

9 x 40 Wrayvu Binocular £18/18/0,  
exchanges, repairs, lists. Bass & Bligh,  
18, Market Arcade, Leeds 1.

**THE WEST WALES FIELD SOCIETY**

Membership is open to all who are interested in the study and conserva-  
tion of wild life in Wales. By joining the Society (Fellow: £1 1s.;  
Member: 10s. 6d.), you will receive the quarterly *Nature in Wales* free.  
Your membership card entitles you to join in the field excursions, lectures  
and meetings in the several parts of Wales in which the Society operates.  
It enables you to visit the Society's island sanctuaries and nature reserves  
of St. Margaret's, Skokholm, Grassholm (owned by the Royal Society for  
the Protection of Birds and warded by the W.W.F.S.) and Cardigan  
Island. In order to stay at Skokholm Bird Observatory visitors must  
be members of the W.W.F.S. The activities of the Society include the  
co-operative study by marking (with rings, etc.) of animals, including  
birds and seals, and the recording of their distribution and habits  
in Wales.

*Publications for sale (post free):* ISLAND OF SKOMER, ed. John  
Buxton & R. M. Lockley, 10s. (6s. to members); THE BIRDS OF  
CARMARTHENSHIRE by G. C. S. Ingram & H. Morrey Salmon, 5s.  
(in stiff covers 1s. extra) (4s. to members); A LIST OF PEMBROKE-  
SHIRE PLANTS by F. L. Rees, 3s.; THE FLORA OF ST. DAVID'S  
PENINSULA by C. L. Walton, 3s.; THE SKOKHOLM REPORTS for  
the years up to 1957, 3s. each; NATURE IN WALES, back numbers, 3s.;  
BIRD-RINGING (The art of bird study by individual marking) by  
R. M. Lockley & Rosemary Russell, 10s.

*Address: The West Wales Field Society, Oriulton, Pembroke.*

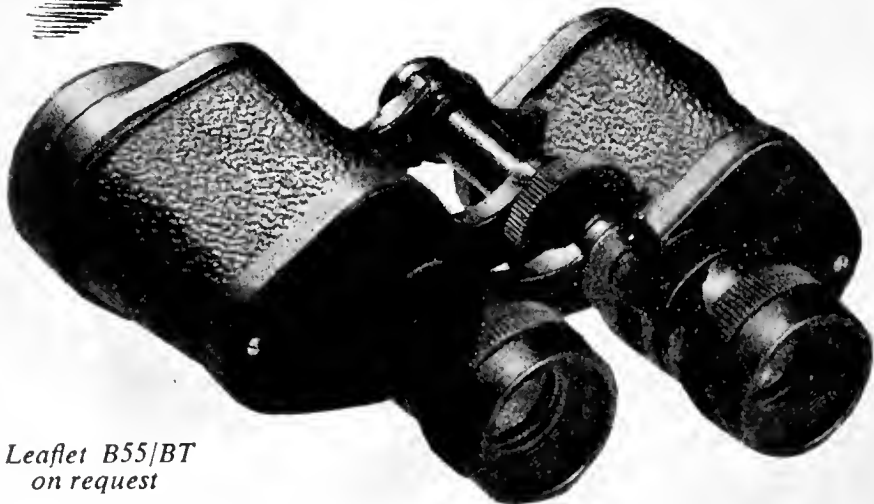
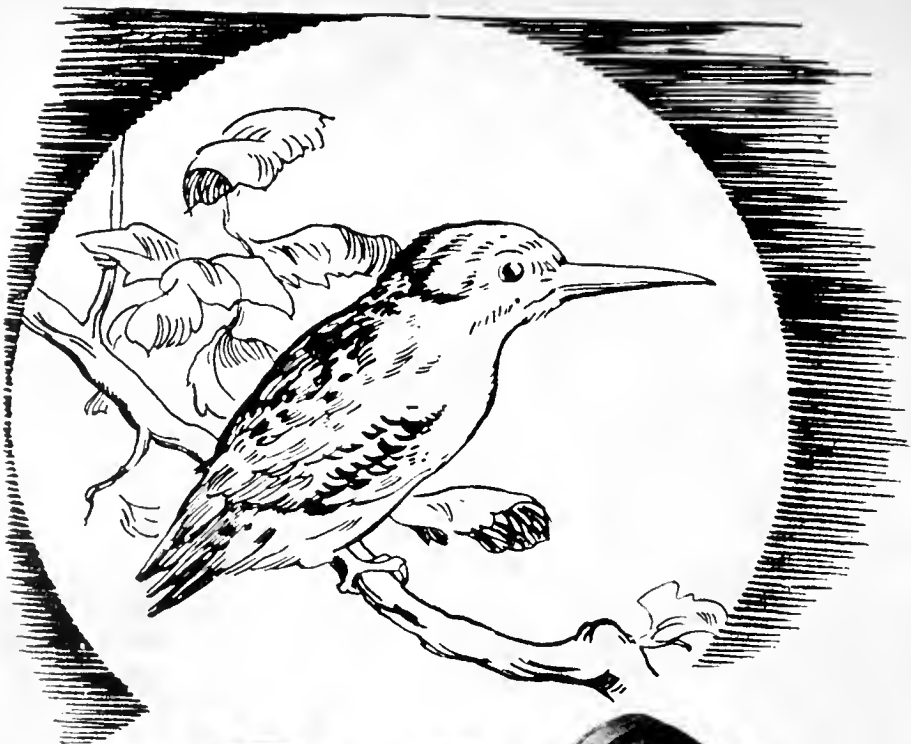

*Leaflet B55/BT  
on request*

Types C.F.18 and C.F.24 (8 × 30.5 mm.) are highly favoured by Bird-watchers, C.F. 24 having an extra wide field of view which is particularly valuable for observing birds in flight. With those who prefer a higher magnification, type C.F. 43 (10 × 42 mm.) is a firm favourite.

*Binoculars by*  
**BARR & STROUD Ltd.**

ANNIESLAND, GLASGOW, W.3 — London Office: 15 Victoria St., S.W.1

*Printed in Gt. Britain by WITHERBY & Co., LTD., WATFORD, HERTS.  
Published by H. F. & G. WITHERBY, LTD., 5, WARWICK COURT, W.C.1.*



# BRITISH BIRDS

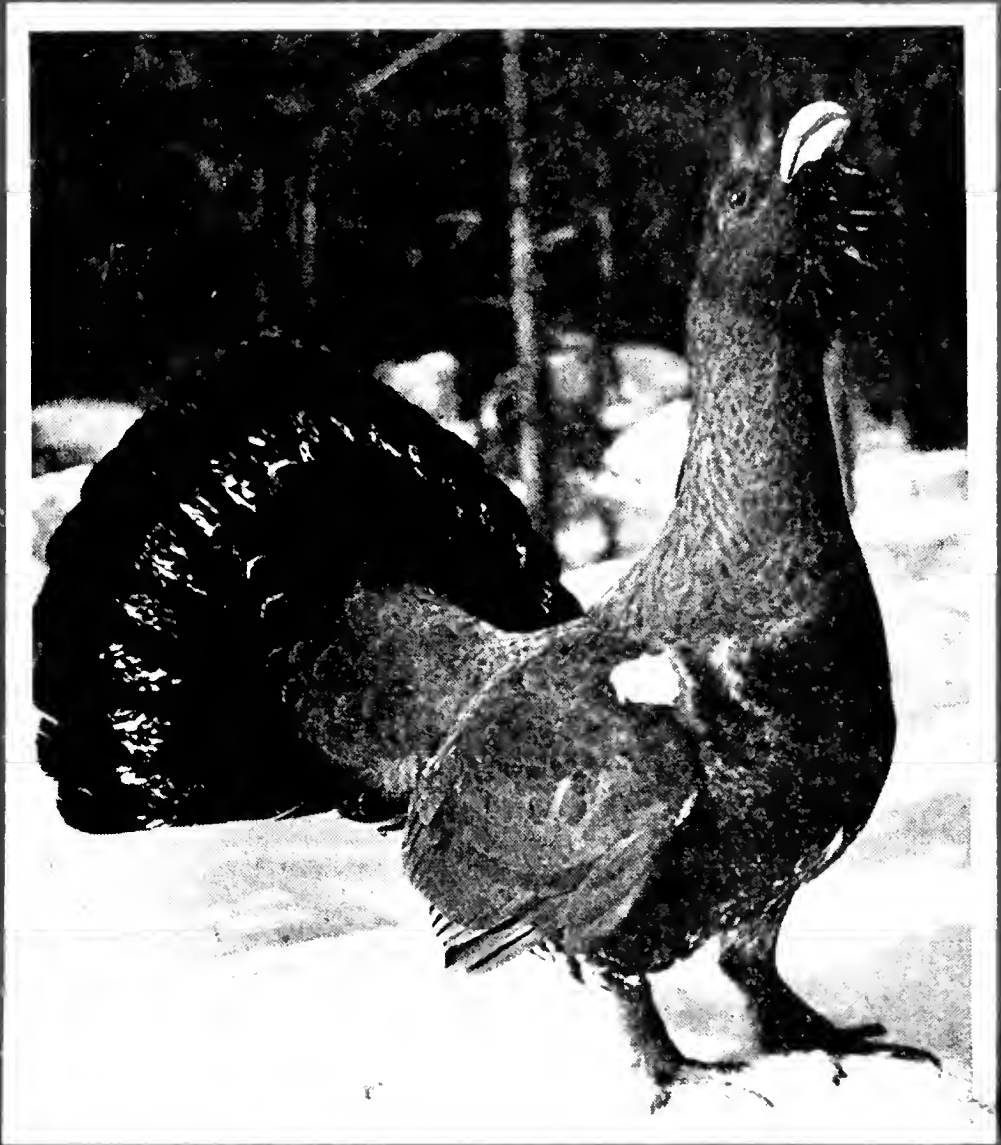

MAY 1958

THREE SHILLINGS

# BRITISH BIRDS

AN ILLUSTRATED MONTHLY MAGAZINE

Edited by

E. M. NICHOLSON

W. B. ALEXANDER                      A. W. BOYD

I. J. FERGUSON-LEES

P. A. D. HOLLON                      N. F. TICEHURST

*Editorial Address* : 30, St. Leonard's Avenue, Bedford.

*Photographic Editor*: G. K. YEATES

Annual Subscription £2 (including postage and despatch)  
payable to H. F. & G. Witherby Ltd., 5, Warwick Court, London, W.C.1

---

---

## CONTENTS OF VOLUME LI, NUMBER 5, MAY 1958

	PAGE
The spring plumage of the Cormorant. By Ralph Stokoe. With photographs by Austin Barton and J. Edelsten (plates 34-35) ... ..	165
The migrations of British falcons (Falconidae) as shown by ringing results. By Sir A. Landsborough Thomson, C.B., D.Sc. ... ..	179
Photographic studies of some less familiar birds. LXXXVIII—Capercaillie. Photographed by Kurt Ellström, Enar Sjöberg and Jonas Svensk (plates 29-32). Text by D. G. Andrew ... ..	189
Notes:—	
Red-breasted Goose in Sussex (P. R. Mills and Dr. A. B. Watson) ...	192
Buff-breasted Sandpiper in Lanarkshire (L. A. Urquhart) ... ..	193
Broad-billed Sandpiper in Hampshire (D. F. Billett and C. J. Henty)	194
Broad-billed Sandpiper in Berkshire (Douglas Carr and C. M. Veysey)	195
Black-throated Thrush at Fair Isle (Peter Davis) (photographed by Mrs. Peter Davis, plate 33) ... ..	195
Pallas's Warbler in Norfolk (Cambridge Bird Club) (photographed by J. L. Cutbill, plate 36) ... ..	197
Thrush Nightingale at Fair Isle (Peter Davis) ... ..	198
Serin at Fair Isle (Peter Davis) ... ..	199
Rustic Bunting at Fair Isle (Peter Davis) ... ..	199
Review:—	
<i>Portrait of a Wilderness</i> . By Guy Mountfort. Illustrated by Eric Hosking ... ..	200
Requests for Information:—	
Field investigations of the British Trust for Ornithology ... ..	202
Recent reports and news. By I. J. Ferguson-Lees ... ..	203

---

Cover photograph by Kurt Ellström, Enar Sjöberg and Jonas Svensk: male Capercaillie (*Tetrao urogallus*) displaying

PURCHASED

30 MAY 1958



VOL. LI

No. 5

MAY

1958



## BRITISH BIRDS

---

### THE SPRING PLUMAGE OF THE CORMORANT

By RALPH STOKOE

(Plates 34-35)

#### INTRODUCTION

THE APPEARANCE in various parts of the British Isles every year, especially in March and April, of a few white-headed birds in flocks of Cormorants (*Phalacrocorax carbo*) has inevitably raised the question of the identification of the Southern race (*Ph. c. sinensis*) and whether it can be distinguished in the field, or at all, from our native bird (*Ph. c. carbo*).

My own interest in the problem was first aroused on 11th March 1951 when two "white-heads" were seen at Bassenthwaite, Cumberland, in a flock of 48 birds. Further observations were made of this and other flocks, until eventually all the wintering and breeding stations on both the Cumberland and the Scottish sides of the Solway Firth, as well as the Farne Islands in Northumberland and haunts further afield, had been visited. In addition to many other detailed counts and comparisons a series of weekly observations, from 30th January to 27th March 1955, was made on a wintering flock near Silloth, Cumberland, to study the development of the spring plumage. In all, over 1,500 birds were examined. Records of observations made in other parts of the country have been sought and collected and have provided a valuable source of information.

The British Museum (Natural History) and the local Carlisle Museum could not produce any skins of British white-heads. It was unlikely that any, or many, had been collected as there are no descriptions of this extreme form of plumage in standard works. Accordingly, four birds were shot at a colony in the Stewartry of Kirkcudbright in April 1956 by Ernest Blezard and myself. These

skins have proved invaluable. They are now in the Carlisle Museum collection.

In what follows, no consideration has been given to birds in any of the various plumages other than that regarded as the adult, of which the glossy black breast and some degree of nuptial adornment in spring are the most obvious features in the field. In describing the appearance of the head and neck I have avoided the rather ambiguous term "hoary".

#### RACIAL CHARACTERS AND DISTRIBUTION

*Carbo*-type Cormorants are described in the literature as having the feathers glossed blue. In "summer" (i.e. nuptial) plumage there is a line of elongated, pointed feathers down the centre of the back of the crown and nape (crest); the crown, neck and throat show, as a transitory feature, a variable number of long, narrow, small, whitish feathers; and at the base of the thigh is a large patch of white feathers of loose structure. In this plumage the sides of the face and the chin (cheek patch) are white instead of brownish-white. *Sinensis*-type birds are distinguished by being glossed metallic green instead of blue and by a much greater development, in both number and size, of the white feathers on the head, neck, and throat—these "often almost covering throat and sides of neck and making them white" (Witherby *et al.* 1940).

The illustrations in *The Handbook* (vol. IV, plate 93) carry these distinctions further by showing *sinensis* with a wholly white head and neck, while *carbo* is flecked only on the crown and sides of the neck. Also (a point not mentioned in the text) the thigh patch on *sinensis* is shown as being much larger than that of *carbo*.

Apart from size, which can only be studied with the aid of a large number of skins, the only other distinction made is that of habitat. *Carbo* is regarded as being a bird of coastal waters, visiting fresh waters in winter, but breeding inland only rather sparingly and rarely in trees, which are little used for roosting. On the other hand, *sinensis* is in general, and especially in the breeding season, a bird of inland waters, habitually breeding in trees, even away from water.

It was pointed out by Tucker (1949) that Cormorants with unusually white heads do occur in Britain, but he concluded that, except for occasional visitors to eastern and south-eastern England from the Continent, these are probably only exceptional individuals which approach the average of the more strongly marked race. Dementiev and Gladkov (1951), on the other hand, found the breeding plumages of *carbo* and *sinensis* identical, except for the violet-blue gloss of the former. Harber (1955) commented that the breeding range of *carbo* is very restricted in the Soviet Union, perhaps limiting the comparative material available.

The breeding ranges of the two forms are adjacent; the winter ranges overlap. *Carbo* breeds from the White Sea west and south along the coast of Norway, through Britain, the Faeroes,

Ice-land and Greenland to the east coast of North America as far south as Nova Scotia. *Sinensis* breeds in western Europe from the Baltic and Holland to northern Spain and east across mid and southern Europe and Asia to China, New Guinea and possibly Japan. Dementiev and Gladkov (1951) were unable to assign the birds in Brittany to either race. In winter both races occur on the Atlantic coasts of France, Spain, and Portugal.

#### WHITE HEAD PLUMAGE

##### (1) *Description* (see plate 34 upper).

The white feathers develop on the head and neck of the adult British Cormorant in the early part of spring, and they are variable in size and apparent density. They are smaller and sparser at the edges of the area of growth and on young birds, when they are often reduced to hair-like filoplumes. When developed to the maximum extent they cover the whole head and neck except the white cheek patch and the black feathers bordering this. Thus a black line curves round the cheek patch from behind the eye over the ear-coverts and under the chin. There is no black line in front of the eye. The line is broadest on the ear-coverts and narrowest under the chin. Its shape varies in detail from one individual to another, and on the same bird with the growth of the white feathers.

The parts of the head and neck most densely covered are: (a) the sides of the neck, and (b) the crown, in two patches on either side of the dorsal line, in front of the crest. The least dense parts are: (a) the forehead, (b) the sides of the head between the ear-coverts and nuchal crest, and (c) the throat. The crest always appears black as the long black feathers obscure the white ones growing among them. The white feathers appear first on those parts where they develop most strongly; the side of the neck being the first part to show any white and the forehead the last.

These strap-like white feathers are typically restricted to the head and neck. Perhaps exceptionally, one of the birds shot in Kirkcudbright (no. 4 in Table I) also had a few similar tiny feathers scattered along the fore-edge and in the angle of the elbow of each wing.

##### (2) *Age and sex.*

On each of the four specimens obtained the visible feathers (some remain concealed) in a square inch on each side of the neck were counted. The average visible length and approximate width of feathers in the same area were determined. From these results a "whiteness factor" was calculated, being the approximate area of the white feathers. It is in each case greater than one square inch because it does not allow for the overlapping of the feathers. These results are shown in Table I. A specimen from Sikkim seen at the British Museum had white feathers up to 20 mm. long and 2 mm. wide.

TABLE I—COMPARISON OF FOUR WHITE-HEADED CORMORANTS (*Phalacrocorax carbo*) OBTAINED IN THE STEWARTRY OF KIRKCUDBRIGHT, S.W. SCOTLAND, IN APRIL 1956

	No. 1	No. 2	No. 3	No. 4
Date shot ... ..	3.iv	3.iv	3.iv	15.iv
Sex ... ..	♂	♂	♀	♂
Wing-length (mm.) ... ..	367	351	346	360
No. of white feathers in 1 square inch on side of neck (average of both sides) ...	167	178	195	215
Average visible length of white feathers (mm.)	10.3	9.1	7.7	10.5
Average width of white feathers (mm.) ...	>1	1	<1	>1
Whiteness factor ... ..	2.9	2.5	2.1	3.8

NOTE: The "whiteness factor" was calculated as follows: number of feathers  $\times$  average length (mm.)  $\times$  average width (mm.) divided by 645 (to convert to square inches). In the calculation the width  $< 1$  was taken as equivalent to 0.9 mm. and  $> 1$  as equivalent to 1.1 mm.

On specimen no. 3 only the sides of the neck were all white; most of the white feathers on the rest of the head and neck were not long enough to show. Presumably any bird, having regard to sex, is potentially capable of developing a maximum growth of white feathers, as the number of such feathers is not the most important factor in producing the final effect. What mainly determines the degree of whiteness is the size of the feathers.

Cormorants begin to show a few filoplumes in their second spring and a year later some white feathers, though fewer than an adult (Witherby *et al.*, 1940). It is not unreasonable to expect this process to continue into later life. Stuart (1948) considered that older and more experienced Cormorants were more successful in avoiding danger and it is of interest in this connection that, when collecting our specimens, we failed to shoot any of the whitest-headed birds. Other details from that same paper on the Mochrum colony show that 16% of ringed birds recovered in their fourth or later year (i.e. adults) were in their eighth or later year—an approximate indication of the age composition of the colony which may, however, be distorted by loss of rings through wear and in any case is based on very few returns. In counts there and elsewhere white-heads have made up about 15% of the total adults present on each occasion. It would seem that such birds are the elders of a colony and may be seven or more years old.

The darkest bird in Table I (no. 3) was a female and was not, even at the time, thought to be particularly white-headed. Each of the three whiter birds shot was found to be a male. When comparing the appearance of paired birds the male (the larger bird) was almost always the whiter. In one case where the reverse was true I decided that a young male was mated with an older female, neither being very white.

### (3) Duration.

Field observations are greatly affected by the distance of the

bird, visibility, and the relative directions of wind and sun. The effect of whiteness is to some extent illusory, as is the image in a newspaper picture. The better the view the more noticeable becomes the black background behind the laeing of white. Also the crown, for example, viewed at a more acute angle, can look whiter than the side of the neck. I tried to satisfy myself that birds counted as white-heads had white on the forehead and throat, which develop latest, as well as elsewhere. The increasing whiteness is a gradual process and there is some individual variation in the pattern and relative degree of development. In making observations of the stage of development and counts, I used the terms "black", "flecked", "grey", and "white". Of these the middle two are arbitrary, though not unsatisfactory in practice, while the definition of a white-head has already been given.

The development of the nuptial plumage must be correlated with the start of the nesting season and one would expect that populations which nest earlier become white earlier. Nesting has started as early as February in Holland. In Britain, Scottish birds may be one month later than those in southern England (Witherby *et al.*, 1940); in Galloway in 1956, however, nesting had started well before "the latter half of May to early June" stated for Scotland. Then several nests had incubated eggs on 15th April (Blezard, 1956). On 25th May fledged young and second clutches were seen at a large Ayrshire colony. A similar early start was likely in 1955, all adults having left their winter haunt at Silloth by 10th April. Nevertheless one would expect south coast birds to be in advance of those so much further north.

In the Solway region, on 17th January 1953, one bird had a few white feathers on the side of the neck. By early February some had the whole head and neck flecked. It can be assumed that the most advanced birds at any stage retain their lead, though it has not been possible to follow any one individual through to full plumage. White-heads were first seen on 6th March in 1955 and they formed 14-15% of the adult population during the short period of maximum whiteness. The decline starts early in April on the Solway and, in my experience, no birds are really white by early in May.

Records supplied by editors of regional reports and by correspondents, those on the files of *British Birds* and my own incidental ones have been summarized in Table II. They extend over the years 1944 to 1957. The numbers of observations of white-headed birds are given in weekly totals from 1st February to 23rd May, by counties from Fife clockwise round the coast to Ayrshire, then Dublin. The few sightings outside this period are also included; in all, 127 observations of 190 birds. The most seen on any occasion was "about 6" on 30th March 1956 at Bempton, Yorkshire. There are two records of 5, five of 4, and five of 3 birds.

TABLE II—SUMMARY OF OBSERVATIONS OF WHITE-HEADED CORMORANTS (*Phalacrocorax carbo*) IN THE BRITISH ISLES

These are gathered from various sources, published and unpublished (see page 169), and illustrate the seasonal nature of the white feathering (though the rapid fall after 4th April is due to the departure of wintering birds for their more remote breeding stations). The letters in parentheses after the names of certain counties refer to the foot-notes.

Week ended	Jan.			February			March			April			May			June-Oct.	Totals
	7	14	21	28	7	14	21	28	4	11	18	25	2	9	16		
Fife ...									1								4
West Lothian ...								1									1
East Lothian ...									1								1
Northumberland (a) ...									1		1						3
Yorkshire (b) ...			2	1	1	1	1	3	4	2	1	1					17
Norfolk (c) ...			1	2	1	1	3	2	2	1							14
																	1 (25.vii) 1 (4.viii)
Suffolk (d) ...									1								1
Essex ...			1		1	2	2		1			1	1				10
Middlesex ...									1								2
Kent (e) ...			1	3	3	4	2			2							19
Sussex (f) ...																	1 (17.viii)
Hampshire (g) ...			1	2	1	2	1	3	1								12
Dorset (h) ...									1			1					2
Channel Islands (i) ...																	1
Devon ...					1												2
Gloucestershire ...						3											1
Pembrokeshire ...								1									4
Shropshire ...						1											1
Staffordshire ...			1					1	2	1							2
Caernarvonshire (j) ...										1							5
Anglesey ...																	1
Cheshire (k) ...					1				1	1		1					2
																	7
																	1 (7.ix) 1 (24.x)
Cumberland (l) ...																	2
Kirkcudbright ...						1	2	2	1	1							8
Ayrshire ...								1	1	1					1		4
Co. Dublin ...																	2
								2	1	1							4
TOTALS ...	3	3	3	8	7	12	15	12	18	19	7	6	4	2	1	1	127

NOTES: (a) "Other reports frequently received."

(b) Birds with grey heads also seen from 14th February to 27th April.

(c) The following were dead birds with a green sheen: 28.ii.54 (winter plumage); 25.vii.54 (immature); 4.ix.55.

(d) No details of other records for 1951 and 1955. Also see Table III.

(e) The following specimens were regarded as *sinezis*: 25.x.35 (immature); 11.ix.46 (immature ♀); 22.ix.46 (immature ♀ and adult ♀); 29.ix.46 (immature ♀); 16.ii.47 (immature); 13.ii.52 (adult ♀); 22.ix.54; 22.xii.54. Also see Table III.

(f) The following specimen was regarded as *sinezis*: 12.ii.38 (immature ♂). White-headed birds have been seen in January, February and March, but I have no details (except as shown at foot of opposite page). Also see Table III.

(g) See Table III.

(h) See Table III.

(i) See Table III.

(j) A white-headed bird was seen at a nest in April 1955.

(k) The bird seen on 24.x. was not completely white, but markedly so.

(l) See Table III.



These totals are shown in histogram form in Fig. 1(a). Using the numbers of *birds* seen instead of the numbers of observations gives a similar result, but with the peaks higher. As the records are made by many different observers working independently a broader definition of a white-head than that which I came to adopt is inevitable: the effect of this is to extend the apparent period of occurrence. The most striking feature of the histogram is the rapid fall after 4th April. This is due to the departure of wintering birds for their more remote breeding stations.

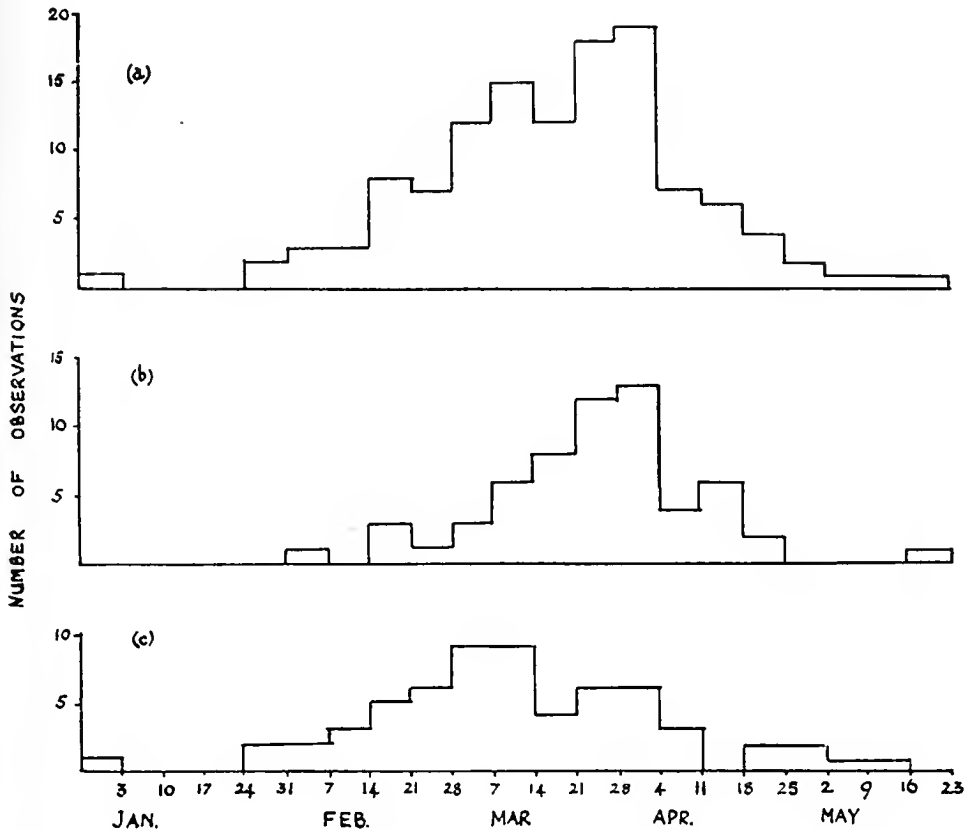

FIG. 1.—THE INCIDENCE OF WHITE-HEADED CORMORANTS (*Phalacrocorax carbo*) IN BRITAIN

The top histogram (a) shows in weekly totals the number of observations of white-headed Cormorants in Britain, as detailed in Table II. The lower histograms show the number of observations in the areas north (b) and south (c) of the Humber (or Wash) and Severn estuaries; thus the bottom figure includes the records for the coastline from Lincolnshire round to N. Devon, with the Channel Islands, and the middle figure the remainder.

Since the preparation of Table II and Fig. 1 the following additional records have been received:

Aberdeenshire	1 (18.iii.46)	Caernarvonshire	1 (29.iii.47)
Essex ...	1 (1.iv.45)	Wigtownshire	1 (19.iv.46)
Sussex ...	1 (23.ii.47) & 2.iii.47)	Co. Dublin	1 (30.iii.48 & 8.iv.48)
Pembrokeshire	1 (26.iii.49)	Co. Cork	1 (10.iii.46)

In sections (b) and (c) of Fig. 1 the weekly totals have been split into two nearly equal parts: respectively north (62) and south (65) of the Humber (or Wash, as there are no observations from Lincolnshire) and Severn estuaries. Fig. 1(b) shows the rapid build-up and the period of maximum whiteness, 22nd March-4th April, before the departure to breeding stations. All the observations during the week ended 18th April were made at, or near, breeding colonies. Fig. 1(c) shows a much wider spread, two or more populations being involved, with a build-up to the higher peak of 1st-14th March and then the lower peak, corresponding to the northern one, of 22nd March-4th April. Dutch birds may be in full plumage in January (C. M. Korteweg, personal communication) which one would expect if they were nesting in February; though so early a start may not be usual they have normally returned by then. The peak of 1st-14th March is presumably of south-country birds.

The statements that the white head-feathers (and thigh patch) are acquired with the spring moult in February-March and that they are lost in the extended post-nesting moult in July-November (Witherby *et al.*, 1940; Tucker, 1949) require amendment. They take about two months to develop fully and must be starting to show in late December in the south, as they are in mid-January on the Solway. The exceptionally early white-head seen in Essex on 3rd January 1953 would be showing traces of white early in November; it was almost certainly a Continental bird.

More remarkable is the rapid disappearance of these plumes. Towards the end of May 1952 at the Farne Islands, Northumberland, in a colony of 300 birds, very few had any white showing. The specimens obtained in Kirkcudbright in April 1956 showed no signs of wear and it seems extremely unlikely that wear, even allowing for the rigours of the nesting period, could have so quick and uniform an action. The appearance of the cheek patch of specimens 3 and 4 (see plate 34 upper) suggests the answer. Both show the start of a moult on a small area of the cheek patch nearest to the eye where brownish feathers have appeared. This moult was almost complete on many of the Farne Islands birds referred to (see plate 34 lower) on which the white head-feathers had also been shed. The female from Kirkcudbright (specimen no. 3) had not started to lay, though it was nearly ready to do so. The nuptial adornments are therefore lost in a moult which begins at the start of the nesting season and which can be complete before nesting is over. The thigh patch remains visible longer, though reduced in size. Other examples of British nesting species in which something similar takes place are the Shag (*Ph. aristotelis*), whose crest loses its first grotesque magnificence very early in the nesting season, and the Sandwich Tern (*Sterna sandvicensis*) which may be white-crowned before incubation is complete.

Occasional birds showing a good deal of white have been seen in July, August, September and October. They must be individuals which for some reason have failed to moult, thus demonstrating the durability of the nuptial plumage.

#### THIGH PATCH

The white feathers of the thigh patch, though larger and broader, resemble those of the head in several respects: they have a similar loose texture; they lie over and hide the black feathers among which they grow from three distinct tracts; and they are affected by the same processes of growth and moult. Being composed of larger feathers and forming a bolder mark, the patch is in evidence for a longer period, but by May it is greatly reduced in size. The first few thigh feathers may be noticed about the same time as the head feathers begin to appear.

A number of observers have noticed that white-headed birds have a larger thigh patch and from a detailed study in 1955 I satisfied myself that this was so. At each visit, the whitest birds had the largest patches, up to the grey-headed stage. Thereafter white- and grey-heads had equally large patches.

#### GLOSS

This is the most critical of the characters and is regarded as the main plumage distinction between *carbo* and *sinensis*. It is also the most difficult to observe and assess. In the field the most favourable conditions of light and distance are necessary; even in the hand the colour of the gloss is not always easy to describe. The quality and direction of the light source are of importance. A greenish gloss, with a light behind the observer, can look bluer when viewed into the light. So as to be sure of the reliability of my observations I had the colour sensitivity of my eyes checked.

Of all the birds seen in the field for which I was able to record the gloss colour, including 42 for which all characters were studied in great detail, only 4 had a satisfactory blue gloss. These four were seen among greenish-glossed birds under identical conditions. Some of these birds were seen at distances as close as twelve feet, in full sunlight. The four specimens shot were checked at the time by Ernest Blezard and myself, and later, when skinned, by several people to whom the significance of the colour was not known. They are all greenish, as, in my experience, are the great majority of our Cormorants.

The colour of the gloss is not brilliant, as with the Shag, and I can only describe it as a dull steel green. There is a varying suggestion of blueness in some birds, which could be described as dull blue-green. I have occasionally caught a vivid flash of green as a bird turned in the sunlight. The colour of the specimens and of those seen in the field is similar to some of the British Museum specimens of *sinensis* (e.g. Punjab, India, 9.ii.1935, ♀) though others were greener (e.g. Bengal, India, 7.xii.1922, ♂).

Too few blue-glossed birds have been seen to decide whether there is any relationship with the degree of development of other characters. Of the four I saw, one was grey-headed, two flecked, and one black. Other observers have mentioned gloss colour: twelve green and four blue.

Although blue and green glosses are stated to be characteristic of *carbo* and *sinensis* respectively (Witherby *et al.*, 1940; Dementiev and Gladkov, 1951) some authors are less definite and also mention blue and purple for *sinensis* (Wardlaw Ramsay, 1923; Baker, 1929). A number of British Museum skins were examined. Those from Britain were purplish or bluish, except the Christchurch *sinensis* skin (February 1873, ♀) which was bluish-green; the Indian ones were green, bluish-green or purplish-green. However most skins were old and all those more than fifty years old, except the Christchurch one, had a purple cast never seen in life. Wagstaffe and Williamson (1947) and Blezard (personal communication) have found that corvine skins undergo a decided colour change with age; the metallic greens and blues becoming more or less purple. I have no doubt that the same process affects Cormorant skins. One doubts the utility of any but the most recent skins in this respect. My own limited experience leads me to the view not only that most of our own Cormorants have a greenish gloss, but also that they are indistinguishable in this respect from *sinensis*. Had the material used by Dementiev and Gladkov (see page 166) not been old, as seems highly probable with the violet-blue gloss described, they might have found the two races identical in all respects, instead of differing only in gloss.

#### SIZE

Briefly, as a discussion of this aspect is not possible on the basis of my limited examination of skins and from published measurements, British Cormorants (wing 325-370 mm.; Witherby *et al.*, 1940) are only slightly larger than those from Belgium (312-367 mm.; Lippens, 1954), but Indian birds are appreciably smaller (315-336 mm.; Baker, 1929). Birds from intervening regions are intermediate in size (e.g. Continental Europe and W. Asia: 322-335 mm.; Ticehurst, 1923).

As mentioned above, it is often possible to distinguish the male from the female in the field by the larger size and more robust build of the former.

#### HABITS AND HABITAT

"Thence up he flew, and on the Tree of Life,  
The middle tree and highest there that grew,  
Sat like a cormorant" [Milton: "Paradise Lost"]

In Britain, the Cormorant, like the Raven (*Corvus corax*), has virtually deserted as breeding areas those parts of the country where trees provide the only nesting sites. The great Norfolk colonies survived until 1825. Subsequent attempts at tree-nesting have

been recorded in Norfolk, Ireland not infrequently, and Kent (Gurney, 1914-15; Upcher, 1916-17; Patterson, 1930; Coward, 1936; Witherby *et al.*, 1940; Gregory, 1944). A colony I saw in Galloway was on an earthy coastal cliff, the upper part of which still retained some of its original vegetation, including bushes, mainly Elder (*Sambucus nigra*) and Willow (*Salix spp.*), up to eight feet high. These held nests, some several, as well as the cliff ledges, both types of nest site thus being in use at the same place.

Cormorants are greatly addicted to the use of elevated perches and will travel considerable distances to satisfy this need. In 1766 one took to using Carlisle Castle, Cumberland, later transferring to the Cathedral from which, after having been fired at upwards of twenty times, it was eventually killed by a person who climbed onto the roof (Heysham, 1794). Persecution continues to be the lot of the Cormorant. Tree roosts are known or have been recorded from Castle Douglas, Kirkcudbrightshire; Dumfriesshire; Windermere, Westmorland; Coniston Water, Lancashire, where a fifty foot spruce has been in use for at least a decade despite intermittent shooting; Aqualate Mere, Staffordshire; Flatford Mill and Holbrook on the Stour estuary, Suffolk; Holkham lake, Norfolk, only two miles from sandbanks; Tal-y-bont, Breconshire; and Syon House, Middlesex (Carruthers, 1939-40; Garnett, 1946; A. F. Airey, *in litt.*; L. A. Cowcill, personal communication; Birmingham and West Midland Bird Report no. 22, 1956; E. A. R. Ennion, personal communication; A. J. Bruce, personal communication).

Birds habitually leave the coast for preferred inland haunts. Distance from the sea is immaterial, e.g. the Staffordshire reservoirs. There are regular winter flocks on several of the lakes in Lakeland. Thus, Cormorants are far from being committed to a marine habitat. This was indicated by the fact that the largest numbers at a fresh-water pond near the Cumberland coast were found during windy weather (Stokoe, 1954).

When these facts are coupled with the known occurrence of *sinensis* in marine habitats and at rock ledge nest sites (e.g. Baker, 1929) it seems clear that there is nothing more in the habitat differences of the two subspecies than that of fluid adaptation to conditions prevailing in the regions where they are able to survive.

#### MOVEMENTS

Many British Cormorants are sedentary and make only local movements in the post-nesting dispersal. Of those which do migrate, most are first-winter birds; perhaps half of these migrate, as well as some older birds. The movement is to the Channel, Biscay and Iberian Atlantic coasts (Witherby *et al.*, 1940). Most ringing recoveries are from Brittany. Out of 170 foreign recoveries up to 30th April 1956, only 6 birds over 12 months old

were found abroad between 1st March and 31st August, as shown in Table III(a). None of these birds was adult and so they are not likely to have been breeding, though immature plumaged birds do occur in nesting colonies.

TABLE III—RECOVERIES OF RINGED CORMORANTS (*Phalacrocorax carbo*) TO INDICATE ANY EXCHANGE OF INDIVIDUALS BETWEEN BRITISH AND CONTINENTAL POPULATIONS

(a) British-ringed Cormorants over 12 months old recovered abroad between 1st March and 31st August (over 160 others were all under a year old, or recovered during the non-breeding months).

<i>Ringed</i>		<i>Recovered</i>		<i>Age in months</i>
3.vii.35	Wigtownshire ... ..	15.viii.36	Gulf of Morbihan, <b>France</b> ...	13
7.vii.35	Northumberland ... ..	18.viii.36	Nr. Lorient, Morbihan, <b>France</b>	13
16.vi.38	Pembrokeshire ... ..	—vii.40	Finistère, <b>France</b> ... ..	25
1.viii.38	Caernarvonshire ... ..	13.iv.40	Vigo, Pontevedra, <b>Spain</b> ...	20
9.vii.50	Anglesey ... ..	1.vi.53	St. Vaast-la-Hougue, Manche, <b>France</b>	35
7.vii.51	Anglesey ... ..	4.iv.53	Vivero, Lugo, <b>Spain</b> ... ..	21

(b) Foreign-ringed Cormorants recovered in Britain.

<i>Ringed</i>		<i>Recovered</i>		<i>Age in months</i>
27.vi.32	Lekkerkerk, nr. Rotterdam, <b>Holland</b>	11.xii.35	Oulton Broad, Suffolk	90+
28.v.33	Isle of Rügen, <b>Germany</b> ... ..	11.ii.36	Newhaven, Sussex ... ..	33
30.v.34	Ditto ( <b>Germany</b> ) ... ..	5.ii.35	Faversham, Kent ... ..	8
26.v.35	Lekkerkerk, nr. Rotterdam, <b>Holland</b>	8.i.36	Studland, Dorset ... ..	7
4.vi.35	Ditto ( <b>Holland</b> ) ... ..	19.iv.36	St. Ouen, Jersey ... ..	10
26.v.37	Meetkerke, nr. Bruges, <b>Belgium</b>	25.vii.38	Faversham, Kent ... ..	14
19.vi.39	Ditto ( <b>Belgium</b> ) ... ..	—vi.45	Hengistbury Head, Hampshire	72
16.vi.46	Horsens Fjord, Jutland, <b>Denmark</b>	1.iii.47	Carlisle, Cumberland ... ..	8

NOTE: All the above were ringed as nestlings, except that on 27.vi.32 at Lekkerkerk, Holland, which was a breeding adult.

Belgian birds, and presumably those from some adjacent parts of western Europe, follow one of two alternative courses. They leave in August and September, returning in February from two distinct winter quarters. One of these is the Channel and the Atlantic coast, as with our British birds, and the other the Rhône estuary/Sardinia/Tunis area of the western Mediterranean (Lippens, 1954). Birds wintering in the former region can be expected to occur on the adjacent shores of Britain on their way down the Channel. A flock moving inland from St. Jean de Luz, Basses Pyrénées, were seen in October (Lack, 1953), so that Mediterranean-bound birds may also use the Channel. Eight foreign-ringed Cormorants had been found in Britain up to 30th April 1956, as shown in Table III(b). One, shot in June 1945 at

Hengistbury Head when six years old, may have been breeding. None is likely to have shown a great deal of white on the head.

#### SUMMARY AND CONCLUSIONS

1. The two European races of the Cormorant are *Phalacrocorax c. carbo* and *Ph. c. sinensis*. The latter is normally separated in the literature on the grounds that it has, in nuptial plumage, a greater amount of white on the head and a larger white thigh patch than *carbo*; that the gloss on its plumage is green, while that of *carbo* is blue; and that it is a tree-nesting form of more inland habitats. In the British Isles *carbo* is the breeding form and *sinensis*—the “Southern Cormorant”—is usually regarded as being probably a regular visitor to the south and east coasts of England. This paper, based on field observations and a small number of specimens collected, discusses the validity of the races and the question of the field identification of “*sinensis*” in the British Isles.

2. In the Solway Firth region (Cumberland and S.W. Scotland), and elsewhere in Britain, there occur Cormorants with extremely white heads; these form up to 14-15% of the adult population. The degree of whiteness increases with age, the whitest birds being the oldest in the colony. The period of maximum whiteness is short and is reached about four weeks before the start of incubation. The white plumes take about two months to develop, and, with the white cheek patch, are lost by a moult which begins about the time the eggs are laid.

3. The thigh patch is larger on white- and grey-headed birds. Being more conspicuous it is visible for a longer period, but the development and loss of the patch coincide with the head plumes.

4. Birds with a blue gloss do occur in the British Isles and they may be commoner in parts of the range of *carbo* from which examples have not been seen, e.g. Iceland and northern Scandinavia (the restricted typical locality), but almost all the birds seen and all the specimens obtained had a greenish gloss similar to some *sinensis* specimens examined.

5. British Cormorants are slightly larger than those from the adjacent coasts of western Europe; Indian birds are appreciably smaller.

6. Any differences in habits and habitat between British and Continental birds are considered to be imposed by local conditions rather than being due to racial differentiation.

7. Many British and Continental Cormorants winter in the same area, but, as yet, the few ringing recoveries do not give much indication of an exchange of individuals between the two populations.

8. Clearly *sinensis* is not separable from *carbo* in the field, if at all. I would suggest that there is a cline of decreasing size and increasing greenness of gloss and whiteness of head from west to east, without a break at the Straits of Dover and Skaggerak.

## ACKNOWLEDGEMENTS

Invaluable advice, encouragement and assistance have been given by Ernest Blezard (whose offer to skin the Cormorants shot, to give one example, can be appreciated only by those who have done so), Austin Barton, Dr. Bruce Campbell, L. A. Cowcill, Dr. E. A. R. Ennion, S. N. Heal, Dr. J. G. Harrison, D. D. Harber, C. M. Korteweg, Robert Spencer and George Trafford, to all of whom I am most grateful. The Bird-Ringing Committee of the British Trust for Ornithology kindly permitted use of the ringing information and the Director of the British Museum (Natural History) examination of the skins.

The observations summarised in Table II were made or made available to me by:

C. M. Acland, L. P. Alder, R. H. Allen, D. G. Andrew, J. W. Andrews, R. W. Arthur, J. C. Backhurst, P. Baird, G. R. Bennett, T. Bispham, E. Blezard, A. W. Boyd, G. L. Boyle, T. E. Brice, G. J. Brown, P. W. P. Browne, A. J. Bruce, H. O. Bunce, J. S. Carter, R. Chislett, P. R. Clarke, F. R. Clifton, F. K. Cobb, E. Cohen, W. M. Condry, W. S. Cowin, F. E. Crackles, J. H. Croke, T. A. W. Davis, H. H. Davis, D. N. Dunn, J. Edelsten, G. Edwards, T. H. Ellis, I. J. Ferguson-Lees, J. W. Gill, E. H. Gillham, M. C. Glasman, J. Goater, J. A. Gulland, F. D. Hamilton, D. D. Harber, E. Hardy, D. F. Harle, S. Hopkins, G. R. Humphreys, H. Hunt, O. D. Hunt, F. E. Kennington, P. D. Kirby, J. Lord, W. G. Luton, M. Macfarlane, K. S. Macgregor, A. T. Macmillan, S. G. Madge, R. V. A. Marshall, S. Martin, M. F. M. Meiklejohn, J. H. B. Munro, I. C. T. Nisbet, P. W. Nolan, D. B. Peakall, R. G. Pettitt, E. E. Preece, C. Popham, G. A. Pyman, R. J. Raines, G. F. B. Robinson, R. F. Ruttledge, H. M. Salmon, A. C. Sawle, J. D. Scott, M. J. Seago, F. R. Smith, K. Smith, J. H. Sparkes, R. Spencer, C. M. Swaine, M. K. Taylor, G. W. Temperley, G. A. Thomason, L. S. V. Venables, J. C. Voysey, H. Walker, G. Waterston, W. B. Watson, N. A. Wesley, I. Whittaker, K. A. Wood and V. C. Wynne-Edwards.

## REFERENCES

- BAKER, E. C. S. (1929): *Fauna of British India (Birds)*. 2nd ed., Vol. VI. London.
- BLEZARD, E. (1956): "Early Cormorant nesting in Kirkcudbright". *Scot. Nat.*, 68: 178.
- CARRUTHERS, O. (1939): "Cormorants roosting in trees in Dumfriesshire". *Brit. Birds*, xxxiii: 26-27.
- COWARD, T. A. (1936): *The Birds of the British Isles and their Eggs*. 5th ed. London.
- DEMENTIEV, G. P. and GLADKOV, N. A. (1951): *The Birds of the Soviet Union*. Vol. 1. Moscow.
- GARNETT, M. (1946): "Water-birds on Windermere—a retrospect". *Trans. Carlisle N.H.S.*, viii: 54.
- GILLHAM, E. H. and HOMES, R. C. (1950): *Birds of the North Kent Marshes*. London.
- GREGORY, T. C. (1944): "Colony of tree-nesting Cormorants in Kent". *Brit. Birds*, xli: 185-186.
- GURNEY, J. H. (1914): "Cormorants nesting in Norfolk". *Brit. Birds*, viii: 52, 130-142.
- HARBER, D. D. (1955): Special review of "The Birds of the Soviet Union". *Brit. Birds*, xlviii: 222.
- HARRISON, J. M. (1947): "Southern Cormorants in Kent and Sussex". *Brit. Birds*, xl: 220-221.
- (1953): *The Birds of Kent*. Vol. I. London.
- HARTERT, E. (1917): "On the European forms of the Cormorant and Little Bustard". *Brit. Birds*, x: 210-214.



- HEYSHAM, J. (1794): "A catalogue of Cumberland animals". In *The History of the County of Cumberland*, by W. Hutchinson. Vol. I.
- HOOKE, W. D. (1953): "Jersey Bird Observatory, 1952". *Brit. Birds*, xlv: 439.
- LACK, D. and E. (1953): "Visible migration through the Pyrénées: an autumn reconnaissance". *Ibis*: 276, 303.
- LIPPENS, L. (1954): "*Les Oiseaux d'Eau de Belgique*". Bruges.
- PATTERSON, A. A. (1930): *A Norfolk Naturalist*. London.
- POPHAM, C. H. (1944): "Southern Cormorant in Hampshire". *Brit. Birds*, xxxviii: 39.
- RIDGWAY, R. (1912): *Color Standards*. 2nd ed. Washington D.C.
- STOKOE, R. (1954): "Siddick Pond and its birds". *Trans. Carlisle N.H.S.*, viii: 61-62.
- STUART, LORD DAVID (1948): "Vital statistics of the Mochrum Cormorant colony". *Brit. Birds*, xli: 194-199.
- TICEHURST, C. B. (1923): "Birds of Sind". *Ibis*, 65: 459.
- TUCKER, B. W. (1949): "Species and subspecies: a review for general ornithologists". *Brit. Birds*, xlii: 203-204.
- UPCHER, H. M. (1916): "Cormorants nesting in Norfolk". *Brit. Birds*, x: 120-121.
- WAGSTAFFE, R., and WILLIAMSON, K. (1947): "Cabinet colour changes in bird-skins and their bearing on racial segregation". *Brit. Birds*, xl: 322-325.
- WARDLAW-RAMSAY, R. G. (1923): *Guide to the Birds of Europe and North Africa*. London.
- WITHERBY, H. F. (1936): "Southern Cormorants in Dorset, Suffolk, Sussex and Kent". *Brit. Birds*, xxix: 358-359.
- *et al.* (1940): *The Handbook of British Birds*. Vol. IV. London.

## THE MIGRATIONS OF BRITISH FALCONS (Falconidae) AS SHOWN BY RINGING RESULTS\*

By A. LANDSBOROUGH THOMSON

THE PURPOSE of this paper is to analyse the recovery of species of the Falconidae ringed in the British Isles under the scheme now managed by the Bird-Ringing Committee of the British Trust for Ornithology and earlier by the late H. F. Witherby, then Editor of *British Birds*. There were no recoveries for any of these species under the former Aberdeen University scheme. Another paper (Thomson, 1958) has already dealt with the hawks (Accipitridae).

The numbers of each of the species concerned that have been ringed and recovered under the scheme are:—

	Ringed to 31.12.56	Recovered to 31.12.57	Percentage recovered
Hobby ... ..	48	4	8.3
Peregrine ... ..	155	(22) 18	11.6
Merlin ... ..	532	(83) 80	15.0
Red-footed Falcon ...	1	—	—
Kestrel ... ..	1,982	(255) 247	12.5

(The recovery figures shown in brackets are those counted before excluding certain records as non-viable, for reasons given later; the reduced totals are used in calculating the percentages.)

\*A publication of the British Trust for Ornithology, the Bird-Ringing Committee of which is indebted to the British Museum (Natural History) for accommodation and ring address and to the Nature Conservancy for financial support.

Recoveries in the British Isles of birds ringed abroad are mentioned. Details have been published in the periodical lists in *British Birds* compiled at first by H. F. Witherby and E. P. Leach and latterly by E. P. Leach alone.

### Hobby (*Falco subbuteo*)

#### *Recoveries of birds ringed as nestlings.*

There are four records. Of 3 birds ringed in Wiltshire, one was recovered on 16th October of its first year, in Landes, France; one on 13th September of its first year, at Espinho, N. Portugal; and one in August of its second year, in Herefordshire, about 100 miles to the north. The fourth bird, ringed in Surrey, was recovered locally within a few weeks.

#### *British recovery of bird ringed abroad.*

One native to Uppsala, Sweden, was recovered in Norfolk in September of its first year.

### Peregrine (*Falco peregrinus*)

#### *Recoveries of birds ringed as nestlings.*

Excluding 4 birds found dead in the nest, there are 18 records. All these are of birds ringed as nestlings (counting one trapped as young on 5th July) in Great Britain (including one in the Isle of Man). The recovery localities can be grouped as follows:—

(a) Local:— 6.

(b) Distances of about 50 miles:— 4, the directions being northerly in 3 cases and south-westerly in the other (Cumberland to Isle of Man).

(c) Distances of the order of 100 miles (actually 85-110):— 5, the directions being northerly in 4 cases (Banffshire to Ross-shire, Cumberland to Ayrshire, Selkirkshire to Kincardineshire, and Westmorland to Perthshire) and south-easterly in the other (Sutherland to Banffshire).

(d) Distances of about 150 miles:— 2, the directions being N.W. and N. (Yorkshire to, respectively, Argyll and Fife).

(e) A distance of over 400 miles:— 1, from Cape Wrath, Sutherland, to Co. Wexford, Eire, in January of its first year—about 420 miles in a direction slightly west of south.

Only the last record, under (e), is suggestive of a real migration. The other distances are small for a bird with such great powers of flight; and northerly directions predominate in this series. No seasonal pattern is discernible, as both the local and distant records relate to all times of year: the Yorkshire bird recovered in Argyll, 152 miles N.W., was described as "shot at the nest"—in April of its fifth year. Nor is there an age pattern; some of the youngest and also the two oldest birds were recovered locally.

6 of the recoveries were in April or May, 3 in August, 4 in October and the rest singly in other months. It is not possible to relate the distribution to reported causes of death, although two records resulted from shooting at the beginning of the breeding season.

The age distribution, in years of life reckoned from 1st April, is:— 5, 5, 2, 1, 3, 0, 0, 1, 1. The last two birds were, respectively, more than seven and (although in the ninth year by the conventional reckoning) actually not quite eight years old.

*British recoveries of birds ringed abroad.*

There are 8 recovery records of birds ringed in the breeding season, mostly as young, in Scandinavia. Of those recovered in the first winter, 2 from the Lofoten Islands, N. Norway, had reached Berkshire and Lincolnshire respectively, one from Swedish Lapland had reached Gloucestershire, and one from Halland, S. Sweden, had reached Devon. The other displacements, recorded in subsequent winters, were from Västergötland, S. Sweden, to Kent; from Västmanland, Sweden, to Kent and to Yorkshire; and from Luleå, N. Sweden, to Shropshire (in its fifth year).

**Merlin** (*Falco columbarius*)

One local record is excluded for lack of a recovery date (in the first summer) and two others because of unnatural circumstances: one bird had been used for falconry subsequent to ringing and the other was ringed after a period of captivity. This leaves 80 recoveries, 69 of birds ringed as nestlings and 11 of birds ringed otherwise; all the ringing localities were in Great Britain.

*Recoveries of birds ringed as nestlings.*

The incidence of the 69 recoveries by season and age, years of life being reckoned from 1st April, is shown in the following table:—

Month	Year of life						Total
	First	Second	Third	Fourth	Fifth	Sixth and over	
April		3	2				5
May			2	3			5
June	1	2	1	1	1		6
July	3	1	1				5
August	9		1		1		11
September	4	2				1 (7th)	7
October	6	1	2	1			10
November	1	1	1				3
December	3	2					5
January	1						1
February	1	2					3
March	1		1			2 (6th; 8th)	4
Uncertain	2	2					4
<b>Total</b>	<b>32</b>	<b>16</b>	<b>11</b>	<b>5</b>	<b>2</b>	<b>3</b>	<b>69</b>

Only 3 were recovered abroad:—

<i>Month of recovery</i>	<i>Native locality</i>	<i>Recovery locality</i>
First year:		
October	Yorkshire	Landes, France
November	Devon	Charente Maritime, France
Sixth year:		
March	Yorkshire	Charente Maritime, France

(A member of the same brood as the first of the above was recovered in Lancashire in its first December.)

Of the 66 recoveries within Great Britain, 46 may be classed as local, being either from the ringing locality or from within a short distance (probably never as much as 40 miles, but in many instances exact ringing localities were suppressed for reasons of discretion). Of the remaining 20, only 8 were from distances of over 80 miles, as follows:—

<i>Recovery date</i>	<i>Displacement (approx., in miles)</i>
First year:	
August ... ..	Within Yorkshire (88 S.E.)
August ... ..	Caithness—Aberdeenshire (100 S.E.)
September ... ..	S. Yorkshire—Berwick-upon-Tweed (165 N.N.W.)
October ... ..	Perthshire—Kirkcudbrightshire (90 S.)
October ... ..	Co. Durham—Dorset (270 S.)
December ... ..	Yorkshire—Shropshire (125 S.)
Third year:	
May ... ..	Yorkshire—Shropshire (112 S.)
Fifth year:	
June ... ..	Yorkshire—Kirkcudbrightshire (96 N.W.)

It will be seen that all but one of the first-year birds had taken southerly directions. The two records for subsequent summers may possibly indicate breeding displacement.

Of the 7 first-year recoveries and 5 later recoveries from distances of between 40 and 80 miles, some are from northerly directions—including two rather over 40 miles from their nests in the first July and first August respectively.

*Recoveries of birds ringed when full-grown.*

There are 2 records of birds ringed otherwise than on migration and recovered locally; and the following 9 records of birds ringed while on migration off the Scottish coast and recovered later in the same season or, in one case, next spring.

	<i>Ringing data</i>		<i>Recovery data</i>	
♀	12.8.56	Fair Isle	30.8.56	Fair Isle
♀	16.9.52	"	3.10.52	Caithness (100 miles S.W.)
♂	15.9.54	"	8.10.54	Landes, France
juv. ♀	18.8.54	"	9.10.54	Kincardineshire (170 S.S.W.)
juv.	3.9.57	"	11.10.57	Bremerhaven, Germany
juv. ♂	18.8.53	"	18.10.53	Liège, Belgium
juv. ♂	28.8.56	"	(20.10.56)	Limburg, Belgium
juv. ♂	19.8.52	"	17.12.52	Perthshire (220 S.S.W.)
juv.	19.10.50	Isle of May	10.3.51	Kirkcudbrightshire (95 S.W.)

*British recoveries of birds ringed abroad.*

Three birds native to Iceland have been recovered in October-December of their first year, in Stirlingshire, Lancashire and Offaly, Eire; and another in April of its fourth year, in Dunbartonshire. (There is also a record of a bird native to Jämtland, Sweden, in its third winter, in Jersey, Channel Islands.)

**Kestrel** (*Falco tinnunculus*)

After excluding 8 records—in which four birds had never flown, two others were recovered locally at early but uncertain dates, one had been transported and was recovered on the day of release, and one (treated separately below) was ringed in the Channel Islands—there are 247 recoveries. Of these, 213 are of birds ringed as nestlings in the British Isles (mainly Great Britain) and 34 of birds ringed as full-grown.

*Recoveries of birds ringed as nestlings.*

The incidence of the recoveries by season and age, years of life being reckoned from 1st April, is shown in the following table:—

Month	Year of life							Total
	First	Second	Third	Fourth	Fifth	Sixth	Seventh and over	
April		6	1	1			1 (7th)	9
May		6	2	5			1 (8th)	14
June		3	2	2		1	2 (9th; 12th)	10
July	12	4	1	1				18
August	25	4	1					30
September	21	3		1	1			26
October	16			1			1 (9th)	18
November	14	1	1	1				17
December	11	4						15
January	17	4	1	1		2		25
February	12	2	1	1	2			18
March	6	2						8
Uncertain	1	3	1					5
Total	135	42	11	14	3	3	5	213

Of the above total, 146 birds were recovered locally or within distances of 50 miles; 49 were recovered at greater distances within the British Isles; and 18 were recovered abroad. One of the birds recovered, locally, in February of its fifth year had also been reported in June of its third (not in table for the earlier date). The oldest bird, 11 years of age, was recovered in June at a locality 76 miles N.N.E. The next three oldest birds ( $8\frac{1}{3}$ , 8 and 7 years) were recovered near their places of birth—the eight-year-old bird was breeding within 200 yards. The relatively large number of recoveries in April, May and June of the second and later years of life is noteworthy—as in the case of the Sparrowhawk (*Accipiter nisus*) (Thomson, 1958).

Of the birds recovered in their first year at distances of 51-100

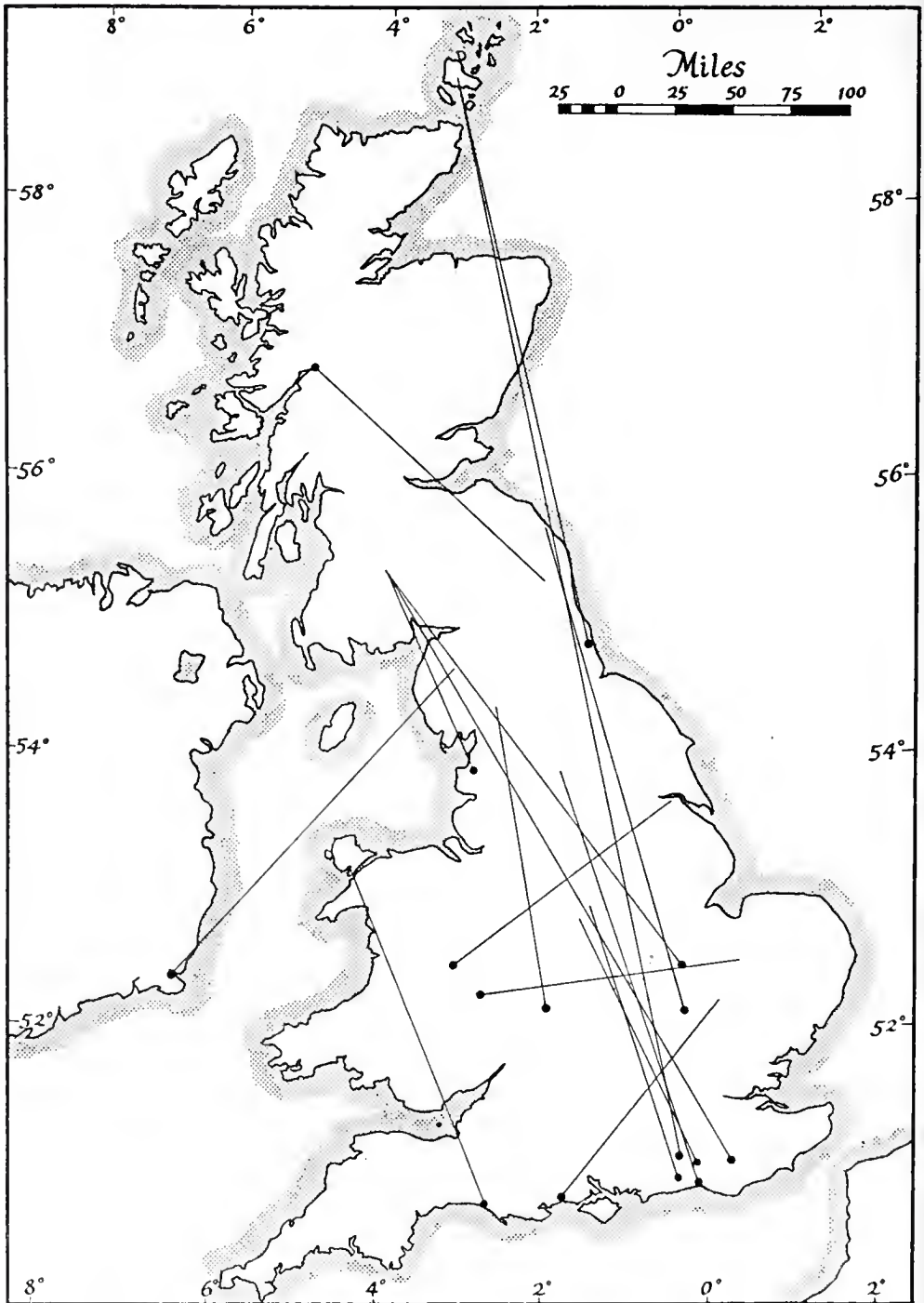

MAP 1—FIRST-WINTER RECOVERIES OF KESTRELS (*Falco tinnunculus*) WITHIN THE BRITISH ISLES

This shows the first-winter displacements (including one record in April of second year) exceeding 100 miles, but within the British Isles, of birds ringed as nestlings (details on page 185). Each spot indicates a recovery locality and the other end of the connecting line the corresponding ringing locality. For recoveries abroad, including those in later years, see Map 2 (page 186).

miles, 11 had travelled in southerly directions, 10 in northerly directions and 1 eastwards; but of birds recovered in their first year (including the next spring) at greater distances within the British Isles—as listed below—15 had travelled in southerly directions and only 1 in a northerly direction (150 miles). This indicates a random dispersal within a radius of up to 100 miles, but a definite migratory tendency in longer flights—of which the recoveries abroad give further evidence.

The following list (see also Map 1) of 21 recoveries within the British Isles is limited to those showing movement (not necessarily complete at the earlier dates) of more than 100 miles:—

<i>Recovery date</i>	<i>Displacement (approx., in miles)</i>
First year:	
July ... ..	Anglesey—Dorset (185 S.S.E.)
August ... ..	Derbyshire—Sussex (140 S.S.E.)
September ... ..	Lincolnshire—Shropshire (140 S.W.)
„ ... ..	Orkney—Sussex (560 S.S.E.)
„ ... ..	Norfolk—Herefordshire (135 W.S.W.)
October ... ..	Northumberland—Bedfordshire (250 S.S.E.)
„ ... ..	Cambridgeshire—Hampshire (130 S.W.)
„ ... ..	Orkney—Co. Durham (300 S.S.E.)
„ ... ..	Dumfriesshire—Sussex (330 S.S.E.)
December ... ..	Dumfriesshire—Huntingdonshire (250 S.E.)
„ ... ..	Derbyshire—Sussex (140 S.S.E.)
January ... ..	Northumberland—Inverness-shire (150 N.W.)
„ ... ..	Yorkshire—Sussex (220 S.S.E.)
„ ... ..	Yorkshire—Warwickshire (150 S.)
February ... ..	Dumfriesshire—Lancashire (115 S.S.E.)
Second year:	
April ... ..	Cumberland—Co. Wexford, Eire (205 S.W.)
December ... ..	Yorkshire—Surrey (285 S.S.E.)
March ... ..	Northumberland—East Lothian (140 N.N.W.)
Fourth year:	
June ... ..	Lancashire—Norfolk (150 S.E.)
Sixth year:	
April ... ..	Northumberland—Aberdeenshire (150 N.)
Uncertain ... ..	Derbyshire—Norfolk (130 E.)

In the case of birds recovered after their first year it is obviously impossible to know what movements had taken place in the interval. The June record suggests displacement of breeding locality.

The following is a complete list (see also Map 2) of recoveries abroad:—

<i>Month of recovery</i>	<i>Native locality</i>	<i>Recovery locality</i>
First year:		
September (25th)	Isle of Man ...	Basses-Pyrénées, France
October ... ..	Yorkshire ...	Sarthe, France
„ ... ..	Yorkshire ...	Eure-et-Loir, France
„ ... ..	Lincolnshire ...	Ostende, Belgium
„ ... ..	Isle of Man ...	E. Flanders, Belgium
November ... ..	Wiltshire ...	Loiret, France
„ ... ..	Lancashire ...	Vendée, France
„ ... ..	Dumfriesshire ...	Loir-et-Cher, France
December ... ..	Surrey ... ..	Cortes, Navarra, Spain
„ ... ..	Buckinghamshire	Indre, France
February ... ..	Berkshire ...	Nord, France
March ... ..	Essex ... ..	Oise, France
„ ... ..	Buckinghamshire	Calvados, France

Second year:

May ...	...	Bedfordshire ...	...	Liège, Belgium
June ...	...	Yorkshire ...	...	Pas-de-Calais, France
January ...	...	Lancashire ...	...	Västergötland, Sweden
March ...	...	Northumberland ...	...	Nord, France

Sixth year:

January ...	...	Lincolnshire ...	...	Eure, France
-------------	-----	------------------	-----	--------------

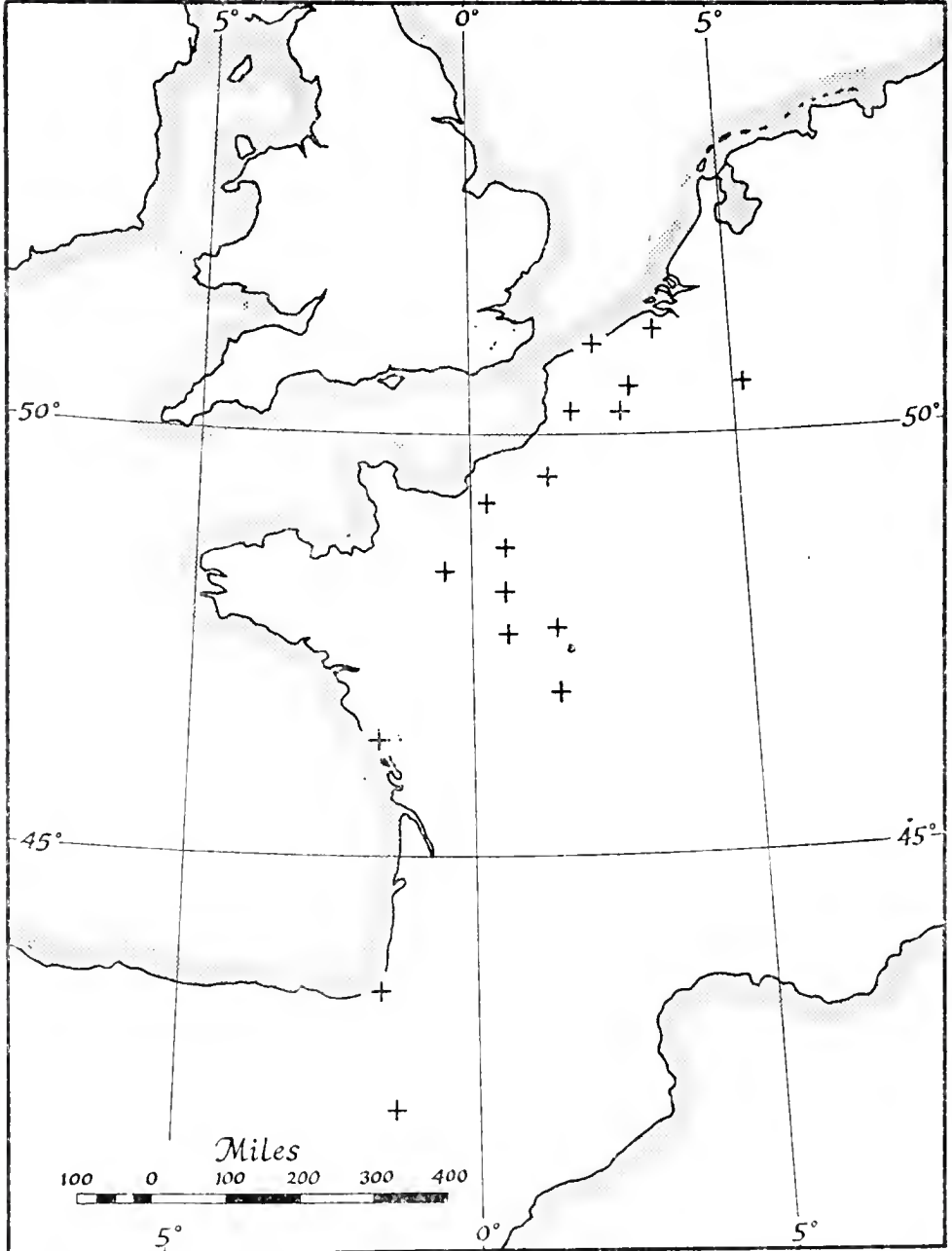

MAP 2—RECOVERIES ABROAD OF BRITISH-RINGED KESTRELS (*Falco tinnunculus*)  
 The seventeen crosses mark the recovery localities abroad, mostly in the first winter, of birds ringed as nestlings in Great Britain and the Isle of Man. There is also an eighteenth record, not shown, of a bird ringed in Lancashire and recovered in its second winter in Västergötland, Sweden (see top of page).





Kurt Ellstrom, Enar Sjöberg and Jonas Svensk

MALE CAPERCAILLIE (*Tetrao urogallus*): SWEDEN, 7TH APRIL 1950

Note the vermiculations on the slate-grey upper-parts, the semi-circle of white markings on the black tail, the large whitish bill, the greenish-black "beard", the brown-feathered tarsus and the white patch on the inner leading edge of the wing. This bird is "singing": a double popping note, slow at first but accelerating rapidly, followed by a single popping sound (the only loud note in the sequence) and then by a hissing and grinding phrase (see page 101).



*Kurt Ellstrom, Einar Sjöberg and Jonas Sjöenski*

MALÉ CAPERCAILLIE (*Tetrao urogallus*): SWEDEN, 7TH APRIL 1950

This is the full song-display posture, with tail fanned and almost vertical, wings drooped, and up-stretched neck "swollen" by the erection of the ruff and the throat-leathers. This "singing" takes place chiefly in the very early morning, starting well before dawn but continuing at intervals up to the middle of the day, in April and May (see page 102). The bare skin over and behind the eye, visible here, is bright red; warm brown wing-coverts contrast with the greys and blacks of the rest of the plumage.



*Kurt Ellstrom, Einar Sjöberg and Jonas Svensk*

MALE CAPERCAILLIE (*Tetrao urogallus*): SWEDEN, 21ST APRIL 1950

This striking outline against the sky illustrates how the song is often uttered from some eminence—a tree, rock or just a small knoll. Note the long, stiff throat-leathers, and the contrast between the grey neck and the glossy band (of green) across the breast.



*Kurt Ellstrom, Einar Sjöberg and Jonas Svensk*

MALE CAPERCAILLIE (*Tetrao urogallus*): SWEDEN, 7TH APRIL 1950

A curious view from the front, the bird's upraised whitish bill and "swollen" neck outlined against the background of the spread tail. Here the place is a snow-covered mound. The band of whitish markings across the distal half of the tail varies enormously among individuals.

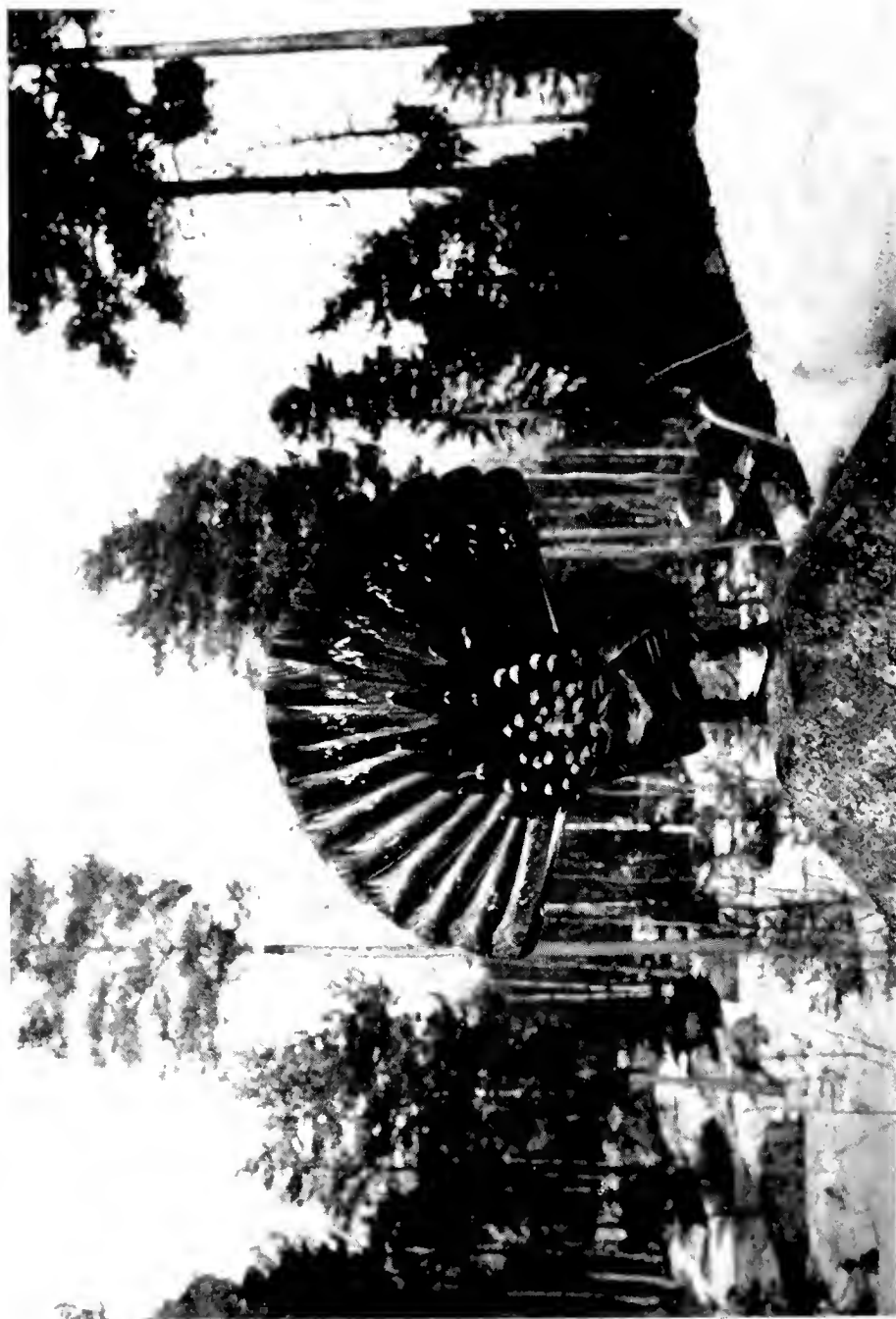

Kurt Ellström, Einar Sjöberg and Jonas Svensk

MALE CAPERCAILLIE (*Tetrao urogallus*) DISPLAYING: SWEDEN, 21ST APRIL 1956

Another unusual view, from the rear, showing how the shorter of the black under tail-coverts are, like the feathers of the belly, broadly tipped with white. The display-place is again a rock and this time one gets an impression of the Capercaillie's habitat—mature coniferous forest, not too dense, with a medium amount of undergrowth. Primarily vegetarian, this bird feeds in the tree-tops in winter, on the conifer shoots, and so is untroubled by snow (see page 189).



*Angela Davis*

MALE Black-throated Thrush (*Turdus ruficollis atrogularis*): Fair Isle, December 1957. This, the fifth British record, was trapped on 8th December 1957 and was seen on the island until about 22nd January 1958 (see page 195). About the size of a Fieldfare (*T. pilaris*), this bird is easily identified by its black throat and upper breast, which contrast with the uniform grey-brown upper-parts, and the dull white lower breast and belly. The female is browner above and has the black area whitish, closely marked with black spots and streaks. In both sexes there is an orange-yellow base to the brown bill.

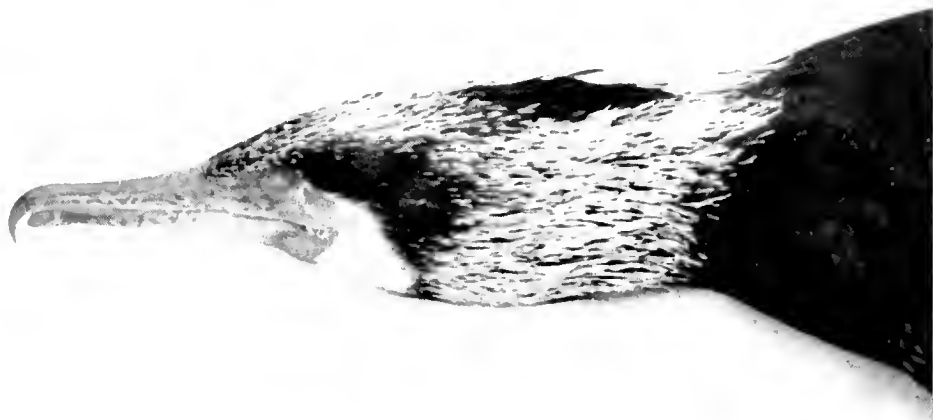

Austin Barton

CORMORANT (*Phalacrocorax carbo*): SHOT KIRKCUDBRIGHT, 15TH APRIL 1956  
This adult male (No. 4 of Table I on page 168) was by no means the whitest-headed in the colony, but it gives some indication of the extent to which British-breeding birds assume this character. The distribution of the white, the nuchal crest (flatter than in life), the cheek patch and the black feathers bordering it are clearly shown. Note that part of the cheek-patch by the eye has been moulted and is browner.



Austin Barton

CORMORANTS (*Phalacrocorax carbo*): NORTHUMBERLAND, 24TH MAY 1952  
By this date most nesting Cormorants have lost all their white head-feathers and the cheek-patches have been almost completely moulted (see "The spring plumage of the Cormorant", pages 165-179).



J. Edelsten

CORMORANT (*Phalacrocorax carbo*): DEL, CHESHIRE, 17TH MARCH 1953

This bird was taken to be a female because it was smaller than its mate which it later joined; the latter was very much whiter on the head and neck. Note the raised nuchal crest.



J. Edelsten

CORMORANT (*Phalacrocorax carbo*): DEL, CHESHIRE, 17TH MARCH 1953

From these two photographs it can be seen that in this individual the white head-plumes were not fully developed and the thigh patch was rather small. On a really white-headed bird not only do the plumes more effectively hide the black feathers, but they cover the forehead down to the base of the bill and are as dense on the sides of the head below the crest as elsewhere (see page 107).



J. L. Cutbill

PALLAS'S WARBLER (*Phylloscopus proregulus*): NORFOLK, NOVEMBER 1957  
This is the third British record (see page 107). The olive-green crown is divided by a pale yellow stripe (barely visible here), while a yellow superciliary and yellow cheeks contrast with a very dark eye-stripe. Note the two yellowish wing-bars, one here partly obscured by ruffled feathers.



J. L. Cutbill

PALLAS'S WARBLER (*Phylloscopus proregulus*): NORFOLK, NOVEMBER 1957  
Note the conspicuous bright yellow rump and uniformly dark tail. Three other *Phylloscopus* species, not on the British list, have yellow rumps and double wing-bars, but two have white in the tail and the third has a different head-pattern and pure white under-parts (see *antea*, vol. xlviii, pp. 206-208).



The Swedish record seems abnormal: one may suppose that the bird migrated in its first autumn, made an aberrant return in spring and remained in its new summer area in its second winter.

*Recoveries of birds ringed when full-grown.*

Of the 34 birds in this category, 24 were recovered at or quite near the place of ringing in circumstances of no particular interest; the intervals ranged from days to  $4\frac{1}{2}$  years. There are 4 other local records: one bird ringed as a juvenile on Skokholm, off Pembrokeshire, on 11th April 1936 was recovered there on 17th August 1936 and again on 5th July 1937—probably a sedentary local bird; one ringed as a young bird in Middlesex on 13th July was recovered in Kent, 23 miles S.E., 13 days later; one ringed as an adult at Spurn Point, Yorkshire, on 14th September was recovered in the same county, 27 miles N.W., 19 days later; and one ringed in Essex in January was recovered in Norfolk, 40 miles N.N.E., in April of the following year.

In 2 other British recoveries there was greater movement: a bird ringed at Spurn Point, Yorkshire, on 28th August was recovered in Cambridgeshire, 65 miles S., on 15th October of the same year; one ringed in Worcestershire in March was recovered on Caldey Island, off Pembrokeshire, in July of the second year following.

The remaining 4, ringed on (inferentially) autumn migration, were recovered abroad as follows:—

		<i>Ringling data</i>	<i>Recovery data</i>	
ad. ♀	27.9.53	Smith's Knoll Lightship (24½ miles E. of Gt. Yarmouth)	13.10.53	Nord, France
ad.	21.8.55	Dungeness, Kent	4.12.55	Charente, France
juv.	27.10.53	Lundy Island, Bristol Channel	13.12.53	Finistère, France
juv. ♀	26.7.50	Fair Isle, Scotland	29.12.50	Loiret, France

*Recovery of a bird ringed outside the area.*

A bird ringed as "young" in July on Jersey, Channel Islands, was recovered in Maine-et-Loire, France, in November of the same year; this case is excluded from total figures.

*British recoveries of birds ringed abroad.*

There are four records of birds ringed on the Continent as nestlings—one from Schouwen, Holland, in East Lothian on 31st August of its first year; one from Valdres, S. Norway, in Co. Kerry, Eire, in October of its first year; one from Silesia in Yorkshire in November of its second year; and one from Friesland, Holland, in Gloucestershire in January of its second year.

One ringed on 30th September in S. Norway when full-grown was recovered on 19th December of the same year in Bedfordshire. One ringed as an adult in October at Antwerp, Belgium, was recovered in June of the third subsequent summer in Yorkshire (conceivably its native area).

SUMMARY

HOBBY.—Birds native to the south of England (Wiltshire) were

recorded in their first autumn, from western France (Landes) and northern Portugal (Espinho), the latter as early as 13th September. A third was recorded in August of its second year, 100 miles north of its birthplace. A Swedish native bird has been recovered in Norfolk in its first autumn.

**PEREGRINE.**—Birds native to Great Britain show a marked tendency to wander, up to distances of about 150 miles, and may breed in the localities thus reached. The directions are probably random, northerly ones in fact predominating in this small series. There is only one record of a longer movement—from N.W. Scotland to S.E. Ireland, about 420 miles, in its first winter. The oldest bird recovered had attained an age of nearly eight years. Scandinavian birds have been recorded in various parts of England in their first and subsequent winters.

**MERLIN.**—Birds ringed as nestlings were recovered in the British Isles in all months of the year, the majority of them locally; of the few showing significant movement (up to 270 miles), the direction taken was southerly in most cases, but not in all; possible breeding displacement of the order of 100 miles was indicated in two cases. The only two foreign recoveries were from France in winter. The oldest bird was in its eighth year.

Birds ringed on migration at Fair Isle in August and September were recovered, later in the same season, on the mainland of Scotland (one in mid-winter), in Belgium (2) and in France (1). Birds native to Iceland have been recovered in the British Isles in their first winter and in a later spring.

**KESTREL.**—Many of the British birds are sedentary, as shown by local recoveries throughout the year and at all ages. At least in the first autumn there is random dispersal, within a radius of up to 100 miles, on the part of some. Others show a more definite tendency to southerly migration, but—as shown by mid-winter recoveries at distances of some hundreds of miles—not necessarily beyond the limits of Great Britain. There are, however, records of emigration to the Continent—Belgium (3), France (13), and N. Spain (1)—and one of a bird recovered in Sweden in its second winter. The oldest bird was eleven years of age.

In addition, there are a few records of birds of unknown origin ringed on migration, both as juveniles and as adults, and recovered in France within the next few months. Birds native to Norway, Holland and Silesia have been recovered in the British Isles in their first or second winters. One ringed in Belgium in autumn has been recovered in Yorkshire in a subsequent summer.

#### REFERENCE

- THOMSON, A. LANDSBOROUGH (1958): "The migrations of British hawks (Accipitridae) as shown by ringing results". *Brit. Birds*, li: 85-93.

# PHOTOGRAPHIC STUDIES OF SOME LESS FAMILIAR BIRDS

## LXXXVIII. CAPERCAILLIE

Photographed by KURT ELLSTRÖM, ENAR SJÖBERG  
and JONAS SVENSK

(Plates 29-32)

Text by D. G. ANDREW

THE CAPERCAILLIE (*Tetrao urogallus*) is the largest and most spectacular of the Palaearctic game birds. A fully-grown male may weigh around 12 pounds (even up to 14) and is unlikely to be confused with anything else on size alone. The general colouring is dark slate-grey, with browner wings. A red wattle over the eye and a bristling beard combine to give the bird a very aggressive appearance when seen at close quarters. The female is much smaller and weighs only around 6 pounds. In her plumage of rufous and grey, which merges perfectly with the undergrowth of the pine forests where she nests, the female Capercaillie can be easily confused with the female Black Grouse (*Lyrurus tetrix*), but the latter always shows a fairly conspicuous white wing-bar, and in both sexes of the Black Grouse the tail is more or less deeply forked, whereas in the Capercaillie it is full and rounded. When seen on the ground, the female Capercaillie also has appreciably whiter under-parts and there is a large chestnut patch on the upper breast.

The distribution of the Capercaillie is closely governed by its exacting habitat requirements. It is at its most abundant in areas of mature coniferous woodland where the trees are well spaced out and where there is a good undergrowth of heather and berry-bearing plants such as blueberry and cowberry. Plantations have little attraction until they are 20 or 30 years old. The diet varies considerably according to the season. During the winter months the Scottish birds feed almost exclusively on the shoots, buds and needles of the Scots pine and larch; later in the season the menu is expanded to cover a wide variety of vegetable matter and almost any seeds, berries and shoots seem to be taken, with braekens shoots forming a very popular item in some areas. In autumn much of the feeding is done in stubble fields. The young birds appear to be largely insectivorous. In some areas the bird's feeding habits have unfortunately brought it into conflict with those responsible for forest conservation, but the evidence available suggests that it is only where Capercaillie are present in some numbers and are feeding on young plantations that any real damage is caused.

The Capercaillie is exclusively a Palaearctic species with a range that stretches from Spain in the west to the Lake Baikal area of Siberia in the east. Within this area its distribution is

governed, as already stated, by the availability of suitable forests. The typical race is found in Scotland; in Scandinavia eastwards through the *taiga* regions of Russia; in the Baltic States; over a large area in Central Europe; and through the Carpathians into the Balkan States. Two other races are now recognised in Russia—*T. u. uralensis* in the forest steppe, the southern Urals and the southern forest regions of western and central Siberia, and *T. u. major* in the south-west of European Russia. A fourth race—*T. u. aquitanicus*—inhabits the Pyrenees and the Cantabrian Mountains in North Spain although it is now considerably reduced in numbers. It is only within comparatively recent times that this last population has become discrete, as Capercaillie were found in the Auvergne Mountains in central France until the end of the 18th century.

The only other representative of the genus is the Siberian Capercaillie (*T. urogalloides* = *parvirostris*), a blacker bird with much white on the wing and a long, graduated tail, which inhabits the eastern half of Siberia (except the extreme north), N. Mongolia, Manchuria, the island of Sakhalin and (a separate race—*T. u. kamtschaticus*) Kamchatka.

The Capercaillie has had a chequered history in Britain. It was at one time to be found in England, Ireland and Scotland, but it disappeared from England in the middle of the 17th century and from Ireland and Scotland in the latter half of the 18th century. Its extermination was principally due to the wholesale destruction of forests that took place in the middle ages. In Scotland the old Caledonian forest had almost completely vanished by the 17th century, and although a considerable amount of replanting was carried out by enlightened land-owners in the 18th century, this change of policy came too late to save the Capercaillie. The date for the extinction of this species in Scotland is usually given as 1760, but there is evidence to suggest that the last two birds were shot in Deeside as late as 1785. Readers with a taste for ornithological detection may be referred to a fascinating article by Sir Hugh Gladstone (*Scot. Nat.*, 1921, pp. 169-177) in which he traces the history of a specimen in the Hancock Museum and concludes that this was probably one of the last birds shot in Scotland. If so, it seems to be the only extant specimen of what may well have been a distinct race.

The first successful reintroduction in Scotland took place in 1837-38, when Lord Breadalbane released 44 birds imported from Sweden, at Taymouth Castle in Perthshire. There were a number of subsequent introductions, with the result that the bird has spread and is now widely distributed over most suitable areas between the Dornoch Firth in the north and the Forth-Clyde valley in the south. A detailed summary of the present status of the Capercaillie has recently been compiled by Dr. Ian Pennie (*Scot. Nat.*, 1950, pp. 65-87 and 157-178; 1951, pp. 4-17).

The name is derived directly from the Gaelic (*capull* = horse,

*coille* = of the wood). The horse element may seem out of place, but it is probably used in a figurative sense meaning "big" (cf. horse-radish and horse-lark, the latter a local name for the Corn Bunting, *Emberiza calandra*). Curiously enough, a similar figurative use appears in the scientific name *urogallus* (*urus* = bull, *gallus* = cock), a parallel in English being found in the name "Bullfinch". Older writers, especially, often spelt the name "Capercaillie". This has all the appeal of the bizarre, but it is entirely spurious. In the old Scottish script the second "l" was represented by a special symbol which indicated the stressed quantity of the double consonant. This symbol resembled the letters "z" and "y" in the modern style of handwriting and came to be misread as such ("Capercaillie" is a spelling one also finds in the older books). In fact neither of these letters exists in Gaelic.

Hybrids resulting from ♂ Black Grouse × ♀ Capercaillie matings are relatively common and there are over 200 published references in the literature. These hybrids appear to be particularly common in areas where the species is expanding, probably due to the fact that the females usually arrive a year or two before the males. Hybrids are, however, not uncommon even in districts where the species is well-established and they were well-known to the old ornithologists who for some time treated them as a separate species—*Tetrao medius*. Back-crosses between the ♂ hybrid and the ♀ Capercaillie are at least sometimes fertile. Such promiscuity between birds of two different genera is most unusual. It is no doubt facilitated by the difference in size between the sexes in both species and also by the fact that both species are naturally promiscuous amongst themselves, in the sense that there is none of the regular pair formation that is normal in most other species—even in such a closely related species as the Red Grouse and Willow Grouse (*Lagopus lagopus*).

There appear to be two phases in the Capercaillie's display. In the early part of the season the males gather at communal display grounds where they parade to and fro but without paying much attention to each other. Later in the season each male takes up its own territory where the display is carried on individually. The song consists of a succession of clicking noises, followed by a sound like a cork being drawn from a bottle and ending (appropriately enough) with a noise like an unevenly operated soda-water syphon. At the same time the wings are clapped loudly.

The accompanying photographs, taken in Central Sweden by Kurt Ellström, Enar Sjöberg and Jonas Svensk, show the attitudes taken up by the male Capercaillie during the display. The head and neck are stretched to their limit with the bill almost vertical, the wings are slightly drooped and the tail is fanned stiffly out and supported by the under tail-coverts (plate 29). During the preliminary notes before the bottle is opened, the throat feathers

are erected to form a thick ruff round the neck, and this is clearly shown in plates 30 and 31 lower. When the climax of the song is reached, the bird closes its eyes and is completely absorbed in its own performance, and the classical method of hunting these birds is to play the old game of "Grandmother's Footsteps" during these brief periods of blindness and deafness. The unusual rear view in plate 32 shows clearly how the very square-tipped tail-feathers fit together to form a perfect semi-circle when fanned out.

The normal display season lasts from early April until late May, but it is very much dependent on the earliness or lateness of the season. As can be seen from these photographs, however, the mere presence of snow on the ground does not inhibit the performance. The main activity takes place in the early morning, starting at or before dawn and not infrequently continuing until midday, with a renewal of activity around sunset. Display has also been recorded in the autumn in the months of September and October.

## NOTES

**Red-breasted Goose in Sussex.**—While watching a flock of 112 White-fronted Geese (*Anser albifrons*) on flood water at Amberley, Sussex, on 8th February 1958, one of us (P.R.M.) had a brief view of a Red-breasted Goose (*Branta ruficollis*) amongst them. The next day we saw it again under excellent conditions, in bright sunlight, at about 300 yards' range. It was a dark goose, smaller than the White-fronts and with a smaller head and neck in proportion to the body. In flight the wings appeared narrower. The head, hind neck, back and lower breast were black, and there was a dark red patch extending down the front of the neck on to the upper breast. The belly and the under tail-coverts were white, and there were white lines between the red and the black areas, the white between the back and the lower breast forming a broad conspicuous band. There were also white markings on the face.

The bird was not present among 52 White-fronts seen in the same area by A.B.W. on 5th February, so very probably arrived with the remainder of the White-fronts between 5th and 8th February. In common with other observers—among them Mr. D. D. Harber—we saw it on several occasions up to and including 15th February 1958. This is the first record for Sussex.

P. R. MILLS and A. B. WATSON

[Enquiries from the Wildfowl Trust and elsewhere show that there is little likelihood that this bird had escaped from captivity in the British Isles, but it is impossible to be certain that it had not come from a wildfowl collection on the Continent. However, past records indicate that wild Red-breasted Geese do occasionally visit this country and, as there is nothing in the description to suggest that this was anything but a wild bird, we consider that it should be treated as such. It therefore constitutes the fifteenth

authenticated record for the British Isles. The twelfth and thirteenth occurrences were published in *British Birds* in 1955 (*antea*, vol. xlviii, pp. 136-137), but the fourteenth record has not previously been referred to in our pages: this was a single Red-breasted Goose seen by Mr. D. Fraser on 20th January 1957, feeding amongst about 100 Grey Lag Geese (*Anser anser*) in a field of winter wheat on the shores of Beaully Firth, Inverness-shire (*Scot. Nat.*, vol. 69, p. 118); it was probable that it had been in or near that area since September 1956.—EDS.]

**Buff-breasted Sandpiper in Lanarkshire.**—On 27th October 1957, near Hamilton, Lanarkshire, I saw a small wader consorting with Dunlin (*Calidris alpina*) and Snipe (*Capella gallinago*), which I subsequently identified as a Buff-breasted Sandpiper (*Tryngites subruficollis*). It was at the muddy verge of a pool where the ground had been trampled by cattle, and I watched it for half-an-hour, first from 80 yards and eventually down to about 40 yards' range.

About the size of a Snipe, it was hunched and plump-looking, uniform pinkish-buff on face, throat, breast and belly. Its head was small and rounded, and the bill slender, black and tapered. (With the head in certain positions I found this taper gave the bill a distinct, if erroneous, appearance of being decurved.) The eye was dark and there was no eye-stripe. Mantle and back had a "scaly" pattern very like that of a Reeve (*Philomachus pugnax*), with dark-centred feathers edged pinkish-buff. The crown was dark; I did not see the leg colour.

When feeding, the bird maintained its crouching, hunched position, with legs bent. It was obliging enough once to stretch its wings up, showing much white on the underwing, broken by darker markings towards the tip. Mainly, however, it was not inclined to activity, and stood for a long period practically immobile. Eventually it squatted on the ground beside two Snipe. I then went forward and put it up to check on the wing pattern—but, beyond confirming that it lacked the white tail-patches of a Reeve, I failed to note anything distinctive before the bird swung away in strong flight, gaining height and presenting only an end-on view, rapidly receding. It uttered no sound during the period I had it under observation; and it was not seen in particularly good light, the day being dull and stormy.

On 28th October Prof. M. F. M. Meiklejohn saw the bird and confirmed the identification. In addition to the main diagnostic points given above, he was able to see the legs in good light, and they were yellow. He made out the paler elliptical mark on the upper surface of the wing, but it was "not at all a noticeable feature", and he only discerned it on flushing the bird for the third time, when he was especially looking for it. The rump he noted as black. When the bird was feeding, he described it as progressing "with a sort of stealthy walk".

On 29th October Mr. W. Kenneth Richmond observed the bird "in poorish light and only briefly, but well enough to be satisfied with the correctness of the identification". He found it in the company of a Dunlin, compared with which it was slightly bigger, "noticeably upright in carriage, round-headed" and, to his eye, "rather dotterel-like". In flight he marked the rump as "non-descript, and all of a piece with the rest of the upper-parts".

One or two other observers had glimpses of the bird, but it was not seen again after 30th October (31st October and 1st November were stormy). Most of those who saw it were surprised at the bird's shyness, since it is described in *The Handbook* as being "usually extremely tame". This is the first record of the Buff-breasted Sandpiper for Scotland.

L. A. URQUHART

**Broad-billed Sandpiper in Hampshire.**—On 12th October 1957, by the lagoon at Farlington Marshes, Hampshire, we found a small wader which we later identified as an adult Broad-billed Sandpiper (*Limicola falcinellus*) in transitional plumage. The following day, 13th October, the bird was seen by Messrs. A. Allen, R. H. Dennis, G. Kinsey, B. W. Renyard, G. H. Rees, A. Searle and S. White. The following detailed description was made.

*Head*: crown densely streaked dark brown or blackish; a conspicuous creamy stripe over the eye and, in addition, an inconspicuous, short, pale stripe passed backwards from the base of the bill, above the supercilium and separated from it by dark feathering (this secondary pair of crown stripes was difficult to see from the side, but clear enough from a head-on view); back of head and nape lighter and slightly greyer than mantle or crown; ear-coverts dark. *Back and wings*: boldly patterned, similar to Jack Snipe (*Lymnocyptes minimus*) or Pectoral Sandpiper (*Calidris melanotos*), both of which species were present that week-end; centre of back very dark, with a pair of conspicuous cream stripes from shoulders to upper-parts of rump; another lower and broader "V" was formed by pale edgings to scapulars; feathers of folded wing edged buff-brown, *secondaries with bright chestnut* (in sunlight this was a predominant feature of the bird); carpal joint showed as a dark patch; centre of rump and tail blackish, lateral tail-coverts white, outer tail-feathers pale greyish. *Under-parts*: chin and upper breast pale buff (chin paler, but not pure white); streaking on sides of breast, which just met in a narrow band across the centre; belly and vent silvery white. *Bill*: relatively long and heavy, stout at base and decurved at tip rather like that of a Ruff (*Philomachus pugnax*); colour of bill dark brown, base paler. *Legs*: colour varied with light, but was generally agreed to be olive.

It was in general squat and short-necked, appearing about the size of a Little Stint (*Calidris minuta*) but relatively longer-bodied (possibly an illusion due to the low carriage). It showed a preference for reed and spartina stubble, where it moved with a crouching gait and was difficult to find or flush, having a strong tendency to walk away and hide out of sight. In flight the bird appeared very dark-backed and occasionally uttered a quiet "chree" or "chree-chree".

D. F. BILLET and C. J. HENTY

[We showed this record to Mr. P. W. P. Browne, in view of



his particular experience of Broad-billed Sandpipers out of breeding plumage (*antea*, vol. xlviii, pp. 375-376), and he commented as follows: "I presume the bird was thought to be an adult because the chin was not white. However, this is not a feature which could be relied upon (from the point of view of field-observation) and I should be surprised if an adult still had a bright chestnut patch on the secondaries by 12th October; a juvenile would be less likely to have the chestnut edges worn off".—EDS.]

**Broad-billed Sandpiper in Berkshire.**—On the evening of 19th September 1956, at Ham Island sewage-farm, Old Windsor, Berkshire, we found a small wader having the general conformation of a Dunlin (*Calidris alpina*) but with markedly different plumage. It was feeding on wet mud, picking from the surface, and allowed very close approach. No other waders were present for direct comparison, but its size appeared to be between that of a Little Stint (*C. minuta*) and a Dunlin. The following details were noted:

The crown was dark, with faint light streaking. The side of the head was a warm brown with a dark line extending from just behind the bill through the eye, and a broad whitish superciliary stripe; this stripe was not very clearly defined, but widened behind the eye where an indistinct wedge of rufous-brown divided it into two. The stout, dark bill was longer than the head and slightly, but quite noticeably, decurved towards the tip. The upper-parts were deep rufous-brown, with conspicuous light edges to the feathers. A feature which at once attracted attention was a double, pale, creamy-buff line on either side of the back; these formed two incomplete "V"s, the inner one being well defined. The sides of the breast were streaked with brown, but the rest of the under-parts were white. The legs were black and short. When flushed, it flew low to another irrigation bed and showed, on rising, a dark centre to the tail, the outer feathers appearing white. Only a faint suggestion of a light wing-bar was seen and against a dark background the bird was very inconspicuous in flight. Its call was noted as "st, st, st" (D.C.) or a thin "trii, trii, trii" (C.M.V.), unequally spaced and repeated some five to seven times.

From the features observed we identified the bird as a Broad-billed Sandpiper (*Limicola falcinellus*) and this was confirmed by subsequent examination of a number of skins at the British Museum (Natural History). This is the first record for Berkshire.

DOUGLAS CARR and C. M. VEYSEY

**Black-throated Thrush at Fair Isle.**—An adult male Black-throated Thrush (*Turdus ruficollis atrogularis*) was persuaded to enter the Double Dyke trap at Vatstrass, Fair Isle, at 13.25 hours G.M.T. on 8th December 1957. It was later released at the observatory, and was usually to be found in the vicinity of the buildings until the 16th. It was photographed in the hand by my wife (see plate 33), and was watched at various times by G. Stout of Field, J. Stout of Midway, and Alan Till. My wife and I left Fair Isle on 20th December, and we later learnt that the bird reappeared in the area of the observatory buildings soon after that date. It was seen there regularly, by the Stouts and

others, until about 22nd January 1958 (the middle of a week of severe weather with much snow).

The male of this species is one of the easiest of birds to identify, and it is probably unnecessary to reproduce the detailed laboratory description, which is virtually a paraphrase of that given in *The Handbook*. In the field, the enormous black bib, contrasting sharply with the whitish lower breast and belly, can be clearly seen at a distance of a hundred yards or more in moderate light. The dark area extends to the lores, supercilium and sides of the neck, the ear-coverts being a similar grey-brown to the rest of the upperparts, the crown rather darker and with black markings in the centre of most feathers. The tail has grey-brown central feathers, and dark, almost black, outer ones. In the Fair Isle bird the black feathers of the head and bib were mostly tipped narrowly with grey, but these tips were hardly noticeable in the field, except that they gave a slightly ragged effect to the edges of the bib. The bill was dark brown except for the basal two-thirds of the lower mandible, a striking orange-yellow.

In size and shape this thrush is very like a Fieldfare (*T. pilaris*) appearing to have a proportionately longer tail than some of the other thrushes. Most of the time it was under observation, our bird was engaged in exploring the short turf of the sheep-grazings, in exactly the manner of a Blackbird (*T. merula*). Worms are scarce in the Fair Isle pasture, and none of the food located was large enough to be seen by an observer, but during complete snow-cover on 9th and 10th December the thrush was glad enough to visit piles of meaty and fatty scraps we had placed around the area.

When approached, this bird would stop, raise its head, and stare intently, often for some minutes if the watcher did not come nearer than fifteen yards. Occasionally it would fly on to a wall, if one were close, to take a better view. The usual method of retreat was by running, and it would only fly when hard pressed or too restricted by obstacles. The tail was often cocked on landing. No call was heard at any time.

Although thrushes of four other species were present, the Black-throat never consorted with them, except at the time of first capture when it was closely accompanied by two Redwings (*T. musicus*).

The measurements of the Fair Isle bird were all at the upper limit of the range given in *The Handbook*: wing (straight) 143 mm., (chord) 140 mm., tail 105 mm., bill 22 mm., tarsus 36 mm. The weight at first capture (13.25 hours on 8th December) was 89.6 gm., which is light for a bird of Fieldfare size, but this had improved to 95.0 at recapture at 14.15 G.M.T. on the 14th. The flight-feathers were little abraded. There were none of the pale tips to the greater coverts which are said to characterize the first-winter bird.

The record is the first for Fair Isle and *The Handbook* gives

four others for Britain. Rather curiously, all the occurrences have been in mid-winter. The key to possible explanation of this is given in *The Handbook's* statement that some individuals remain in the breeding area in central Russia when the majority move south to winter in India. It may be that such individuals would be particularly prone to long-distance hard-weather movements, and this 1957 record is known to have been preceded by hard weather over much of Europe. It may also be that adult males would be more sedentary than females or young, and four of the British birds are known to have been males; but this should not be overstressed, since the female is a far less conspicuous bird.

PETER DAVIS

**Pallas's Warbler in Norfolk.**—On a field expedition of the Cambridge Bird Club on 17th November 1957, a small Passerine was flushed from an elder bush in the dunes at Gore Point, near Holme, Norfolk, by J. S. Clark. The bird resembled a Goldcrest (*Regulus regulus*), but was seen to have a yellow rump. It flew into a patch of sea buckthorn, where J.S.C. drew the attention of others to it. The bird was then watched for half-an-hour by J.S.C., G. M. S. Easy, D. Farren, R. Genochio and C. H. Hagger, at a range of about five yards, and the following field-characters were particularly noted: (1) very small size, about that of Goldcrest; (2) primrose yellow rump; (3) pale yellow crown stripe; (4) yellow superciliary stripe above a very dark stripe running through the eye; and (5) two pale wing-bars. The bird was extremely active and spent most of its time low in the bushes, searching for insects. It sometimes hovered while feeding, like a Goldcrest, and the yellow rump was then very conspicuous. Occasionally it would make a short vertical flight from the bushes to snap up an insect, rather like a flycatcher (*Muscicapa* sp.). It seemed clear that it was a Pallas's Warbler (*Phylloscopus proregulus*).

The bird was then caught in a mist net, and ringed by P. R. Evans. Whilst in the hand it was photographed by J. L. Cutbill (see plate 36), and the following description and measurements were taken:

*Head:* crown dark olive-green, with central stripe of pale yellow; prominent pale yellow superciliary, and very dark stripe through eye; cheek and throat pale yellow, merging to greyish-white under-parts. *Mantle:* bright olive-green. *Rump:* bright primrose yellow, very conspicuous. *Tail:* dark olive-green, square-ended; under tail-coverts pale yellow. *Wings:* olive-green with two pale yellow wing-bars; the anterior bar (formed by the tips of the median coverts) was narrower and less conspicuous than the posterior one (formed by the tips of the greater coverts); the edges of both primaries and secondaries were tinged yellow. *Bill:* rather heavy for the size of the bird; brown, with lower mandible paler at the base. *Legs:* dark sepia brown. *Measurements:* wing 50 mm., bill (from skull) 10.5 mm., tail 40 mm.

The bird was seen by about 30 members of the Club between 3.15 and 4 p.m., just before the party left to return to Cambridge. This is the second record for Norfolk and the third for the British Isles.

CAMBRIDGE BIRD CLUB

**Thrush Nightingale at Fair Isle.**—A Thrush Nightingale (*Luscinia luscinia*) was trapped in the gully at Fair Isle on the afternoon of 10th May 1957. It was examined in the laboratory by Peter Hope Jones and myself, and was later shown to George Stout of Field and James Stout of Midway, who chanced to be working near-by.

From *The Handbook's* description, it seemed that the most certain way of distinguishing this bird from the very similar Nightingale (*L. megarhynchos*) lay in the short first and long second primaries of the present species. In the captive bird the first was 8 mm. shorter than the primary-coverts and the second only 4.5 mm. shorter than the third or longest primary; only the third primary was emarginate. The measurements taken included: wing (straight) 86 mm., (chord) 83.5 mm., tail 63 mm., bill 13.5 mm., tarsus 27 mm. At a weight of 21.6 gm. our bird seemed light for its size, and this suggests a protracted North Sea crossing in the gentle south-east breeze prevailing at the time.

The plumage of the upper-parts and wings was a uniform earth-brown, rather rufous on the upper tail-coverts and at the outer edges of the primaries. The tail was a rich warm rufous-brown. The chin and throat were whitish in the centre, with a dark earth-brown wash at the sides. The breast and flanks were greyish earth-brown, paler than the mantle, and most feathers had darker centres, with a few warm buff webs about halfway down: this gave a general effect of indistinct vertical striations. The centre of the belly was whitish, the under tail-coverts were warm buff with slight dark barring. The upper mandible of the bill was dark horn, the lower mandible paler with a pinkish tinge. The legs and feet were pinkish-brown, with a purple tinge on the leading edge of the tarsus. The tail was heavily abraded, the primaries not noticeably so. It was decided, from the presence of small paler tips on the outer greater coverts and two or three inner secondaries, that the bird was in its first summer.

This is the third British record for the species, and the second from Fair Isle. Since it breeds as close to Britain as Denmark and southern Scandinavia, it is perhaps surprising that the records are so few, and a very careful examination of any Nightingales caught at the Bird Observatories might well be rewarding. The 1957 bird gave us no opportunities for field observation, but under normal conditions it must be very seldom that the striated breast can be seen, for the members of the genus are notable skulkers. It is perhaps worthwhile, however, to quote that very careful observer, the late Duchess of Bedford, who was present at the shooting of the first Fair Isle specimen in May 1911. She wrote in her diary: "Wilson shot what Mr. Eagle Clarke says is a Nightingale. It does not seem to me nearly russet enough for our common one". The greyer shade of the mantle may therefore be of some value to observers with adequate experience of the commoner bird.

PETER DAVIS

**Serin at Fair Isle.**—A period of easterly winds in the fourth week of May 1957 brought a wide variety of Continental species to Fair Isle. The movement was heralded by the appearance of a very handsome adult male Rustic Bunting (*Emberiza rustica*) on the 22nd (see below), and confirmed by the arrival of an old male Woodchat Shrike (*Lanius senator*) and a sprinkling of small night-migrants, as the wind moved south of east on the 23rd. The peak day was the 24th, with fair numbers of the commoner chats, warblers and flycatchers, also two Bluethroats (*Cyanosylvia svecica*) and three Red-backed Shrikes (*Lanius cristatus collurio*). The outstanding bird of the movement was a male Serin (*Serinus canarius*), seen on the 25th, when many of the previous day's migrants had moved on.

I was cycling along the road fronting South Harbour, in the late morning of this calm and sunny day, when a rapid jingling and trilling song drew my attention to a small bird on the telephone wires a hundred yards ahead. The yellow breast, visible through binoculars, made me suspect at first that it was a Siskin (*Carduelis spinus*). Concealment was impossible, and the bird was rather uncooperative, moving along the line of wires about fifty yards before me as I advanced, but eventually I had a clear view from about thirty yards' distance. I noted at once two rather indistinct yellowish wing-bars, instead of the one prominent one which is a feature of the Siskin, and also a yellowish forehead, distinct yellow supercilium, and dark green crown and ear-coverts. The bird then flew down from the wires to disappear behind a stone wall, and as it did so I could see that there were no yellow patches at the sides of the tail, the rump alone being bright yellow. Apart from this and the wing-bars, the entire upper-parts, wings and tail were dark green at this distance. I failed to find the bird again, although a prolonged search was made later in the day.

There is one previous record of the Serin at Fair Isle (a female shot in May 1914) and one other from the mainland of Scotland.

PETER DAVIS

**Rustic Bunting at Fair Isle.**—A very fine adult male Rustic Bunting (*Emberiza rustica*) was captured by Peter Hope Jones in the gully trap at Fair Isle in the late afternoon of 22nd May 1957, and brought to me. It was examined and ringed in the laboratory, and photographed in colour.

The spring moult of the head and throat was almost complete, the black areas having only a few old feathers with pale tips, and the white parts being pure. Very few of the chestnut feathers of the nape, breast-band and rump retained the buff-white tips of the winter plumage. Apart from these, the bird was in perfect "picture-book" plumage. The flight-feathers were all in good condition, showing wear only in the central tail-feathers. The bill had a grey-horn upper mandible; the tip of the lower mandible

was of the same shade, but its base was pinkish-horn. The legs were pale pinkish-brown, the eye very dark brown.

Measurements taken included: wing (straight) 79.5 mm., bill 12.5 mm., tarsus 18 mm., tail 58.5 mm. The weight was 20.45 gm. at 17.00 hours G.M.T. Two fleas were removed, and these have been determined by F. G. A. M. Smit as male *Dasypsyllus g. gallinulae*.

There are nine previous records of Rustic Buntings at Fair Isle, the last being in 1946. PETER DAVIS

## REVIEW

PORTRAIT OF A WILDERNESS. By GUY MOUNTFORT. Illustrated by ERIC HOSKING. (*Hutchinson*, London, 1958). 240 pages; 60 plates incorporating 130 photographs in monochrome and colour; line-drawings. 30s.

ONE OF THE SYMPTOMS of the modern "ornithomania" to which Mr. Mountfort refers in his preface has been the tendency of British bird-watchers to pursue birds abroad. Overcrowded in our own island, we are not far from being overcrowded at home as ornithologists. Consequently, the British list is being interpreted more and more as European, which in fact it is. Thus, foreign fields are more and more visited as readily as our own bird resorts.

With this development it is remarkable how little, comparatively, anyone has visited the bird-paradise of Andalusia, despite the fact that with it are associated such famous old names as Lord Lilford, Howard Saunders, Irby, Jourdain and Witherby. It is the more remarkable because of all Europe no region has had for so long such exciting, early accounts of the wealth of its wild life. Abel Chapman's *Wild Spain* and Verner's *My Life among the Wild Birds in Spain* ought long ago to have inspired a close study of so rich an area. Perhaps today, when all the emphasis is on detailed study in the back garden, such books for the young are put under an interdict. It is true that they are the works of a hunter and of an egg-collector respectively, but with modern enlightenment they are not difficult to interpret in their correct historical and ethical perspective. *Autres temps, autres moeurs*.

Those who have been privileged to visit the Coto Doñana, and those who never had Abel Chapman served up to them in youth, will be alike delighted to read Mr. Mountfort's book, especially as the recent papers in *British Birds* will have prepared them for what to expect. If there was any spot in Europe which obviously would repay close study, it was this corner of Spain. How well rewarded Mr. Mountfort has been, even the most cursory look through these pages will immediately reveal. First glances could well leave the reader to think that he was reading the *Field Guide* in narrative form! In these days, when the rarity is rather under a cloud and its pursuit frowned upon by the high table of

ornithology, it is good to find one who so unashamedly as the author sets forth with joy in pursuit. How good, too, to see that half of the distinguished editorial board of this journal find themselves caught in Mr. Mountfort's attractive snare!

The wealth of the Coto, described and illustrated in this book, is too great for a brief review to do more than indicate. The author gives a short historical background, ornithological and social; in three chapters outlines the journeys and personnel of his three expeditions; and then proceeds to deal with the abundant wild life, not forgetting the mammals, insects and flowers, by habitats or groups of species. There are chapters devoted more specifically to such star performers as the Imperial Eagle and the kites. In the midst of this almost embarrassing wealth of material the sheer beauty and peace of the Coto are not forgotten, and the chapter entitled "A Day at Martinazo" will bring both joy and nostalgia to all who have known such wildernesses. Finally, Mr. E. M. Nicholson contributes an excellent chapter on the ecology of the Coto.

With so many great names in ornithology present on the expeditions, factual errors are not to be expected. However, the oft-cited mistake of quoting Abel Chapman as the original describer of the incubating posture of the Flamingo is here again repeated. (It was, in fact, Sir Harry Johnston—on the Lake of Tunis.) And if Mr. Mountfort is correct in claiming it to be unique in Europe to see four species of eagle in one day in the Coto, then his own *Field Guide* would appear to need revision, for it should be possible to see at least five in Roumania—always supposing one could get there!

With so much ground to cover it is inevitable that there should be some omissions. Despite all the scientific purpose of his expeditions, the author decided in his planning that the glories of the Coto could best be brought home to the British ornithologist not merely by esoteric papers in learned journals but also with the aid of photography. In view of the big part this aspect plays in his book he could well have improved the historical perspective in his introduction (or in his bibliography) by the mention of the Coto's pioneer photographers—of the work of W. Farren, published in the long-defunct *Wild Life*, of Bentley Beetham's *Amongst Our Banished Birds*, and of R. B. Lodge's *Bird Hunting through Wild Europe*. Mr. Mountfort also seems very preoccupied with "firsts", i.e. the first time a species has been photographed. Quite apart from the fact that such a point is of small consequence (for what really matters is the technical excellence and interest of a series), the claims in some cases are hasty or at least require qualification. He implies (p. 132) that the expedition's photographs of the Short-toed Eagle were the first. This entirely overlooks the work (still and film) done in the Cevennes on this species by Y. Boudoint. He is so keen on these "firsts" that he is prepared to claim them just for colour work alone. If his expedition was

the first to photograph Squacco Heron in colour (p. 100), it could only have been by hours or days before Helmut Drechsler in the Camargue in 1956. Even in the case of the Imperial Eagle, the qualification that a photograph, however poor by modern standards, had been taken by R. B. Lodge as long ago as 1907, albeit of the Roumanian race, would have been a courteous gesture to an enterprising pioneer of bird photography, working under very difficult conditions of equipment.

The illustrations are superb. It is only necessary to say that even Mr. Eric Hosking has never exceeded this standard. It is true that the constant light of the Coto helps colour photography, but all who have used a camera in the south know how devastating the effect of blazing sun can be on monochrome. Mr. Hosking has handled this technical problem with great skill. To select any out of such a galaxy for special merit would be invidious, but particular mention must be made of those of the Short-toed Eagle. This, however, is merely a personal choice, for from the humble Savi's Warbler to the great Imperial Eagle all are in that class of perfection in which British bird photographers lead the world.

The final picture which emerges from this book is that here in the Coto Doñana is a bird paradise, an unspoilt sanctuary which has so far miraculously escaped man's all-devouring advance into the wilderness, partly because of the physical problems it sets, but largely thanks to the enlightened family who administer it. At all costs it *must* be preserved. This review, therefore, like the book, must end on a note of warning. Because today so many want to see birds, strict control of precious sanctuaries is essential. It is all too easy for an author, with such a subject to describe, to play the Pied Piper. The Coto is one such place, and Mr. Mountfort rightly emphasises that it is private property, and points out that most of its birds, if not so concentrated, can be seen in other parts of Andalusia (some actual localities were given in *British Birds* for December 1957, *antea*, vol. L, pp. 502-504). It is to be hoped that his wishes and the privacy of the González family will be respected. It would be small reward to Mr. Mountfort for giving us this absorbing book if it proved otherwise. G.K.Y.

## REQUESTS FOR INFORMATION

### FIELD INVESTIGATIONS OF THE BRITISH TRUST FOR ORNITHOLOGY

**Status of the Wryneck.**—Readers are reminded that all records of this species are of value (see *antea*, p. 163) and should be sent to editors of county bird reports or, in cases of doubt, to the organizer: Dr. J. F. Monk, Little Stow, Goring, near Reading.

**Survey of Black-headed Gulls.**—Helpers are still required to visit and estimate the size of breeding colonies, especially in Scotland and Wales (see



*antea*, p. 164). Please write for record cards to: F. C. Gribble, 42, The Grove, Bedford (England and Wales); F. D. Hamilton, 4, Bruntsfield Terrace, Edinburgh 10 (Scotland).

**Status of the Nightjar.**—For the second year a survey is being organized by Dr. J. Stafford, Stone House, Shoreham-by-Sea, Sussex. Anyone able to provide information on the Nightjar this summer (including negative reports from previously frequented habitats) is invited to get in touch with him.

**Habitats of the Oystercatcher.**—An enquiry is being organized by E. J. M. Buxton, New College, Oxford, into the spread of the Oystercatcher inland in England and Scotland. Since the 18th century these birds have bred up the river valleys of eastern Scotland, but they do not seem to have spread inland in England until the present century and they are now also to be found nesting on farmland and moorland away from the rivers. The purpose of the enquiry is to trace the history and extent of this spread.

## RECENT REPORTS AND NEWS

By I. J. FERGUSON-LEES

**The items here are largely unchecked reports, and must not be regarded as authenticated records. They are selected, on the present writer's judgment alone, from sources generally found to be reliable. Observers' names are usually omitted in case a report is subsequently rejected, and none of the items will be mentioned in our annual Index. Readers are asked to submit anything of interest as quickly as possible.**

This summary is chiefly concerned with the period 22nd March-1st May, a time which normally sees the arrival of the majority of the summer visitors and the departure of all but the last of the winter ones. This year the cold spell—which began in early March and, with only one short break at the end of that month, continued until 18th April—delayed things to such an extent that the main rush of summer migrants did not take place until the night of 19th/20th April and the two successive ones, and there were still many Fieldfares (*Turdus pilaris*) and Redwings (*T. musicus*) in large flocks in the middle of the month. The prolonged easterly and south-easterly winds that were an unusual feature of so much of March and April contributed enormously to the interesting pattern that has emerged.

A south-easterly gale, with bitterly cold conditions, brought a rush of migrants, especially Turdidae, to Great Saltee (Co. Wexford) in the fourth week of March: Blackbirds (*T. merula*) and Bramblings (*Fringilla montifringilla*) were in large numbers, but very weak and much below normal weight; some Wheatears (*Oenanthe oenanthe*) died in the hand, though Chiffchaffs (*Phylloscopus collybita*) were lively enough; more Song Thrushes (*T. philomelos*) appeared there than in any previous spring. Chiffchaffs reached Skokholm on 25th March; subsequently more were trapped there than in the whole of any previous year. (Northwards dispersal was slow, however, and Chiffchaffs did not reach Rhum, in the Inner Hebrides, until the last week of April.) These were part of the otherwise moderate arrival of summer visitors which, as mentioned last month (*antea*, p. 164), occurred during the short spell of milder weather at the end of March; at the same time there was a much more spectacular movement of certain other species.

In the south, from Kent to Dorset and even to the Scilly Isles (St. Agnes Bird Observatory) and Skokholm in the west, the Robin (*Erithacus rubecula*) was widely reported as the most notable bird of this end-March movement. At Dungeness, Kent, 3 were ringed on 25th March and in the early hours of the following morning there were large numbers round the lighthouse, after which an estimated 500 were to be seen in the Observatory area and 120 were ringed on that day; the next morning, 27th March, there were fewer at the light and only about 350 afterwards in the Observatory area, but the fact that 101

were ringed then and that these included no retraps from the 26th suggests that they were almost entirely new arrivals; in all, during the six days 25th-30th March, no less than 262 Robins were ringed at Dungeness. The majority of those handled were of the pale Continental form (*E. r. rubecula*) and many observers along the south coast reported the presence of unusual numbers of "greyish and pale orange" Robins at this time. The Robin movement was also reflected up the east coast in many areas, and at Monks' House in Northumberland about 30 Continental Robins were trapped in two periods, 28th-31st March and 11th-12th April. On the east coast, however, Blackbirds and Song Thrushes, and also Goldcrests (*Regulus regulus*), were equally or more conspicuous species, and at Monks' House the spring passage of these birds was the heaviest on record. At Fair Isle and S. Shetland, during 29th March-1st April, this movement took the form of what is described as "the biggest spring rush ever seen", with Blackbirds "in thousands" and Lapwings (*Vanellus vanellus*), Song Thrushes, Robins again, Skylarks (*Alauda arvensis*), Chaffinches (*Fringilla coelebs*) and Starlings (*Sturnus vulgaris*) "in hundreds": over 500 birds were ringed there in five days, including 253 (197 Blackbirds) on 31st March. A severe south-east gale occurred at this time, and Mistle Thrushes (*T. viscivorus*)—rare on Fair Isle—and Dunnocks (*Prunella modularis*) were also involved; the Chaffinches were all thought to be the Central European *hortensis*. Just as the Robin movement was reflected in the east and north, so were the Blackbirds in the south, and at Dungeness the numbers were described as "high", with a peak of 150 on 25th and 26th March, dropping to 50 by the end of the month.

As always, this movement of common species included abnormal numbers of one or two regular but less common birds, and a few rarities. Firecrests (*Regulus ignicapillus*), which are regular in spring in very small numbers in south-east England, were both more numerous and more widespread than usual. Dungeness had a maximum of 10, on 27th and 28th March, and in the period 26th March-23rd April no less than 23 were ringed there. At this time, too, there were observations of 1-5 Firecrests in various places in Sussex and Hampshire, and there were 12 or more at Portland, Dorset, on 27th March (with smaller numbers on the days that followed). In addition one was reported from Brent Reservoir, Middlesex, on 9th April, and by the week-end of the 19th-20th single birds were caught at Spurn, Yorkshire, and Bardsey Island, off Caernarvonshire (where there was also a movement of Goldcrests at the time). One was seen at High Halstow, Kent, on 22nd April, and soon afterwards one at Havergate, Suffolk; a total of 13 reports came from Essex during the 6-week period from end-March to 4th May. The Herefordshire Firecrest (*antea*, pp. 132 and 164) was last seen on 5th April. Another more numerous migrant in late March and early April was the Black Redstart (*Phoenicurus ochruros*): reports of single birds in unusual places, or of greater numbers, came from Aberdeen, Fife, East Lothian, Northumberland, Durham, Yorkshire, Lincolnshire, Norfolk, Suffolk, Essex, Kent, Sussex, Hampshire, Dorset, Scilly Isles, Surrey, Bedfordshire, Cambridgeshire, Leicestershire, Nottinghamshire, Cheshire, Skokholm and Bardsey. A female ringed on St. Agnes, Scilly Isles, on 26th March was trapped at Dungeness on 19th April. Hoopoes (*Upupa epops*) were reported, as in every late March and April, from south coast counties from Kent to the Scillies (St. Agnes), but the numbers may have been higher than usual: Portland had a total of about 16 on some 10 days in mid-April, most of them moving quickly inland. One was seen in Essex on 3rd May, and one in Cheshire during 25th-28th April; one of two seen at Skokholm stayed for six days.

Among the more unexpected of the not uncommon species on the move at this time were Woodlarks (*Lullula arborea*) and Cirl Buntings (*Emberiza cirrus*): up to 5 of the former were seen at Dungeness at the end of March, and up to 7 at Portland, Dorset (the first spring records at the Observatory there), while one appeared at Fair Isle on 31st March. It was Portland also that had the Cirl Buntings, a total of 6 (two single females, a pair, and two males). Incidentally, the two commonest buntings, Reed Bunting (*E. schoeniclus*) and Yellowhammer (*E. citrinella*), were both involved in significant

inland movements throughout March, as were Meadow Pipits (*Anthus pratensis*): details are not sufficient for it to be possible to draw any conclusions, but the passage of Reed Buntings in particular was remarked upon in several counties from Middlesex and Essex to Staffordshire and up to Midlothian in Scotland. At Hayes, Middlesex, where the movement took place in two periods, 2nd-12th and 17th-25th March, it was estimated that at least 250 Reed Buntings and 100 Yellowhammers passed through one small area; all actually seen travelling were moving N. or N.N.E.

Of rarer birds reported in the end-March rush, the most interesting were undoubtedly the Bluethroats (*Cyanosylvia svecica*). As one would expect from the geographical distribution of the two west European forms it is the Red-spotted Bluethroat (*C. s. svecica*) which is the regular autumn drift-migrant, while the more southerly White-spotted (*C. s. cyanecula*) is perhaps most likely in spring as a result of over-shooting its range. This year Bluethroats have been reported from seven counties and the following were identified as White-spotted: St. Agnes, Scilly Isles (male, 22nd-24th March); Colne Point, Essex (male, 28th March); Bamburgh, Northumberland (male, 30th March); Pett, Sussex (two males, with an "immature", 1st-13th April); and Spurn, Yorkshire (male, 6th April); those at Spurn and Bamburgh were trapped. In addition, a male Bluethroat in not quite full plumage was seen at Southsea, Hampshire, on 26th March; and there were two at Dungeness, Kent, on 1st April; one of the latter trapped was a male in moult, but the race could not be determined. Other rarities during this period included single Little Buntings (*Emberiza pusilla*) on St. Agnes, Scilly Isles, on 27th March and on Fair Isle on 4th April, while a Short-toed Lark (*Calandrella cinerea*) was reported from Hilbre, Cheshire.

To turn to the summer visitors, this late March/early April movement produced small numbers of Garganey (*Anas querquedula*), Little Ringed Plovers (*Charadrius dubius*), Common Sandpipers (*Tringa hypoleucos*), various terns (*Sterna* spp.), Wrynecks (*Jynx torquilla*), Hirundines, Ring Ouzels (*Turdus torquatus*), Wheatears (*Oenanthe oenanthe*), Willow Warblers (*Phylloscopus trochilus*), Chiffchaffs (*Ph. collybita*) and Yellow Wagtails (*Motacilla flava*). Sandwich Terns (*Sterna sandvicensis*) began to arrive on 26th-27th March (so that, for example, the number at Havergate, Suffolk, had already built up to 20 by the good date of 29th March. Ring Ouzels first appeared at Bardsey Island, Caernarvonshire, on 25th March (with a peak on 1st April) and at Fair Isle, with the first Wheatears, on the 30th, by which time Garganey were reported as far north as Warwickshire. Several House Martins (*Delichon urbica*)—for example, one at Salisbury, Wiltshire, on 26th March, and one at Godstow, Oxford, on the 27th—were surprising arrivals with the other two species of Hirundines (2 or more weeks early). Other early reports at this time included a Hobby (*Falco subbuteo*) at Chew, Somerset, on 7th April, and what was almost certainly another near Salhouse, Norfolk, on the same day (2 weeks early); a Sedge Warbler (*Acrocephalus schoenobaenus*) at Chichester, Sussex, on 30th March (1-2 weeks early), a Reed Warbler (*Acrocephalus scirpaceus*) at Fleet Pond, Hampshire, on 10th April (1-2 weeks early); single Tree Pipits (*Anthus trivialis*) near Millbrook, Southampton, and Portland, Dorset, on 30th March (1 week early) and as far north as Warwickshire on 1st April. The first Blackcaps (*Sylvia atricapilla*) were reported from Bardsey and Portland on 25th and 29th March respectively (the former the only record there up to the middle of April); Redstarts (*Phoenicurus phoenicurus*) appeared at Portland on 30th March, in the City of London on 1st-2nd April, at Durlston Head, Dorset, on 2nd April, as far north as Bartley Green, near Birmingham, by 6th April, and at Chew, Somerset, on 7th April; all except the one at Durlston Head were single males. Whimbrels (*Numenius phaeopus*) arrived in Hampshire at the very beginning of April, the first near Southampton on 30th March.

(Incidentally, while on the subject of early summer-visitors, I made an error in the locality of the early Chiffchaff in song, referred to in our April number (*antea*, p. 164): this was not in Surrey at all, but at Hayes, Middlesex. Other much earlier reports of this kind, that have been received since then, include a Chiffchaff picked up dying in Essex on 25th January; a Wheatear at Rainham,

Kent, on 15th February; a Swallow (*Hirundo rustica*) and a House Martin at Marazion Marsh, Cornwall, on 25th February (there have been five other February records of House Martins in Cornwall in the last ten years, and two early March ones); and two Common Sandpipers (*Tringa hypoleucos*) at Cley, Norfolk, on 9th March.)

This then was the situation brought about by the warm spell at the end of March, but then the cold returned, to an abnormal extent, and the not very large numbers of summer-visitors that had arrived seemed to disappear: about 14th April the report from nearly everywhere was "Very few migrants". Instead, winter visitors like Redwings and Fieldfares, and also Bramblings, were still numerous. Although the two winter thrushes often do not leave this country until well into April and the Fieldfare often into May, it is not usual to see flocks of 200-500 of these two species in the middle of April, particularly in southern England—yet such gatherings were evidently widespread this year and even in Cornwall small parties of Redwings were being recorded up to 16th and 18th April. On the night of 17th/18th a big movement of Redwings and Starlings occurred at Dungeness and a total of 268 of these two species were ringed at the lighthouse. A big passage of Iceland Redwings (*T. m. coburni*) went on through St. Kilda during the last ten days of April, and also of Snipe (*Capella gallinago*) and Redshank (*Tringa totanus*) on the 29th.

Throughout the first fortnight of April, numbers of Water Rails (*Rallus aquaticus*) were reported as unusually high in Kent where, for example, at Dungeness 20 were ringed between 31st March and 16th April, and on one day 10 were flushed together. Isolated reports from elsewhere in Britain also tend to suggest an influx of this species. At Dungeness the numbers dropped away after the 16th, with one only on most days to the 29th and then no more.

An adult male Dartford Warbler (*Sylvia undata*) was ringed at St. Catherine's lighthouse, Isle of Wight, at 03.45 hours on 14th April. This species does not often figure as a passage bird and so it is of interest to add that, last autumn, two separate individuals were recorded at Dungeness: one on 17th October and another on the 26th and 27th.

On 18th April the cold weather let up and the main "release" rush of summer migrants—Redstarts, Whitethroats (*Sylvia communis*), Pied Flycatchers (*Muscicapa hypoleucos*), Blackcaps, Garden Warblers (*Sylvia borin*), Nightingales (*Luscinia megarhynchos*) and so on—followed almost immediately. The peak nights for arrival on the south coast seem to have been those of 19th/20th, 20th/21st, 21st/22nd and 24th/25th. Swifts (*Apus apus*), which do not normally appear until the very last days of April, were surprisingly then reported from several places on the 21st and there had been a considerable influx by the 26th; they reached Cheshire in force by 30th April, which is some 7-10 days early. There was a small influx of Blue-headed Wagtails (*Motacilla f. flava*) at Cley, Norfolk, on 25th April; and on 30th April, for the second year in succession, a number (5 on that day) of *beema*-type wagtails appeared at Beddington, Surrey; in 1957 a group of these nested there. Then the first three days of May saw a considerable movement of Black Terns (*Chlidonias niger*): reports on the 1st included 120 at Pitsford reservoir, Northamptonshire, 160 at Rockland Broad, Norfolk, and 36 at Stewartby, Bedfordshire; on the 2nd there were 104 at Tring, Hertfordshire, 100 at Abberton reservoir, Essex, and over 400 at Hanningfield near-by; and on the 3rd 160 arrived at Hanningfield in the evening. Reports of Black Terns at this time have come from counties as far apart as Lancashire, Lincolnshire, Oxfordshire, Kent and Hampshire, but 23 is the largest number so far reported outside the area bounded by the counties already mentioned.

There have been a number of rarer birds in recent weeks, apart from those already mentioned, and the following reports are worth noting. One apparent Lesser Scaup (*Aythya affinis*) was still present at Sutton Courtenay, Berkshire, on 15th April (see *antea*, pp. 40 and 131), and on 27th and 28th April yet another was found at Hanningfield Reservoir, Essex: the exact identity of these birds is still being examined. On Islay, in the Inner Hebrides, a very small, short-necked and dark Canada Goose (*Branta canadensis*) was located on 5th April among a flock of 1,000 Barnacle Geese (*B. leucopsis*): from the

description it seems very likely that this was of the tiny Alaskan race (*B. c. minima*), known as the Cackling Goose, in which case it appears that it cannot have escaped from captivity. A Great Snipe (*Capella media*) was reported from Cley, Norfolk, on 9th April, and two Black-winged Stilts (*Himantopus himantopus*)—apparently a pair—on the Hayle estuary, Cornwall, on 19th April, and probably 20th; during 21st-24th another mainly south European bird, an immature Purple Heron (*Ardea purpurea*), was seen on St. Agnes, Scilly Isles; and perhaps this is an opportune moment to mention that a juvenile Night Heron (*Nycticorax nycticorax*), which may have come from S. Europe or from Edinburgh Zoo (see *antea*, vol. xlvii, pp. 353-354; *Scot. Nat.*, vol. 69, pp. 32-36), was picked up dead near Mersham, Kent, on 2nd February. An immature Crane (*Grus grus*) was identified at Saltwood, Kent, on 5th April, and an adult near Chevington Drift, Northumberland, on 29th and 30th (*cf. antea*, pp. 131 and 164). Single Spoonbills (*Platalea leucorodia*) appeared at Cley, Norfolk, on 25th April; on the Welland estuary, Lincolnshire, on the 29th (immature); and at Hanningfield reservoir, Essex, on 3rd May (immature). On 29th March a Spotted Crake (*Porzana porzana*) was heard calling at Leeds Castle, Kent, and on 7th April another was flushed at Stodmarsh in the same county. A female Kentish Plover (*Charadrius alexandrinus*)—only the third record of this species in Middlesex this century—was reported from Staines on 1st April, and there was a male at Aberthaw, Glamorgan, on 7th April—the first in the latter county since a doubtful occurrence in 1888. Single adult Mediterranean Black-headed Gulls (*Larus melanocephalus*) were seen at Southsea, Hampshire, during 6th-21st February and at Brighton, Sussex, on 25th and 26th March (see *antea*, pp. 132 and 164), while one that was first seen at Hartlepool, Co. Durham, on 1st August 1957 was still there on 9th April. The 2nd-year Iceland Gull (*L. glaucoides*) at Southwick, Sussex (*antea*, p. 132), was last seen there on 11th April; what may or may not have been the same bird was noted at Shoreham, near-by, on 30th March and on several occasions to 1st May. An Iceland Gull was also seen at St. Mary's Bay, Thames, Kent, on 29th March, and it is interesting to note that there was a 2nd-year bird on St. Kilda during the last fortnight of April. Single Glaucous Gulls (*L. hyperboreus*) were reported from Bardsey Island on 24th March and 6th April—the first records for the Observatory. A party of 5 Lesser Short-toed Larks (*Calandrella rufescens*) was identified on Great Saltee, Co. Wexford, during 22nd-25th March: this is the fifth occasion (and the fourth in Ireland) that small parties of this species have been reported in the last four years and it is hoped to publish a full statement in due course. Single Richard's Pipits (*Anthus richardi*) were identified at Staines reservoir, Middlesex, on 12th April and again (King George VI reservoir) on the 30th; and at Beddington, Surrey, on the 17th and 18th April. Incidentally, rather unusual inland, single Lapland Buntings (*Calcarius lapponicus*), a male and a female respectively, were reported at Beddington (5th April) and Staines, Middlesex (13th April). A party of, to judge from the description, Mealy Redpolls (*Carduelis f. flammea*) was present near Walberswick, Suffolk, during 7th-18th April, the greatest number being 21 or 22 on the 8th.

Avocets (*Recurvirostra avosetta*) and Kites (*Milvus milvus*), neither of which are much recorded away from their habitual areas, have both been more in evidence in recent weeks. Apart from the first-summer Avocet at Budle Bay, Northumberland—mentioned last month (*antea*, p. 164)—which I now understand was first seen on 15th February and still present on 14th April, Avocets have been reported in Herefordshire (2 during 27th March-1st April at Parton, near Eardisley), in Norfolk (2-14 during 4th-11th April at Cley, and subsequently 5 at Burnham Overy), in Kent (one on 6th April at Littlebrook, and one on the 7th at Sheppey), in Yorkshire (2 on 6th April at Spurn, then 3 on the 7th and one during the 8th-9th), in East Lothian (5 on 6th April at Aberlady Bay, then 3 during the 9th-10th and 2 on the 11th), and in Hampshire (2 at Farlington Marshes on 19th April): it will be noticed from these dates that there was evidently an immigration about 4th-6th April, and it was in fact at just this period that the main population returned to Suffolk. Kites were reported from North Walsham, Norfolk, on 3rd March; from Launcells,

Cornwall, on 10th March; from Dungeness, Kent, on 5th April; and from Long Dean, Wiltshire, on 13th April—apart from those mentioned last month (*antea*, p. 164)—as well as incomplete or uncertain cases in Middlesex, Lincolnshire, Cheshire and Yorkshire. A Rough-legged Buzzard (*Buteo lagopus*) at Sandringham, Norfolk, on 12th March and an Osprey (*Pandion haliaëtus*) near Ingatestone, Essex, on 21st April were the only other interesting birds of prey reported.

Several previous references have been made to inland Long-tailed Ducks (*Clangula hyemalis*) and Eiders (*Somateria mollissima*) during this past winter (*antea*, pp. 40, 84, 132 and 164), and reports of the former continue to come in, with the total of counties raised to seventeen by the inclusion of Glamorgan, Gloucester, Somerset, Lancashire and Lanarkshire, apart from another in Perthshire; several southern counties, including both Kent and Cornwall, report that Long-tailed Ducks have been seen off the coast more frequently than ever before. Another inland Eider occurred near Pymore, Cambridgeshire, on 8th March. More recently, however, it has been the Common Scoter (*Melanitta nigra*) that has been the sea-duck of lakes and reservoirs, and during April there were reports from Bedfordshire (pair at Wyboston on 5th April, and a female at Bedford on the 22nd), Warwickshire (male at Alvecote on 5th April and female there on the 8th), Worcestershire (female at Kidderminster on the 13th), London (female at Dulwich on the 17th), Cambridgeshire (two females at Waterbeach on the 17th) and Hertfordshire (one at Tring reservoirs on the 20th)—quite apart from rather unusual numbers a few miles inland at Abberton, Essex, and at Chew, Somerset, where there were 9 and 15 respectively on 5th and 6th April: thus suggesting that the influx inland took place in the first week of the month. On 6th April there was a pair of Velvet Scoters (*M. fusca*) inland on Portmore Loch, Peebleshire. A Black-throated Diver (*Gavia arctica*) at Cannock Chase reservoir, Staffordshire, on 30th March and 10th-12th April, was another unusual inland report.

To bring up to date the picture shown by several other species in recent months. First of all, a correction: the two drake Red-crested Pochards (*Netta rufina*) at Stanford Reservoir were seen on 15th March (not 4th—*cf. antea*, p. 164) and this sheet of water, though near Rugby, is actually on the Leicestershire/Northamptonshire border; what were almost certainly the same two birds were seen the next day, 16th March, at Napton Reservoir which lies about 12 miles to the south-west, between Leamington and Daventry. A number of March and April Shags (*Phalacrocorax aristotelis*) suggested that the survivors of the January/February "wreck" (*antea*, p. 131) were making their way back: these did not include more than one or two far inland reports, but 11 (1 dead) at Abberton, Essex, on 27th March, for example, and arrivals on the Sussex, Kent and Essex coasts, and on the Ouse Washes in Cambridgeshire, between mid-March and 13th April, indicated a northward movement round the south-east corner of England. Several reports during late March and the first half of April support the suggestion of a return movement of tits (*Parus* spp.) (see *antea*, pp. 162-163). Bardsey, Portland and Dungeness have all reported movements of Blue Tits (*P. caeruleus*) and smaller numbers of Great (*P. major*), and reed-beds in East Anglia have again been full of Blue Tits; there have now been several recoveries from the Continent of tits ringed in this country since last autumn's immigration. Coal Tits (*P. ater*), however, have not been much in evidence and only Bardsey (single birds on 7th and 20th March) has reported any movement of this species. There have been still further reports confirming an influx of Stonechats (*Saxicola torquata*) in mid-February and early March (see *antea*, pp. 132 and 164), and Fair Isle had about 6 different individuals during this period—more than for many years; in February and again at the end of March they appeared at Skokholm and there were more at Great Saltee during 22nd-25th March than have ever been recorded there before.

Finally, data are still coming forward concerning an apparent influx of Water Pipits (*Anthus s. spinoletta*) and other Continental populations of the Rock Pipit: the picture is not yet complete.

## NOTICE TO CONTRIBUTORS

*British Birds* publishes material dealing with original observations on the birds of Britain and western Europe, or, where appropriate, on birds of this area as observed in other parts of their range. Except for records of rarities, papers and notes are normally accepted only on condition that the material is not being offered to any other journal. Photographs (glossy prints showing good contrast) and sketches are welcomed. Proofs of all contributions accepted are sent to authors before publication. After publication 20 separates of papers are sent free to authors; additional copies, for which a charge is made, can be provided if ordered when the proofs are returned.

Contributors are asked to observe the following points, attention to which saves the waste of much editorial time on trivial alterations:

1. Papers should be typewritten with double spacing, and on one side of the sheet only. Shorter contributions, if not typed, must be clearly written and with similar spacing. Failure to help in this way may result in delays to publication.

2. Notes should be worded as concisely as possible, and drawn up in the form in which they will be printed, with signature in block capitals and the writer's address clearly written on the same sheet. If more than one note is submitted, each should be on a separate sheet, with signature and address repeated. In the case of rarity records, any supporting description which is too detailed for publication should be attached separately.

3. Certain conventions of style and lay-out are essential to preserve the uniformity of any publication. Authors of papers in particular, especially of those containing Systematic Lists, Reference Lists, Tables, etc., should consult the ones in this issue as a guide to general presentation. English names of species should have capital initials for each word, except after a hyphen (e.g. Siberian Thrush, Yellow-headed Wagtail), but group terms should not (e.g. thrushes, wagtails). English names are those used in *The Handbook of British Birds*, with the exception of the changes listed in *British Birds* in 1953 (vol. xlvi, pp. 2-3). The scientific name of each species should be given (in brackets and underlined) immediately after the first mention of the English name. Sub-specific names should not be used except where they are relevant to the discussion. It is sometimes more convenient to list scientific names in an appendix. Dates should take the form "1st January 1955" and no other, except in Tables where they may be abbreviated to "1st Jan.", "Jan. 1st", or even "Jan. 1", whichever most suits the lay-out of the Table concerned. It is particularly requested that authors should pay attention to Reference Lists, which otherwise cause much unnecessary work. These should take the following form:

TUCKER, B. W. (1949): "Species and subspecies: a review for general ornithologists". *Brit. Birds*, xlii: 129-134.

WITHERBY, H. F. (1894): *Forest Birds: Their Haunts and Habits*. London. p. 34.

Various other conventions concerning references, including their use in the text, should be noted by consulting previous examples.

4. Tables should be numbered with Roman numerals, and the title typed above in the style used in this issue. The title and any headings within the Table should not be underlined, because this sometimes makes it difficult for the Editor to indicate the type to be used. It is most important that the lay-out of each Table should be carefully planned with an eye to its final appearance; above all, it should be borne in mind that Tables must either fit into the width of a page, or be designed to fit a whole page lengthways. All Tables should be self-explanatory.

5. Figures should be numbered with Arabic numerals, and the captions typed on a separate sheet. All line-drawings should be in Indian ink on good quality drawing paper (not of an absorbent nature) or, where necessary, on graph paper, but this must be light blue or very pale grey. It is best if maps, graphs, etc., are drawn twice the size of the final reproduction (ideally, therefore, for the normal 4" width the original should be 8" wide); sketches of birds, however, should be only slightly larger than the size at which it is intended they should appear. It is always most important to consider how each drawing will fit into the page. The neat insertion of lettering, numbers, arrows, etc., is perhaps the most difficult part of Indian ink drawing and, unless he has had considerable experience of this kind of work, an author should seek the aid of a skilled draughtsman. The publishers regret that, owing to rising costs, it will in future be only in exceptional cases that they can undertake to have lettering inserted.



# SS 12x60

BLOOMED LENSES



In 1939 Czechoslovakia was renowned for precision engineering and the Meopta Company

of Prague had established a world reputation for precision optical instruments. The outbreak of the Second World War brought the disruption of international trade and subsequently the Meopta products became completely absorbed by the German Armed Forces. Since the end of hostilities, a limited quota of Meopta binoculars is sanctioned for the United Kingdom.

**THIS IS THE ONLY IMPORTATION OF CZECHOSLOVAKIAN BINOCULARS TO ENTER BRITAIN SINCE 1939.**

The construction of a binocular with a 60 mm. object lens presents technical difficulties not encountered in the production of the smaller types and the normal price is about £70.

The Meopta 12 × 60 has the rare combination of high magnification and brilliant light gathering power, even at night and under bad climatic conditions. The superb optical performance is an outstanding achievement in binocular construction.

The price, including the leather case and lanyard, is **£31 10s. 0d.**

Sole distributor in the United Kingdom,

## THOMAS PARRY

52, KNIFESMITH GATE,  
CHESTERFIELD.

Telephone 4906

37, SOUTH MOLTON ST.,  
LONDON, W.1.

Telephone : Mayfair 3167

Personal callers welcomed.

*Otherwise Cheque or Money Order crossed, payable THOMAS PARRY, should accompany your name and address, BLOCK LETTERS PLEASE. Binoculars cannot be sent on approval, but satisfaction or full cash refund guaranteed.*



# BRITISH BIRDS



JUNE 1958

THREE SHILLINGS

# BRITISH BIRDS

AN ILLUSTRATED MONTHLY MAGAZINE

Edited by

E. M. NICHOLSON

W. B. ALEXANDER

A. W. BOYD

I. J. FERGUSON-LEES

P. A. D. HOLLOM

N. F. TICEHURST

*Editorial Address* : 30, St. Leonard's Avenue, Bedford.

*Photographic Editor* : G. K. YEATES

Annual Subscription £2 (including postage and despatch)  
payable to H. F. & G. Witherby Ltd., 5, Warwick Court, London, W.C.1

---

---

## CONTENTS OF VOLUME LI, NUMBER 6, JUNE 1958

---

	PAGE
Bergmann's Rule and obligatory overseas migration. By Kenneth Williamson ... ..	209
Photographic studies of some less familiar birds. LXXXIX—Goshawk. Photographed by Kurt Ellström and Jonas Svensk (plates 37-40). Text by I. C. T. Nisbet ... ..	233
Obituary: John Arthington Walpole-Bond (1878-1958) ... ..	237
Notes:—	
The identification of White-headed and Ruddy Ducks (I. J. Ferguson-Lees) ... ..	239
Red Grouse swimming (C. H. Fry) ... ..	241
Partridges apparently affected by industrial contamination (Dr. J. S. Ash) ... ..	241
Exceptional passage of Black Terns through Somerset in September 1957 (M. W. Pickering) ... ..	242
Lanceolated Warbler at Fair Isle (Peter Davis) ... ..	243
Reviews:—	
<i>Audubon Bird Guide</i> , <i>Audubon Water Bird Guide</i> and <i>Audubon Western Bird Guide</i> . By Richard H. Pough. Illustrated by Don Eckelberry, Earl L. Poole and Terry M. Shortt ... ..	244
Letter:—	
Social Rying by Ravens (Sir Landsborough Thomson) ... ..	246
Recent reports and news. By I. J. Ferguson-Lees and Kenneth Williamson ... ..	247

---

Cover photograph by Kurt Ellström and Jonas Svensk: female Goshawk (*Accipiter gentilis*) at nest

1<sup>st</sup> PURCHASED  
24 JUN 1958

VOL. LI  
No. 6



## BRITISH BIRDS

---

### BERGMANN'S RULE AND OBLIGATORY OVERSEAS MIGRATION

By KENNETH WILLIAMSON

(*Migration Research Officer, British Trust for Ornithology*)

#### INTRODUCTION

IN THE STUDY of natural history there are well-known ecogeographical (sometimes called "climatic" or "ecological") rules relating certain characteristics of warm-blooded animals to the conditions of their environment.

One of the best-known in its application to birds is Bergmann's Rule, which states that in a polytypic species the body-size of a subspecies tends to increase with the decreasing mean temperature of its habitat. Thus body-size, as indicated by an average lengthening of the wing, shows a tendency to increase with latitude; and the wings of populations which live at high altitudes tend to be longer than those of the same species residing in lowland areas. As Huxley (1942) pointed out, this is really a part of the more general principle that in warm-blooded animals body-surface relative to bulk tends to diminish with decreasing mean temperature of the environment; it is an adjustment compensating the organism, since the smaller the body the more heat it radiates to the colder outer air. This correlation has been criticised by Scholander (1955) on the grounds that there are more efficient adaptations for conserving body-heat, but their existence does not necessarily invalidate the hypothesis as a partial interpretation of Bergmann's Rule. There are some striking exceptions (Rensch estimates 16 per cent in Palaearctic birds) to the general rule, and the reasons for such exceptions are not always clear. There are many aspects to the problem, and the selection pressures which have combined to produce (or, in some cases, suppress) this "latitude effect" are manifold. Mayr (1956) insists that it must be regarded as "a purely empirical finding which

can be proven or disproven no matter to what physiological theory one might ascribe this size trend", and he warns strongly against the search for an all-or-none solution to this complicated biological problem.

The scope of the present discussion is a limited one, aiming to show that one of the contributory factors which must be taken into account in considering this "latitude effect" in certain species is the selection pressure exerted during the comparatively brief periods of the biennial migration. For, as Mayr has emphasized, the working of natural selection is particularly efficient during catastrophes and other periods of great environmental stress, so that even the short-term influence of a long migratory flight may be expected to play its part.

Some consideration has already been devoted to the nature of this "latitude effect" in migratory species, though much of this has been concerned with the bird in its winter quarters and little of it with the actual journey which takes it there, and which returns it to the breeding-ground in spring. Rensch (1939) showed that a size-correlation could often be found with the minimum winter temperature of the environment, selection being exerted by the most rigorous life-conditions. This suggests that in migratory species the body-size of a northern population is likely to be a function of selection due to the off-season environment rather than the high latitude of the breeding-area.

Thus Hemmingsen (1951) proposed that if we are to test the validity of Bergmann's Rule in migratory species, it is to the winter rather than the summer range that we must look for an answer. He further pointed out that the timing of migration might also be involved since some subspecies, and also members of closely-allied species, return earlier in the season, under colder weather conditions, than others—as, for example, the Curlew (*Numenius arquata*) and Whimbrel (*N. phaeopus*), the Slender-billed Knot (*Calidris tenuirostris*) and Common Knot (*C. canutus*). In these couples an association is apparent, on the one hand, between early spring movement, greater body-size and relatively northern winter quarters, and, on the other hand, a later migration in milder weather, smaller body-size and relatively warmer and more southerly wintering grounds.

Salomonsen (1955) has also discussed at some length the effects due to selection pressure in the winter range, and has shown convincingly that there are cases in which a marked correlation exists between Bergmann's Rule and the rigour of conditions in the winter environment. This is especially so with those races of a species which practise allohiemy, or which (in other words) are segregated in different regions outside the breeding-season. Once such allohiemy has been established, differences in the selective factors operating in the two regions will tend to encourage sub-specific differentiation. The Ringed Plover (*Charadrius hiaticula*) affords an excellent example, for here we find a reversal of the

normal "latitude effect" in that the smallest race *tundrae* nests farthest north in the total range; however, its migration "leap-frogs" the range of the typical race, and its smaller size is really a response to the warmth of a tropical wintering-area. Salomonsen sees a similar state of affairs in the races of the Redshank (*Tringa totanus*), but there is a difficulty, which we shall refer to again below, in the case of the Icelandic form.

Salomonsen's contribution is of great importance to the study of evolution and subspeciation in birds; but there remain certain populations, notably among the land-birds of Greenland and Iceland, whose divergence from their Continental relatives cannot be satisfactorily accounted for on his, Hemmingsen's, or any other hypothesis so far advanced. There are striking cases among these migratory land-birds in which it seems probable that selection operates most powerfully during the brief migratory periods; for, in comparison with their Continental relatives, they are called upon to perform twice yearly an obligatory overseas flight, with all its attendant hazards of migrational drift away from the most direct route. The rigours of these long flights are such that survival favours the more robust individuals possessing the greatest resources of energy (stored glycogen and fats); so that in the course of many generations the stock has developed a greater body-size by comparison with populations following coastal or overland migration-routes. This increased size is primarily apparent in a greater weight, and secondarily in an allometric increase in the length of wing and tail.

It is worth while looking more closely into this situation in respect of certain breeding-birds of Iceland and Greenland, whose brief arctic summer is passed under conditions not as a rule more rigorous than those obtaining at similar latitudes in continental Europe. The fullest discussion will be given to the most striking example, the Wheatear, and a number of other species will be discussed at shorter length, with a view to determining to what extent they fall into line with the above hypothesis.

#### WHEATEAR (*Oenanthe oenanthe*)

The typical race of the Wheatear breeds over the whole of Europe, extending north of the Arctic Circle, while a large form *Oenanthe oe. leucorrhoea* is a common breeder in the low Arctic region of Greenland, and also nests, though more locally, in the southern part of the high Arctic region. Salomonsen (1950-51) says "The Wheatear is much more common in the interior fjord country with a dryer and warmer climate and a rich insect-life than in the coastal areas, where it is rather scarce. It has its greatest population density in the south (Julianehaab District) and becomes less numerous towards the north". The interior fjord country of the Julianehaab District is actually sub-Arctic in climate, and at about 61°N. is considerably south of the Arctic Circle and indeed at much the same latitude as Shetland. Wynne-

Edwards (1952) found this form abundant at the head of Clyde Inlet, Baffin Island, about 70°N., and it nests sparingly in other parts of the east Canadian Arctic. The Wheatear is common in Iceland and the Faeroe Islands: in the south of Iceland and Faeroe the birds are intermediate between *oenanthe* and *leucorrhoa* and have been named *Oenanthe oe. schiøleri*. Table I gives wing-measurments of these populations and is taken from Salomonsen (1950-51).

TABLE I—WING-MEASUREMENTS OF DIFFERENT POPULATIONS OF WHEATEARS (*Oenanthe oenanthe*) (after Salomonsen, 1950-51)

Origin	Males			Females		
	No.	Range (mm.)	Average	No.	Range (mm.)	Average
Greenland	36	102-110	105.00	37	100-108	103.37
Iceland	49	99-107	102.55	23	96-103	98.81
Faeroe Is.	22	97-103	99.61	13	95-101	97.54
Scandinavia	56	92-99	96.38	36	89-97	93.22

A group of Wheatears, of medium wing-length and decidedly heavier than the local stock (and presumably the so-called *schiøleri* of south Iceland and Faeroe origin) migrates through Fair Isle regularly each autumn during the last ten days of August. Fair Isle and Shetland birds are smaller and are referable to *oenanthe*.

The Greenland Wheatear (including the Canadian Arctic stock) migrates through western Europe and winters mainly in tropical west Africa, along with birds of the typical race. The majority of the Greenland birds arrive on their breeding-grounds in middle and late May, but many do not reach the northern limits till early June (Salomonsen, 1950-51). This agrees well with the passage-dates at Fair Isle, movement being evident in early and mid-May, and occasionally as early as the last week of April—though Ticehurst (1909) gives this as the normal time of arrival in southern England. This means that the bigger race is subject to "warmer" climatic conditions during its spring journey than the typical form, which reaches Britain late in March and continues to pass throughout April; and thus the Wheatear provides an exception to Hemmingsen's rule that in related forms the smaller one moves later and under more congenial weather conditions. In autumn there is a difference of up to a fortnight, local and Shetland birds leaving in bulk from mid-August, the intermediate type passing during the last week or so of the month, and the big *leucorrhoa* from the beginning of September.

It is interesting to consider the migration in relation to the greater body-weight of the Greenland race. Spring passage at Fair Isle is steady and protracted, with birds much less numerous than in autumn, when of course the majority are young of the year. (1956 showed a reversal of this situation, the spring migration being quite exceptionally heavy, and the fall migration unusually slight.) At both seasons, specimens of *leucorrhoa* show a wide

variation in weight (Table II), though in general the heaviest birds pass in the spring and the lightest occur (often in fairly homogeneous groups) in the fall (note the low weights in Table IV). It is possible that the light spring birds reach Fair Isle as the result of wind-drift when attempting to cross the Atlantic from an Irish or west-coast starting-point, while others apparently come in with Continental migrants displaced from the North Sea coast and Skagerrak by easterly winds.

TABLE II—WEIGHTS OF GREENLAND WHEATEARS (*Oenanthe oc. leucorrhoa*) TRAPPED ON SPRING PASSAGE AT FAIR ISLE, TO SHOW THE GREAT VARIATION

Year	Heavy Birds			Light Birds		
	No.	Range (gm.)	Average	No.	Range (gm.)	Average
1949	4	29.20-37.40	33.63	5	21.45-24.71	23.07
1950	5	29.11-33.33	30.67	1		26.13
1951	3	30.13-35.65	32.38	2	23.19-26.65	24.94
1952	8	28.00-38.08	32.52	1		24.50
1953	5	33.62-43.19	37.75	3	21.48-26.07	24.18
1954	6	27.21-38.81	32.01	2	21.21-26.70	23.95
1955	7	27.43-37.39	32.82	2	24.41-25.35	24.88

For the most part, however, these spring birds are pursuing a northwards course under optimum conditions, for much of their migration takes place when there is anticyclonic weather over the British Isles. Since they reach Fair Isle from the north of Scotland and Orkney they have made only a negligible sea-crossing, and may be presumed to have expended very little of the reserves of energy built up by an adequate food-supply whilst travelling through Britain. The opposite situation occurs in autumn when col or anticyclonic weather provides calms or light airs to the north, and in some seasons a vast Wheatear movement is released by such weather in the Faeroe-Shetland region in the last week of August. As is to be expected, the best weights are recorded in spring, with individuals occasionally exceeding 40 gm.—viz. ♂♂, 30th April 1953, 43.2 gm. (wing 109 mm.), 5th May 1956, 41.2 gm. (wing 107 mm.); ♀♀ 4th June 1953, 42.7 gm. (wing 98 mm.), 5th May 1955, 41.1 gm. (wing 97 mm.). A detailed analysis of the weights of Wheatears captured in the spring at Fair Isle has been undertaken by Alec Butterfield, and this reveals a striking difference between *leucorrhoa* on passage and locally-resident *oenanthe* (Table III).

TABLE III—COMPARISON BETWEEN THE WEIGHTS OF ALL GREENLAND WHEATEARS (*Oenanthe oc. leucorrhoa*) TRAPPED ON SPRING PASSAGE AT FAIR ISLE AND THOSE OF THE LOCALLY-RESIDENT STOCK (*Oe. oc. oenanthe*)

	Males		Females	
	<i>leucorrhoa</i>	<i>oenanthe</i>	<i>leucorrhoa</i>	<i>oenanthe</i>
Numbers of specimens	30	45	24	35
Mean Weight in gm.	30.98	24.11	30.25	23.80
Standard Deviation	5.62	2.38	4.41	2.08
Ratio of Mean Weight to Standard Deviation	5.51	10.13	6.86	11.44

We should expect the weight of *leucorrhoa*, before setting forth in autumn, to be at least as much as that of spring migrants trapped under ideal anticyclonic conditions. In the absence of a series of weights collected on the breeding-grounds between the finish of moult and the birds' departure, our discussion must be limited to the samples available from passage migrants at Fair Isle. There is an even wider variation than in the spring, and the maximum records do not go quite so high, the majority of those passing through in comparable anticyclonic weather registering around 35 gm. As these birds have had fairly long stretches of the sea to cross on the "inter-islands" route via Faeroe and Shetland, somewhat lower weights are to be expected. Sometimes, however, there are incursions of long-winged birds at exceptionally low weights, around 20 gm. only; and the fact that groups of these lightweight birds appear quite suddenly on the island suggests that an explanation for their condition should be sought in their recent migrational history.

The events of early September 1953 present an excellent case for analysis. An interesting dual arrival of Wheatears took place between the 1st and 3rd, at a time when the picture was unlikely to be confused by the presence in the catch of local birds, since the majority of these had already departed. Trappings were about equally divided between long-winged, long-tailed *leucorrhoa* and small *oenanthe* with measurements less than the means for the local population. The meteorological setting showed an Atlantic low moving north-eastwards between Greenland and Britain, with a warm front extending across the North Sea from northern Scotland to the Skagerrak (Fig. 1). With strong anticyclonic developments over both Greenland and Norway conditions were ideal for departure from both countries, and the situation of this low resulted in a cyclonic westerly airstream over the Atlantic and an easterly one ahead of the warm front in the North Sea. With the passing of a low to Norway on 4th September, and the advance of another towards southern Greenland, conditions inhibiting further migration reached both countries, and a long cigar-shaped ridge of a central European high extending northwards beyond Shetland and Faeroe brought ideal migration weather, with calms and light-to-moderate northerly breezes, to the "inter-islands" route (Fig. 2). These changes effectively sealed off further influxes of Greenland and Continental Wheatears, and resulted instead in the passage through Fair Isle on 5th September of intermediate *schioleeri*-type Wheatears from the islands to the north. This was, in effect, a resumption of the normal late August passage of such birds, which had been effectively blocked by the passing depression of 1st-3rd.

The birds of medium wing-length on 5th September showed the best weights, averaging close on 28 gm. (Table IV C). Although the *leucorrhoa* of 1st-3rd must have been substantially heavier than this, and the small *oenanthe* lighter, at the start of their respective



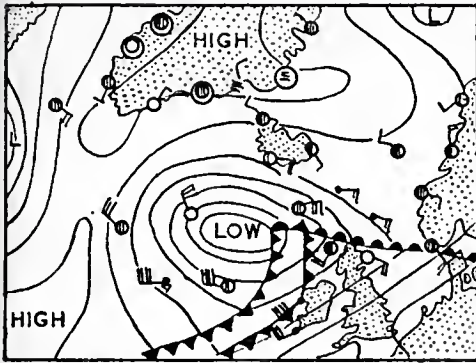

Fig. 1

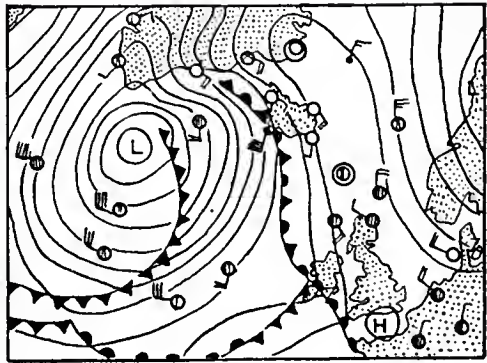

Fig. 2

FIGS. 1 and 2—AUTUMN MIGRATION OF WHEATEARS (*Oenanthe oenanthe*)  
 Weather-charts for mid-day on 1st and 4th September 1953, to illustrate (Fig. 1) the cyclonic arrival at Fair Isle, on 2nd September, of *oenanthe* from the east and *leucorhoa* from the west; and (Fig. 2) the resumption of passage at Fair Isle, on the 5th, of *schjølteri* intermediate birds in an anticyclonic ridge (see page 214).

journeys, both forms were extremely light and in fact about equal in weight on arrival at Fair Isle (Tables IV A and B). The small birds had made a fortuitous sea-crossing of 300-400 miles in the easterly airstream ahead of a warm front; the large ones, whose loss was proportionately very much greater, had made a trans-Atlantic crossing in the cyclonic wind-stream on the other side of the depression, covering a distance which seems likely to have been of the order of 1,600 miles.

To complete this picture of the correlation between body-weight and the synoptic pattern of the migration, it might be added that some intermediate ("*schjølteri*") birds were trapped on 8th September in circumstances suggesting a similar cyclonic passage round the western half of a small low centred about  $60^{\circ}\text{N}$ .  $40^{\circ}\text{W}$ . with a warm front and west wind reaching eastwards to Fair Isle. The drift-track for these birds, on a down-wind reckoning, would be of the order of 1,200 miles or about twice the airline distance via the "inter-islands" route, and it is interesting to compare their low arrival weights (Table IV D) both with the records of the better-favoured "*schjølteri*" of the 5th, and the *leucorhoa* of the 1st-3rd.

Wheatears of the Greenland race are frequently encountered out in the Atlantic in spring and autumn, and the large form is known as an accidental visitor or passage migrant in the Azores and Canary Islands, its occurrence in the latter archipelago showing a September peak (Bannerman, 1919). The spring and autumn distribution of records at sea has been plotted by Snow (1953), who concluded that crossings are made regularly in autumn from south-east Greenland direct to western Europe, while in spring "the shortest possible sea-crossing is normally made, the birds travelling northwards, largely overland, up through western Europe and the British Isles". Such records as I have examined in juxtaposition

TABLE IV—ANALYSIS OF WHEATEARS (*Oenanthe oenanthe*) TRAPPED AT FAIR ISLE IN EARLY SEPTEMBER 1953, TO SHOW CORRELATION BETWEEN THE METEOROLOGICAL CONDITIONS (see Figs 1-2 and pages 214-215), THE POPULATIONS INVOLVED AND THE BODY-WEIGHTS ON ARRIVAL

(A)—Greenland birds ( <i>Oe. oe. leucorrhoa</i> )					(B)—Continental birds ( <i>Oe. oe. oenanthe</i> )				
	Age/Sex	Wing (mm.)	Tail (mm.)	Weight (gm.)		Age/Sex	Wing (mm.)	Tail (mm.)	Weight (gm.)
1.ix	1st w.	102	59	18.98	2.ix	1st w.	95	55	23.75
2.ix	Ad. ♀	103	59	25.59	"	"	96	55	23.43
"	Ad. ♂	100	59	22.40	"	"	93	53	24.67
"	"	103	59	27.18	"	"	88	50	19.29
"	Ad. ♀	102	59	23.71	"	"	91	52	26.06
"	"	106	63	22.60	"	"	91	53	24.95
3.ix	Ad. ♂	107	62	23.80	"	Ad. ♂	96	51	21.21
"	1st w.	105	63	21.96	3.ix	1st w.	93	50	17.19
"	Ad. ♂	102	60	21.34	"	"	93	55	20.02
"	Ad. ♀	98	58	20.32					
"	Ad. ♂	102	62	20.88					
4.ix	"	107	65	23.55					
"	1st w.	102	62	22.74					
	Average:	103	60	22.69		Average:	93	52½	22.28

(C)—Iceland-Faeroe birds ( <i>Oe. oe. "schioleri"</i> )				
	Age/Sex	Wing (mm.)	Tail (mm.)	Weight (gm.)
5.ix	Ad. ♂	95	55	30.50
"	"	95	55	25.44
"	1st w.	97	57	26.70
"	"	98	56	29.83
"	"	96	55	27.15
	Average:	96	55½	27.92

(D)—Iceland-Faeroe birds ( <i>Oe. oe. "schioleri"</i> )				
	Age/Sex	Wing (mm.)	Tail (mm.)	Weight (gm.)
8.ix	?	97	56	22.25
"	1st w.	95	55	23.19
"	"	94	55	22.22
9.ix	Ad. ♀	99	57	23.20
	Average:	96	55½	22.71

to the appropriate weather charts substantially confirm Snow's conclusions.

There is a crop of interesting records, from two sources, of spring birds in the Atlantic between 8th and 11th May 1952. A. P. Ryan, on board the weather-ship *Weather Observer* at 52°30'N., 20°W., saw 6 birds on 8th May, of which 4 came on board "in poor condition—very tired", and 2 flew past, separately, heading north-east. Single Wheatears were also seen on the 7th and the 9th, and there had been a Greenland ♀, wing 100 mm., on the 5th. The wind was N.N.W. on the 5th-6th, veering northerly on the 7th and further to the N.E. on the 8th as a depression moved eastwards (Fig. 3): its force decreased from gale on the 6th-7th to force 4 on the 8th, a fair but cloudy day. A number of birds were also seen by E. F. Aikman, westward-bound in *Empress of France* on 9th and 10th May between 53°N. 30°W. and 49°N. 47°W. The weather was overcast and rather misty and the ship was just clearing the region influenced by this depression (Fig. 4). When *Weather Observer* was returning to base on 11th May 3 Wheatears came on board at 54°N. 14°W. (Fig. 5).

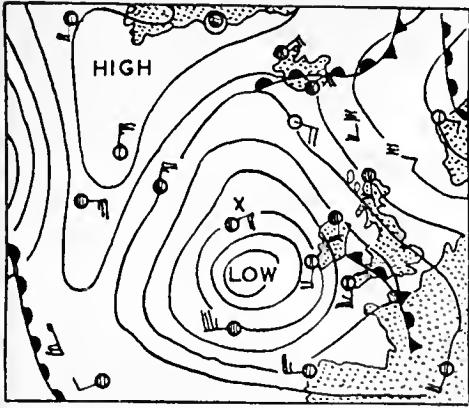

Fig. 3

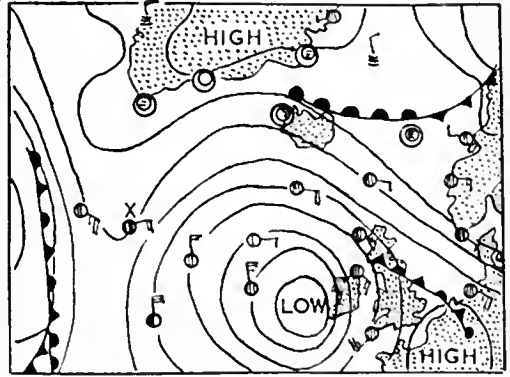

Fig. 4

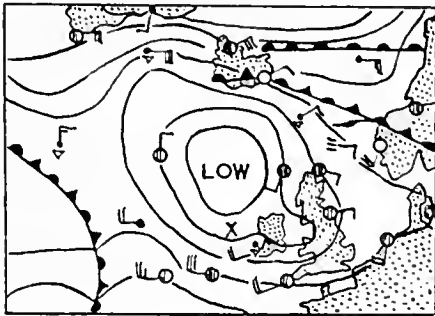

Fig. 5

FIGS. 3, 4 and 5—OCCURRENCES OF WHEATEARS (*Oenanthe oenanthe*) AT SEA Weather-charts for mid-day on 8th, 9th and 11th May 1952, to illustrate the conditions that resulted in the arrival (Fig. 3) of six Wheatears at a weather-ship on 8th May; (Fig. 4) of several at R.M.S. "Empress of France" on the 9th; and (Fig. 5) of three at a weather-ship on the 11th (see page 216). In each case the position is marked "X".

It seems clear from these records that a large number of Wheatears, attempting a migratory flight from the Hebrides or Northern Ireland to either Greenland or Iceland, were deflected from their course by the approach of this depression, and were carried down-wind in the easterly airstream of its northern perimeter, some being blown very far west. It is worth noting that wind and sky conditions were excellent all over Scotland, the Hebrides and Northern Ireland on the night of the 7th/8th, but that during the whole period fronts active in the Shetland-Faeroe region brought fog and drizzle to this section of the route. The 3 birds noted by A. P. Ryan on 11th May in the westerly airstream south of the now northwards-moving low may well have travelled all round this depression until brought within striking-distance of western Ireland.

Of the large number of autumn migrants recorded at ships many appear to have been making a cyclonic approach to western Britain, and could be traced back to southern Greenland on a down-wind track. In some instances Snow Buntings (*Plectro-*

*phenax nivalis*) were observed at the same time. Watchers in various weather-ships (F. R. Allison, M. A. Barras-Smith, A. Darlington and M. L. R. Romer) during September 1950 supplied records to *British Birds* (Anon., 1951), all of which fall into this category. There were 2 Wheatears at  $59^{\circ}\text{N}.19^{\circ}\text{W.}$  on 12th September and 9 at  $52^{\circ}\text{N}.20^{\circ}\text{W.}$  next day (Figs. 6 and 7). Birds moving down-wind through this depression could have reached the west and north of Scotland, and it is interesting to note that 8 long-winged birds trapped at Fair Isle between the 12th and the 14th showed a weight-range of 22.3 gm. to 26.7 gm. (average, 25.1 gm.), or about 10 gm. below the expected weight for *leucorrhoa* at this season.

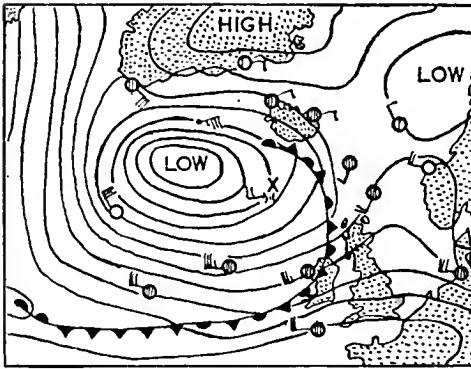

Fig. 6

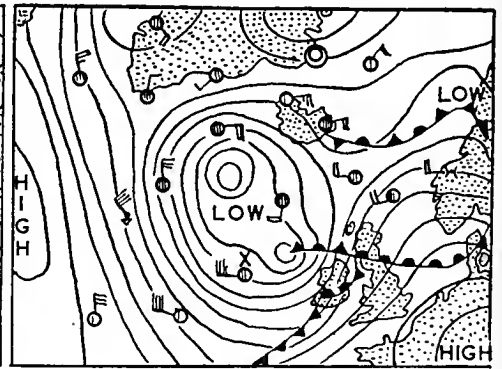

Fig. 7

FIGS. 6 and 7—OCCURRENCES OF WHEATEARS (*Oenanthe oenanthe*) AT SEA. Weather-charts for mid-day on 12th and 13th September 1950, to illustrate the conditions that resulted in the arrival (Fig. 6) of two Wheatears at a weather-ship on 12th September; and (Fig. 7) of nine at a weather-ship on the 13th (see this page). In each case the position is marked "X".

Two Wheatears spent 20 minutes aboard at the same station on 22nd September, and of 9 Snow Buntings seen that day 6 passed the ship flying south singly or in pairs. These appear to have travelled south through a col after leaving Greenland and entered a westerly airstream in the complementary wind-system between a trough in the Iceland-Faeroe seas and an Azores high farther south (8 Snow Buntings were also seen on 29th under similar cyclonic conditions). Two very late Wheatears seen by A. P. Ryan at  $52^{\circ}30'\text{N. } 17^{\circ}20'\text{W.}$  on 21st October, with rain falling and a fresh S.W. wind (Fig. 8), and 3 recorded at  $49^{\circ}22'\text{N. } 34^{\circ}15'\text{W.}$  by Goodwin (1954) on 16th September 1949 (Fig. 9), are other cases of cyclonic migration.

When H.M.S. *Vidal* was returning from the annexation of Rockall on 20th/21st September 1955, and was about half-way between south-west Ireland and Cornwall, a flock of about 24 Wheatears came aboard soon after midnight, very tired (Fisher, 1956). Those handled were *leucorrhoa*, and Fisher suggests they were cyclonic migrants from Greenland. Before 0800 hours the previous

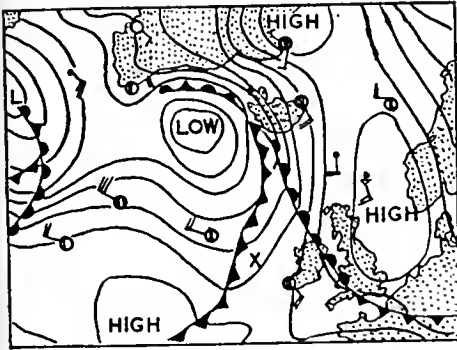

Fig. 8

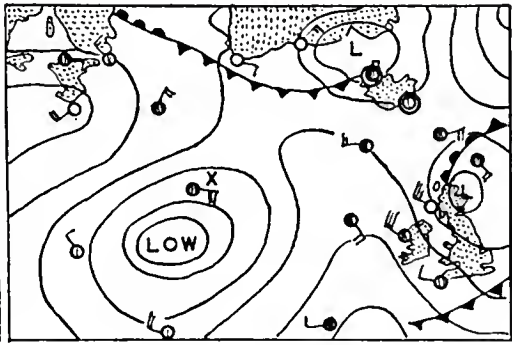

Fig. 9

FIGS. 8 and 9—OCCURRENCES OF WHEATEARS (*Oenanthe oenanthe*) AT SEA. Weather-charts for mid-day on 21st October 1950 and 16th September 1949, to illustrate the conditions that resulted in the arrival (Fig. 8) of two Wheatears at a weather-ship on 21st October 1950; and (Fig. 9) of three at a ship on 16th September 1949 (Goodwin, 1954) see page 218). In each case the position is marked "X".

day 3 *leucorrhoea* at very low weights had been trapped at Fair Isle—2 adult ♀♀ at 21.1 gm. and 20.4 gm. (wings 101 and 103 mm.), and a 1st-winter ♂ at 23.2 gm. (wing 100 mm.). It is apparent from the synoptic situation that these birds were finishing a long approach to Britain round the southern periphery of an eastwards-moving low situated a good way west of the Hebrides, and the distance flown may well have been of the order of 1,800 to 2,000 miles (Fig. 10).

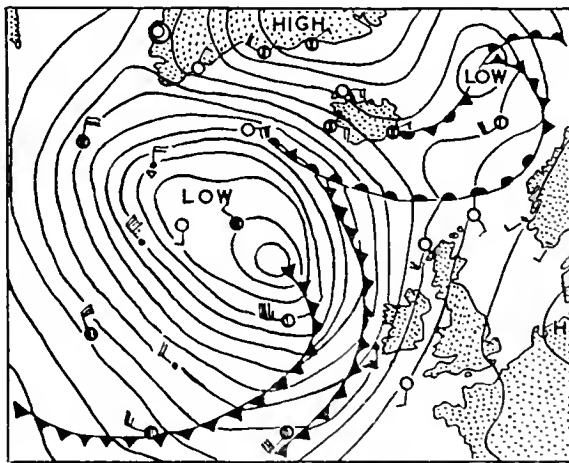

FIG. 10—OCCURRENCE OF WHEATEARS (*Oenanthe oenanthe*) AT SEA. Weather-chart for mid-day on 20th September 1955, to illustrate the conditions on the day before the arrival of two dozen Wheatears on board H.M.S. "Vidal", south of Ireland, on 21st September 1955 (Fisher, 1956) (see page 218).

There is thus abundant evidence in the meteorological correlation of Wheatear records at sea in the North Atlantic, and of movements passing through Fair Isle, of extended cyclonic

journeys, and of the need for a greatly increased capacity in the Greenland and Iceland stocks for the storage of glycogen and fats to withstand the severe drain on their resources caused by long overseas flights. These flights may well be in excess of 1,000 miles in most cases—and much nearer 2,000 miles in some—and may reduce the Greenland Wheatear to a weight which is even less than the normal for the much smaller *oenanthe*. It will be seen from Table III that the range of possible weights for *leucorrhoea* is almost twice as great in comparison with the mean as that of the typical race—implying that the northern population is able to sacrifice a greater proportion of its total body-weight during this hazardous migration without falling below the threshold (the “lebensminimum”) beyond which recovery is impossible.

#### REDWING (*Turdus musicus*)

The Iceland Redwing (*Turdus m. coburni*) breeds at approximately the same latitudes as the bulk of the Scandinavian population of typical *musicus*. The Icelandic race is bigger, the difference being most pronounced in body-weight, and reflected in length of wing and tail: viz., mean wing-length 121.3 mm. and tail-length 85.2 mm. in *coburni*, against 116.6 mm. and 79.9 mm. in *musicus* (Williamson, in press). A substantial difference in body-weight can be demonstrated from the laboratory records of samples trapped when on migration through Fair Isle. In autumn 1956 over 300 birds were weighed and the average difference was 5½ gm. in favour of *coburni*. In previous seasons, with fewer *coburni* trapped, a difference of up to 10 gm. (1954) was noted. The mean weight of a sample taken on any one day varies according to the type of weather and the length of the journey involved, as with the Wheatear, and in 1956 we were dealing largely with *musicus* which had made a short sea-crossing in ridge or col weather from western Norway, and *coburni* which may well have travelled three times that distance as cyclonic migrants. There are only a few weight records for spring migrants, and these suggest a norm for *musicus* of around 70 gm. and for *coburni* of up to 90 gm.—viz., 10th March 1950, 89.2 gm.; 25th April 1950, 91.7 gm.; 6th April 1952, 86.6 gm.

Scandinavian Redwings winter over most of western and southern Europe, including the whole of Britain. The migration of Scandinavian birds is rather “fanned out”, as Holgerson (1953) puts it, so that many reach Italy and the central Mediterranean countries. Recoveries of birds ringed as young in Iceland have been made in winter in Ireland and the Outer Hebrides, and a *coburni* ringed on passage at Fair Isle in October 1955 was found in November 1956 in Co. Kerry. Another autumn migrant, wing 122 mm., ringed during an influx of Iceland Redwings and Merlins on 14th October 1953, was found dead in November near Antwerp, Belgium; and although Molyneux (1930) includes Holland and France in the wintering-range these Continental occurrences may

be merely a slight overspill from the main headquarters in the British Isles.

It could be claimed that since the influence of a warm Mediterranean climate is enjoyed by a large number of Continental Redwings, there is partial allohiemy with the Icelandic race; but it seems hardly likely that selection-pressure due to this spatial separation can be very great, since equally a vast number of *musicus* share with *coburni* a mild Atlantic climate. Furthermore, the Continental race is either peculiarly prone to the vagaries of drift or has an unusually nomadic instinct, since many individuals (perhaps the majority) seem to change their wintering-area from year to year. Thus, birds marked in winter in Gloucestershire (1934), Worcestershire (1937) and Cornwall (1939) were all recovered in the following winters in northern Italy (Leach, 1941); and a bird ringed at Gibraltar Point Bird Observatory, Lincolnshire, on 1st November 1952 was recovered at Kyrenia in Cyprus on 13th February 1955 (Spencer, 1955). I can find only one record of a bird returning to the same winter-quarters in Britain in successive years, at Shrewsbury on 10th February 1947, and 22nd January 1948.

If such wide dispersal over the winter range, with frequent alteration between the Atlantic and Mediterranean types of climate, is in any way usual, then the "winter-influence" in the adaptive variation must be reduced to a minimum and should tend to diminish any gap in size between *musicus* and *coburni*. A study of the meteorological environment of the autumn influxes of Icelandic birds (Williamson, 1953a and in press), shows that the situation in this subspecies is very similar to that in the Greenland Wheatear. "Island-hopping" migration takes place when col and anticyclonic weather affect the direct route via Faeroe and Shetland, but there are frequently longer cyclonic journeys, and since the Redwing is a late autumn migrant the majority of the arrivals belong to this kind because of the rapidly deteriorating weather in the north-east Atlantic in October. There is good cause for believing that at least some movements of *coburni* take place in two stages, culminating in an overseas flight from southern Greenland. This would appear quite clearly to be another case of the north-western population having developed greater body-size as the result of strong selection-pressure due to a mandatory overseas migration.

#### REDPOLL (*Carduelis flammea*)

The redpolls have a holarctic distribution, forming an emergent interspecies which most taxonomists treat as two distinct species and split up into several recognizable forms. They comprise an Arctic group (*hornemanni* and *exilipes*) a sub-Arctic group (*rostrata* and *islandica*, and perhaps also *pallescens*), and a boreal group (*flammea*, and the Lesser Redpolls *disruptis* and *cabaret*). The two Lesser Redpolls are isolated in the wooded country of the

British Isles and the mountain system of south-central Europe respectively, and present no problem. The pale, white-rumped Coues's Redpoll, *exilipes*, inhabits the Arctic scrub of Europe, Asia and North America, and Hornemann's is a larger edition of it in the high Arctic regions of Greenland and Baffin Island. The typical race, the Mealy Redpoll, extends across Europe, Asia and North America as a forest bird south of the range of *exilipes*; the American population, pushing eastwards, has colonized parts of Baffin Island and low Arctic Greenland and become the larger, darker, thick-billed *rostrata*. In years of late spring many *exilipes* breed south of their normal limit and within the range of the Mealy Redpoll, and the white-rumped *palescens* recorded from Arctic Norway is probably a hybrid form. The Iceland bird appears to be an intermediate population in which extreme types are hardly separable from the very pale *hornemanni* on one hand and the dark *rostrata* of southern Greenland on the other. Salomonsen (1951) has shown that, with the amelioration of the climate in southern Greenland, *rostrata* is pushing its range farther north into the breeding zone of Hornemann's Redpoll, and interbreeding occurs where they meet, so that the trend which produces *palescens* in northern Europe is here reversed. Iceland, being within the migratory orbit of both *hornemanni* and *rostrata*, seems to have captured both and welded them into a hybrid population, *islandica*; and with an intermediate form occupying so great an area the recognition of two "species" of redpolls, very similar morphologically and in habits, does violence to taxonomic principles, as Salomonsen has shown (1928, 1951).

The largest race, *hornemanni*, and the isolated forms inhabiting Britain and the alpine region of southern Europe are only partially migratory and do not move far: they are not considered further in this discussion, except to say that Hornemann's Redpoll returns to the breeding-area from its low Arctic wintering-grounds some 10 days to a fortnight ahead of the slightly smaller *rostrata* (Salomonsen, 1951; Wynne-Edwards, 1952)—so that in this instance Hemmingsen's rule applies. The extent to which the Icelandic bird migrates is not known: certainly a number stay in Iceland throughout the year, but it is possible that others are numbered among the *rostrata* which reach Britain from southern Greenland in the fall.

This bird and the Mealy Redpoll of northern Europe are the only forms which are in any sense strongly migratory, and they breed at much the same latitudes. The Greenland Redpoll is the bigger bird, Salomonsen (1951) giving these wing-measurements: *rostrata*, ♂♂ 77-83 mm., ♀♀ 75-82 mm.; *flammea*, ♂♂ 71-78 mm., ♀♀ 69-75 mm. The great majority of *rostrata* depart from west Greenland during September to winter in the eastern provinces of Canada, whilst the east-coast population winters for the greater part in Iceland, Scotland and western Ireland. The Mealy Redpoll has only a short overland migration, wintering for



the most part in middle Europe and in some years in fair numbers in the British Isles. For practical purposes the two forms can be regarded as allohiemic; there is little difference in the latitude of the wintering range but it should be emphasized that the larger form enjoys the milder, Atlantic climate, and the smaller Mealy Redpoll is exposed to the colder, Continental one—so that in this case there is an apparent reversal of the expected size-trend.

With 4 exceptions, the 41 weight-records of redpolls obtained at Fair Isle between 1948 and 1955 are of birds identified with *rostrata* on plumage characteristics and their strong, bulging bills. The 4 Mealy Redpolls give from 13.8 to 15 gm., average 14.4 gm.; and Weigold (1926) gives a longer series, 19 examples ranging from 12 to 17.5 gm., average 14.4 gm. He adds a "lebensminimum" of 9.5 gm. for an exhausted bird. These were migrants at Heligoland, so had not travelled far. The 37 records (including recaptures) of *rostrata* at Fair Isle give a range of 10.7 to 21.2 gm., average 16.3 gm. Birds retrapped whilst "off passage" show gains of between 20 and 40 per cent. of their initial arrival weight over periods of from 9 to 17 days, and suggest that the normal weight of this subspecies must be close on 20 gm. (see Table in Williamson, 1956).

Birds have been seen occasionally at sea: 3 *rostrata* flew aboard a ship at 60°N. 23°30'W. on the afternoon of 29th August 1955 in cyclonic weather (R. Meinertzhagen, pers. comm.), and small flocks were noted about 100 miles west of Faeroe in June 1929 (Saemundsson, 1934). The synoptic picture in the north-east Atlantic at the time of their immigration at Fair Isle is frequently indicative of down-wind drift from south-east Greenland in cyclonic airstreams, and several movements of this type were a feature of an unusually large and protracted irruption which took place in 1955 (Williamson, 1953b, 1956). In these respects the migration into Europe affords a close parallel with the other cases considered in this paper, and this is apparently a further instance of selection working through the medium of the migration-flight to produce a greater body-size and longer wing. That the effect is less strongly marked than in the case of the Wheatear and Redwing may be due to the fact that a part of the Greenland community winters in the New World and has only the comparatively narrow Davis Straits to cross.

#### OTHER PASSERINES

The Lapland Bunting (*Calcarius lapponicus*) is predominantly a low Arctic breeder in Greenland. The Snow Bunting is a common summer visitor to the high Arctic as well as low Arctic regions and is the only one to nest in Iceland, where it is differentiated by the name *insulae* on plumage characters. In Greenland, according to Salomonsen (1950-51), both species seek the warmer and drier anticyclonic climate of the interior fjord country and are relatively scarce in the less benign coastal regions.

Greenland Snow Buntings cannot be separated from the populations of Canada and Europe: birds from north-west Greenland are slightly longer in the wing ( $\sigma\sigma$ , 107-118 mm.) than European ( $\sigma\sigma$ , 105-115 mm.) but are no bigger than *pallidior* from Siberia. Greenland "Lap" Buntings have been distinguished from the typical race as *subcalcaratus* on account of slight plumage differences coupled with a more robust bill. The wing is a little longer on average, Hörring (1937) giving for 52 Greenland  $\sigma\sigma$  91-101 mm., and for 20 European  $\sigma\sigma$  90-96 mm. At best, however, *subcalcaratus* is a poorly defined form.

In these two buntings, therefore, there is but little tendency towards a greater size as compared with the corresponding Continental populations, despite the fact that a minor part of the Greenland population (probably from the east coast only) crosses the Atlantic to Europe under weather conditions similar to those already described for the Wheatear, Redwing and Greenland Redpoll. The synoptic background of a phenomenal Lapland Bunting invasion of northern and western Britain in September 1953 was studied by Williamson and Davis (1956), and it was shown that this must have originated in southern Greenland and that several of the movements in that and previous years took place under cyclonic conditions. Ten Snow Bunting recoveries show movement from west Greenland to the eastern provinces of Canada (one to Minnesota, U.S.A.), and a recent record concerns a spring migrant ringed in north-east Greenland in May 1955 and recovered in Archangelsk District of Russia in April 1956. The most recent list also notes the only recorded movement of a ringed Lapland Bunting, from Egedesminde District in the west to the interior of southern Canada. It is highly probable that the bulk of both populations winter in the New World and show little increase in robustness since they have only the short sea-crossing of the Davis Strait to make.

Two other species which are common breeding-birds in Iceland and northern Europe, and which are strongly migratory, are the Meadow Pipit (*Anthus pratensis*) and White Wagtail (*Motacilla a. alba*). The former winters largely in the Mediterranean basin, the latter crossing it to winter in tropical Africa. It is not known if the Icelandic populations are synhiemic with the Continental, but this seems very probable in the case of the wagtail at any rate. These Icelandic populations must make an obligatory overseas flight, and passage at Fair Isle under the same weather conditions as reported for the previous species is probably derived from this source. In neither species does the Icelandic bird differ from the Continental in size, so far as is known.

It is worth while noting that the White Wagtail does not fit into Salomonsen's theory, since it has a "leap-frog" migration over the winter range of the Pied Wagtail (*Motacilla a. yarrellii*)—the British race, some of which cross the Channel to winter in France—to Africa, and ought therefore to be smaller if the

"winter influence" of a tropical environment is strong. It may be that the tropical "winter-influence" is countered in this subspecies by the potential for greater size due to the need to survive a long overseas hop from Iceland to Britain, so that one effect balances the other. However, it should also be borne in mind that the recent spread of both Meadow Pipit and White Wagtail to eastern Greenland suggests that their presence in the north-west may be the result of a comparatively new, and continuing, expansion of range, and that the time-lapse since their arrival has been too brief for subspecific differences to develop.

MERLIN (*Falco columbarius*)

The Icelandic Merlin (*Falco c. subaeson*) breeds between the same latitudes as many *Falco c. aesalon* of Scandinavia and north-west Russia: it is considerably more robust than the Continental race, the mean wing-length of ♂♂ being 209 mm., and of ♀♀ 227 mm., against 197 mm. and 215 mm. respectively for the European bird. The joint non-overlap between the two races is 96 per cent. in ♂♂ and 94 per cent. in ♀♀ (see Table and discussion in Butterfield, 1954). A series of measurements is also given by Salomonsen (1935).

There are some limitations in the use of weight-records for a comparison of the Icelandic and Continental races, since the weight of any individual bird-of-prey may be expected to vary within a fairly wide range. Obviously, a newly-arrived migrant at Fair Isle would register much less than an "off passage" bird which had made a recent kill, especially as the prey is sometimes as big as a Redwing. When all the available weights are averaged, sex for sex, including records of the same individuals if recaptured, it is probable that these inequalities are to some extent reduced. If the figures are comparable, then it would appear that *subaeson* is considerably heavier than *aeson*—viz., 21 ♂♂, 182 gm. and 21 ♀♀, 255 gm., against 9 ♂♂, 175 gm. and 11 ♀♀, 210 gm. Kluz (1943) gives for an unspecified number of *aeson* a range of: ♂♂, 150-180 gm., ♀♀ 188-210 gm., the upper limit in each case being less than the average for *subaeson* at Fair Isle.

The sedentary British population shows a ♂ wing-length close to the mean for Continental birds, but a ♀ wing-length nearer that of Icelandic ♀♀. The Continental race winters over much of Europe south to the Mediterranean, while the Icelandic population spends the off-season mostly in western Britain with (in all likelihood) some slight overspill on the Continent between southern Norway and France. Four recoveries of birds ringed as young in Iceland are known from Eire (Offaly), central and south-west Scotland (Stirlingshire, Dumbartonshire) and north-west England (Lancashire), and there are specimens of this race in museum collections from most Scottish and many English and Irish counties. Icelandic birds ringed on passage at Fair Isle have been recovered

in Caithness and Perthshire, and a ♂ *subaesalon* ringed on 18th August 1953 was found at Hannut, Liege, Belgium, two months later. An interesting capture of an Icelandic Merlin (♂, wing 213 mm.) was made in the North Sea 26 miles east of Spurn Point, Yorkshire, on 12th October 1910 (specimen in the British Museum). Recently Holgersen (1954) has recorded autumn and winter specimens from south-west Norway, and has since added a further record (pers. comm.).

The Icelandic Merlin is therefore synhiemic with the British population, and although it is clear that there is partial allohiemy with the Continental race both forms winter largely in the mild maritime climate of western Europe. It seems doubtful if selection due to factors of either the breeding or the wintering environment can be so markedly different as to have produced the remarkable size discrepancy which we find between these two races, and this would appear to be a clear case in which selection pressure is strongest during the actual migration period; for whereas the southwards movement of *aesalon* is largely overland, that of *subaesalon* must necessarily encompass a sea-crossing of several hundred miles, as a recent synoptic study of the autumn migration has shown (Williamson, 1954b; Williamson and Butterfield, 1955).

Little is known of the spring migration of *subaesalon*: the Merlin is a very scarce bird at Fair Isle in April and May, and perhaps the return is made direct from northern Scotland and the western isles (the species was of daily occurrence at St. Kilda in April and early May of 1957). There are in the Universitetets Zoologiske Museum, Copenhagen, 3 spring specimens taken on board ships in the Atlantic—a ♂ on 22nd May 1949 at 58°45'N., 40°15'W., and a pair on 6th May 1952 at 59°51'N., 36°W. The last are of interest inasmuch as the whole of Britain and southern Norway were under the influence of an active depression during 4th-6th May, and it is possible the birds had tried to reach Iceland from northern Norway and had overshot in the N.E. gale winds blowing in that area. To have reached the position in which they were captured from any part of the British Isles or southern Norway they would have had to combat force 6 northerly winds and rain, an impossible feat.

Recent records of autumn migrants at sea have been discussed by McLean and Williamson (1957), and a bird was seen by Wilkinson (1956) some 400 miles west of Ireland on 2nd October 1955, in the southern segment of a depression giving a cyclonic down-wind track between Iceland and the British Isles. These cases substantially confirm the earlier work on the migration of this species.

#### REDSHANK (*Tringa totanus*)

The Icelandic Redshank (*Tringa t. robusta*) is not only longer in the wing than the typical race, whose range extends to northern Norway, but also has a bigger sternum (Nörrevang, 1954) and

stouter tarsi (Harrison, 1944), indicating a greater body-weight. Salomonsen (1935) gives a maximum wing-length of: ♂♂, 160 mm., ♀♀, 163 mm., for Danish birds, and ♂♂ 171 mm., ♀♀ 172 mm. for Icelandic. Witherby *et al.* (1938-41) give similar maxima for *robusta* but mention British-taken specimens with wings up to 175 mm.: for *britannicus* they give: ♂♂, 163 mm., ♀♀, 165 mm. Harrison (1944) gives for *robusta*, 7 ♂♂, 165-172 mm., 3 ♀♀ 164-177 mm., and for Norwegian birds, 10 ♂♂, 148-158 mm. There is little data on weights: presumed Norwegian birds with a wing-length of 154-156 mm., trapped at Fair Isle in early autumn, weighed 102 gm., 120 gm. and 134 gm.; and birds referred to *robusta* on a wing-length of 163-173 mm. weighed 127 gm., 128 gm., 130 gm. and 148 gm. (an average of 133 gm. against 119 gm. in the first group).

Redshanks ringed in Iceland have been recovered in winter in localities as far apart as Orkney in the north, Flintshire in the west and the Wash in the south-east, so we may take it that the whole of Britain lies within the winter area. According to Witherby *et al.* (1938-41) some *robusta* are recorded in winter along the west coast of Europe, and there is one recovery as far south as Morocco. The same authority says that only a small part of the British stock crosses the Channel, but that some birds from northern localities go to Ireland. The winter ranges of the European populations have been worked out by Salomonsen (1954), who gives maps based on ringing returns. Danish birds make an overland migration to the central Mediterranean countries, whilst those from the Low Countries and west Germany winter in the Iberian Peninsula and North Africa. British and west European Redshanks, though wintering in widely separated areas in the Mediterranean and Atlantic maritime regions, do not differ materially in size, whereas the synhiemic British and Icelandic populations show a difference of 10 mm. in the mean of the wing-measurement. The lowest mean wing-length belongs to Norwegian and Swedish birds, which migrate coastwise through Europe to tropical Africa, and thus enjoy the warmest winter environment.

Although the pattern of allohiemy which dominates the winter distribution of the Continental populations firmly supports Salomonsen's conclusion that there is a correlation between Bergmann's Rule and selection in the winter quarters, it would appear that the more robust proportions of the Icelandic bird are better explained as an adaptation to a mandatory overseas migration.

#### OTHER WADERS

There is a small average difference in wing-length between Continental and Icelandic Whimbrels (*Numenius phaeopus*), and the Iceland bird has been separated despite the existence of a large overlap in this character. Salomonsen (1935) gives for 39 Scandinavian specimens, ♂♂, 231-250 mm., ♀♀, 241-254 mm.,

and for 77 *islandicus*, ♂♂, 240-260 mm., ♀♀, 251-272 mm. Faeroe birds are intermediate, giving for ♂♂, 238-252 mm., and for ♀♀, 245-264 (23 measured). (See also the Table in Salomonsen, 1947.) Both forms breed at roughly the same latitudes and, so far as is known, winter in tropical Africa. There would appear to be little influence towards differentiation in either the breeding or winter climates, and the somewhat longer wing of the Iceland birds probably reflects the need for greater staying-powers during the obligatory overseas journey to and from the breeding-grounds.

Oystercatchers (*Haematopus ostralegus*) of Iceland and the Faeroe Islands are also somewhat longer in the wing than Scandinavian birds, but there is a wide overlap and many taxonomists cannot accept the north-western birds as a distinct race, *malacophaga*. Measurements given by Salomonsen (1935) indicate a maximum wing-length of : ♂♂, 272 mm., ♀♀, 276 mm., for Icelandic birds; ♂♀, 270 mm. for Faeroe breeders; and ♂♂, 263 mm., ♀♀, 265 mm. for Continental. British examples are intermediate. Many Continental Oystercatchers breed at much the same latitudes as the Faeroese and Icelandic stocks, and winter over most of south-west Europe and the Mediterranean region, some on the coast of west Africa; while all recoveries of Iceland and Faeroe (and also Fair Isle) birds are from Scotland, the west of England, Ireland and (a few only) France. A different "winter-influence" may well be involved, derived from Mediterranean and Atlantic climates, and the case for attributing the greater size of the Iceland and Faeroe populations to the overseas migratory flights is less strong in this species.

The wing-length data given by Salomonsen (1950-51) for the Purple Sandpiper (*Calidris maritima*), and reproduced in Table V, show a peculiar distribution, Icelandic birds being distinctly larger than either Greenland or Scandinavian. Lovenskiöld (1950) has also made a detailed examination of this species and presents the measurements of the various populations in histograms. In all probability Icelandic birds are also heavier: Weigold (1926) gives 60-84.5 gm. for 3 migrants at Heligoland, and quotes Hantzsch for Icelandic birds (presumably breeders), 4 ♂♂, 74-80 gm., 5 ♀♀, 80-95 gm. This northern species has a Holarctic range and practically nothing is known about the winter distribution of the various populations. The only recovery of a bird marked in Iceland is a curious one—an adult ringed in May 1942, recovered at Cape Dorset, Baffin Island, in late April 1943. It may be that Iceland and Faeroe Islands have been colonized from the Palaearctic region, the increase in size being a subsequent adaptation to a mandatory overseas migration to Old World wintering quarters; and that the Greenland stock is derived from the North American continent, to which it has access by the short sea-crossing of Davis Strait.

TABLE V—WING MEASUREMENTS OF DIFFERENT POPULATIONS OF PURPLE SANDPIPERS (*Calidris maritima*) (after Salomonsen, 1950-51)

Origin	Males			Females		
	No.	Range (mm.)	Average	No.	Range (mm.)	Average
Iceland	51	123-137	129.1	36	127-141	134.6
Faeroe Islands	10	124-132	127.2	15	125-133	130.1
Scandinavia	30	118-131	124.6	26	125-135	129.8
Greenland	72	117-131	123.7	68	120-137	123.7

The Black-tailed Godwit (*Limosa limosa*) of Iceland is separable from the typical race of Europe on account of its redder plumage in the breeding season and its shorter bill, sex for sex (Salomonsen, 1935). The wing-length range appears to be much the same in the two races, except that ♀♀ *islandica* are perhaps a trifle bigger than Continental. Hachisuka (1927) gives 217-230 mm., and Salomonsen 210-228 mm. for ♀♀ *islandica*, the latter adding 209-225 mm. for Danish *limosa*. Except for a small group in S. Sweden (and isolated instances in Norway), the Black-tailed Godwit does not nest on the Continent north of the Kattegat and Skagerrak, so there is a considerable latitude difference in the breeding-ranges of the two forms. It is now known that a large part of the winter population of Black-tailed Godwits in Ireland consists of *islandica* (Williamson and Ruttledge, 1957), so that, since many *limosa* winter southwards to tropical Africa, *islandica* ought to reflect Bergmann's Rule on both counts. Since it obeys Allen's Rule of decreasing bill-size with increasing latitude, it has presumably been established in Iceland for a very long time, and its lack of greater robustness despite more northerly breeding and wintering areas, and an obligatory overseas migration, makes it a puzzling case.

As with the Merlin, little is known about the spring migration: its rarity in the Outer Hebrides and northern Scotland suggests that the main movement avoids these areas, though the sporadic breeding of pairs possibly belonging to this form in Caithness (Pilkington, 1947), Shetland (Venables and Venables, 1955) and Faeroe (Williamson, 1954a) should be noted. Holgersen and Willgohs (1956) have recorded the interesting and perhaps significant fact that Black-tailed Godwits are more frequent in Norway in spring than in autumn, and that all Norwegian specimens so far examined have the short bill-length of *islandica*. It is possible therefore that a proportion may return to Iceland by way of the Norwegian coast.

Finally, the White-fronted Goose (*Anser albifrons*) may be mentioned. The Greenland form *flavirostris* winters exclusively in Ireland and south-west Scotland, as the numerous recoveries of ringed birds show. The flocks reach these areas in middle and late October largely by a cyclonic migration across the eastern Atlantic (Ruttledge and Williamson, 1952). Salomonsen (1950-51) gives wing-measurements of 368-440 mm. for typical *albifrons* of

Europe, which has a largely overland migration to winter quarters at much the same latitude in western Europe, and 420-455 mm. for *flavirostris*. This follows the pattern demonstrated for the majority of these trans-oceanic migrants from Greenland and Iceland to winter quarters in western Europe and beyond.

#### ACKNOWLEDGEMENTS

I am grateful to Dr. D. W. Snow and Messrs. E. F. Aikman and A. P. Ryan for making available information concerning Wheatears at sea; and to Mr. Alec Butterfield for undertaking a statistical examination of Wheatear weights. Recoveries of birds ringed in Iceland have been taken from the reports issued by Gudmundsson (1933 *et seq.*), and those of Greenland birds from the reports of Salomonsen (1949 *et seq.*). Weather-maps are reproduced from the *Daily Weather Report* of the Meteorological Office (Air Ministry) by kind permission of H.M. Stationery Office.

#### SUMMARY

1. The selective influences which contribute to the effect known as Bergmann's Rule are briefly discussed in so far as they concern migratory birds. A correlation between wing-length and the minimum temperature of the winter environment has been demonstrated for some migratory species with allohiemic populations, but there are cases of agreement with this ecogeographical rule which neither this nor any other reason so far advanced can satisfactorily explain.

2. The proposition is made that among certain land-birds whose migration demands an obligatory over-seas flight, selection operates most powerfully during the actual period of migration, since survival favours those individuals with the greatest reserves of strength. In the case of a number of migratory birds nesting in Greenland and Iceland the resulting adaptation has been one of greater body-weight, coupled with an allometric increase in length of wing and tail, as compared with the appropriate Continental populations, whose migration is largely coastwise or overland.

3. Among Greenland birds the evolutionary consequence is most strikingly manifested in the Wheatear, which migrates through W. Europe to Africa. The migration-pattern at Fair Isle, and occurrences in the North Atlantic, show that trans-oceanic flights of 1,500-2,000 miles may be undertaken in cyclonic weather, resulting in a weight-loss considerably greater than the typical race could endure. The Greenland Redpoll shows this "migration-influence" less strongly, the Lapland Bunting slightly, and the Snow Bunting hardly at all. In these cases the bulk of the population crosses the comparatively narrow Davis Strait to wintering-grounds in North America, and the need to evolve greater body-size has been less urgent.

4. Among Icelandic birds the effect is most strongly marked in the Redwing, Merlin and Redshank, whose migratory flights





Knut Ellström and Jonas Svensk

ADULT MALE GOSHAWK (*Accipiter gentilis*) AND PREY: HÄLSINGLAND, SWEDEN, APRIL, 1956  
 Note the whitish under-parts closely barred with dark brown, and the grey-tinged brown back and wings, while comparison with the Hooded Crow (*Corvus corone cornix*) which the bird is holding indicates the size. As with many birds of prey, male Goshawks are smaller than females, but here one can see how much larger even the males are than female Sparrowhawks (*F. nisus*), which they closely resemble in plumage except for their more conspicuous eye-stripes (see page 234).



*Kurt Ellstrom and Jonas Svensk*

MALE GOSHAWK (*Accipiter gentilis*) AT NEST: SWEDEN, 26TH JUNE 1953  
The eye-stripe is over-emphasized here by the dark shadow on the face (*cf.* below), but one can see that the banding on the tail is less conspicuous than in the juvenile (plate 39 lower). Here the young had left the nest, but the adults continued to bring food for them there for some time.



*Kurt Ellstrom and Jonas Svensk*

FEMALE GOSHAWK (*Accipiter gentilis*) AT NEST: SWEDEN, 25TH MAY 1953  
The pure white under tail-coverts, which are spread very prominently in the spring display-flights, are particularly well shown here, as is the eye-stripe. Typical clutches consist of three or four eggs, which in Denmark and Sweden are laid in late March and April.



Kurt Ellstrom and Jonas Svensk

YOUNG GOSHAWKS (*Accipiter gentilis*) IN NEST: SWEDEN, 21ST JUNE 1953. At first the male brings all the food and the female divides it up, but later both sexes hunt. Incubation and fledging last about five and six weeks respectively. In this brood the bird on the left, a male, is older (note the feathering of the "trousers") than the other two, both females.



Kurt Ellstrom and Jonas Svensk

JUVENILE FEMALE GOSHAWK (*Accipiter gentilis*): SWEDEN, SEPTEMBER 1955. Note the broad bands on the juvenile's tail (cf. plate 38 upper). Goshawks hunt mainly in woodland and, in addition to a wide variety of birds, kill many mammals, particularly Red Squirrels (*Sciurus vulgaris*), one of which is shown here on the "chopping-block" (see page 235).



Kurt Ellstrom and Jonas Svenske

JUVENILE FEMALE GOSHAWK (*Accipiter gentilis*): HÄLSINGLAND, SWEDEN, SEPTEMBER 1955  
The juvenile is paler above and the feathers are tipped with rufous, while the warm buff under-parts are marked with brown drop-shaped streaks, shown clearly here; these are retained throughout the first winter and are a distinction from the Sparrowhawk (*A. nisus*) which is always more or less barred. Here, and in plates 37 and 39, is illustrated the bird's habit of eating its prey—in this case a Jay (*Garrulus glandarius*), a common food item (see page 236)—in an open area where an all-round watch is possible.

into the British area may exceed 1,000 miles under cyclonic conditions. The Meadow Pipit and White Wagtail give a negative result, but may be comparatively recent and still expanding colonists in the north-west. The Whimbrel and Purple Sandpiper show some response to the selective influence of a mandatory overseas migration, and the Oystercatcher perhaps does so, but the Black-tailed Godwit does not and indeed provides a puzzling exception to Bergmann's Rule.

## REFERENCES

- ANON. (1951): "Migrants observed from ocean weather-ships, July-October 1950". *Brit. Birds*, xlv: 219-222.
- BANNERMAN, D. A. (1919): "List of the birds of the Canary Islands, with detailed reference to migratory species and accidental visitors". *Ibis* (1919): 84-131, 291-321.
- BUTTERFIELD, A. (1954): "*Falco columbarius subaeson* Brehm: a valid race". *Brit. Birds*, xlvii: 342-347.
- FISHER, J. (1956): *Rockall*. London.
- GOODWIN, C. E. (1954): "Wheatears in mid-Atlantic". *Brit. Birds*, xlvii: 85-86.
- GUÐMUNDSSON, F. (1933—): *Skýrsla um Fuglamerkinger Natturugripasafnsins*. Reykjavík.
- HACHISUKA, M. U. (1927): *A Handbook of the Birds of Iceland*. London.
- HARRISON, J. M. (1944): "Some remarks upon the western Palaearctic races of *Tringa totanus* (Linnaeus)". *Ibis* (1944): 493-503.
- HEMMINGSEN, A. M. (1951): "Observations on birds in north-eastern China, especially the migration at Pei-tai-Ho Beach: I, General part". *Spolia Zool. Mus. Hauniensis*, 11, pp. 1-227.
- HOLGERSEN, H. (1953): "Trostetrek". *Stavanger Mus. Arbok*, 1953: 91-102.
- (1954): "Islandsdvergalk". *Stavanger Mus. Arbok*, 1954: 47-50.
- and WILLGOHS, J. F. (1956): "First breeding of the Black-tailed Godwit *Limosa limosa* (L.) in Norway". *Astarte*, 13: 1-8.
- HÖRRING, R. (1937): *Report of the Fifth Thule Expedition*, 2 (6), 122.
- HUXLEY, J. (1942): *Evolution: the Modern Synthesis*. London.
- KLUZ, Z. (1943): "Ornithologicke Tabulky". *Ochrana Rostlin*, 18: 1-72.
- LEACH, E. P. (1941): "Redwings wintering in widely separated areas in successive years". *Brit. Birds*, xxxiv: 243.
- LÖVENSKIÖLD, H. L. (1950): "Den geografiske variasjon hos Fjaereplytten (*Calidris maritima* (Brunn.))". *Dansk. Orn. Foren. Tidss.*, 44: 161-167.
- MCLEAN, I., and WILLIAMSON, K. (1957): Migrants at North Atlantic weather-ships in 1956". *Marine Observer*, 27: 152-156.
- MAYR, E. (1956): "Geographical character gradients and climatic adaptation". *Evolution*, 10: 105-108.
- MOLYNEUX, H. G. K. (1930): *A catalogue of birds, giving their distribution in the western portion of the Palaearctic region*. Eastbourne.
- NÖRREVANG, A. (1954): "Brystebensmal som hjælp ved bestemmelse af Islandsk Rødben (*Tringa totanus robusta* (Schiøler))". *Dansk Orn. Foren. Tidss.*, 48: 235-236.
- PILKINGTON, A. D. (1947): "Black-tailed Godwit breeding in Caithness". *Brit. Birds*, xl: 57-58 (plate 9).
- RENSCH, B. (1939): "Klimatische Auslese von Grössenvarianten". *Arch. f. Naturgesch.* 8: 89-129.
- RUTTLEDGE, R. F. and WILLIAMSON, K. (1952): "Early arrival of White-fronted Geese in Ireland". *Irish Nat. Jour.*, 10: 263-264.

- SAEMUNDSSON, B. (1934): "Zoologiske meddelelser fra Island, XVI". *Videnskab. Medd. fra Dansk Naturhist. Forening*, 97: 35-37.
- SALOMONSEN, F. (1928): "Bemerkungen über die Verbreitung der *Carduelis linaria* Gruppe und ihre Variationen". *Videnskab. Medd. fra Dansk Naturhist. Forening*, 86: 123-202.
- (1935): "Aves". Part LXIV, *Zoology of the Faeroes*. Copenhagen.
- (1947): "Den geografiske Variation hos Lille Regnspove (*Numenius phaeopus* (L)) i Europa". *Dansk Orn. Foren. Tidss.*, 41: 143-145.
- (1949): "Preliminary lists of recoveries of birds ringed in Greenland". *Dansk Orn. Foren. Tidss.*, 43: 251-255; 44: 168-170; 46: 110-117; 49: 130-135; 51: 33-39.
- (1950-51): *Grönlands Fugle (The Birds of Greenland)*. Copenhagen.
- (1954): "The migration of the European Redshanks (*Tringa totanus* (L.))". *Dansk Orn. Foren. Tidss.*, 48: 94-122.
- (1955): "The evolutionary significance of bird-migration". *Dan. Biol. Medd.*, 22 (6): 1-62.
- SCHOLANDER, P. F. (1955): "Evolution of climatic adaptations in homeotherms". *Evolution*, 9: 15-26.
- SNOW, D. W. (1953): "The migration of the Greenland Wheatear". *Ibis*, 95: 376-378.
- SPENCER, R. (1955): "Report on bird-ringing for 1954". *Brit. Birds*, xlviii: 461-498.
- TICEHURST, C. B. (1909): "The Greenland Wheatear". *Brit. Birds*, ii: 271-273.
- VENABLES, L. S. V. and VENABLES, U. M. (1955): *Birds and mammals of Shetland*. Edinburgh.
- WEIGOLD, H. (1926): "Masse, Gewichte und Zug nach Alter und Geschlecht bei Helgolander Zugvögeln". *Biol. Anstalt auf Helgoland*, 17: 1-74.
- WILKINSON, D. H. (1956): "Merlin in the North Atlantic". *Brit. Birds*, xlix: 501-502.
- WILLIAMSON, K. (1953a): "Redwing immigration in autumn at Fair Isle". *Bull. B.O.C.*, 73: 18-23.
- (1953b): "Migration into Britain from the north-west, autumn 1952". *Scot. Nat.*, 65: 65-94.
- (1954a): "Beretning om nogle faerøske ynglefugle". *Dansk Orn. Foren. Tidss.*, 48: 139-149.
- (1954b): "The migration of the Iceland Merlin". *Brit. Birds*, 47: 434-441.
- (1956): "The autumn immigration of the Greenland Redpoll (*Carduelis flammea rostrata* (Coues)) into Scotland". *Dansk Orn. Foren. Tidss.*, 50: 125-133.
- (in press): "Autumn immigration of Continental and Icelandic Redwings".
- and BUTTERFIELD, A. (1955): "Merlin migration at Fair Isle in 1954". *Bull. F.I.B.O.*, 2: 264-268.
- and DAVIS, P. (1956): "The autumn 1953 invasion of Lapland Buntings and its source". *Brit. Birds*, xlix: 6-25.
- and RUTTLEDGE, R. F. (1957): "Icelandic Black-tailed Godwits wintering in Ireland". *Brit. Birds*, 1: 524-526.
- WITHERBY, H. F. *et al.* (1938-41): *The Handbook of British Birds*. Vols. 1, IV. London.
- WYNNE-EDWARDS, V. C. (1952): "Zoology of the Baird Expedition (1950). 1. The birds observed in central and south-east Baffin Island". *Auk*, 69: 353-391.

# PHOTOGRAPHIC STUDIES OF SOME LESS FAMILIAR BIRDS

## LXXXIX. GOSHAWK

Photographed by KURT ELLSTRÖM and JONAS SVENSK

(Plates 37-40)

Text by I. C. T. NISBET

THE GOSHAWK (*Accipiter gentilis*) is of special interest as one of the very few birds of prey which occur on both sides of the Atlantic. It belongs to an extensive group of species of "goshawks" (formerly placed in a separate genus *Astur*, but now merged with the sparrowhawks in *Accipiter*), which has an almost ubiquitous distribution in the Old World, with many species in Africa, southern Asia, the East Indies and Australia. The European Goshawk is the most northerly and the most widespread of all, and is the only member of the group which is found in North America—in this resembling the northernmost species of other genera of birds of prey, such as the Golden Eagle (*Aquila chrysaetos*) and the Hen Harrier (*Circus cyaneus*). It breeds from coast to coast in both continents, extending north of the Arctic Circle wherever there are suitable woodlands, and south to the Mediterranean, southern Russia, Japan and the northern United States, with other populations in the mountains south to Morocco, Tibet and New Mexico. Despite its wide distribution in Europe, however, it is little more than a vagrant to Britain, its recent attempts to establish itself in southern England having met with very limited success (Meinertzhagen, 1950; Hollom, 1957). Like that of many other birds of prey, its past status here is confused and badly documented. It is now best known as a scarce visitor outside the breeding season, and as such has become much more frequent in recent years, especially in south-east England, where in some counties a few are now seen almost every year.

Largely a resident species, the Goshawk has split into a number of subspecies, which differ rather widely in colour. The two races most likely to occur in Britain, *A. g. gallinarum* of west and central Europe and *A. g. gentilis* of Scandinavia, are both brown above, like female Sparrowhawks (*A. nisus*), but adults from south Europe are more slate-grey on the upper-parts, and those from Asia vary from brown through a number of shades of grey. There is also much variation in the colour of the under-parts, and the race *A. g. albidus* of N. E. Siberia is pure white, resembling the celebrated white goshawks of Australia (*A. novaehollandiae*). The American race, *A. g. atricapillus*, is particularly well-marked, the adult having blue-grey upper-parts, an almost black crown contrasting with a wide white eye-stripe, and under-parts with greatly reduced barring, but although this plumage is unlike that

of any west European race, field-identification of vagrants here may not be reliable (*cf. antea*, vol. L, pp. 164-166).

The European races are rather strictly resident—at Falsterbo, the famous hawk migration station in south Sweden, for example, this is one of the rarest of all birds of prey (Rudebeck, 1950)—but other races wander a good deal in autumn and winter, and the northern birds undertake fairly extensive southward migrations. The American race, indeed, is an irruption bird, occasionally invading the United States in large numbers in late autumn, and this tendency to wander is reflected in the occasional appearance of vagrants in Europe: in Ireland this race has occurred more often than the European races. It is interesting to note in this connection that each of the three twentieth-century records of the American race in Europe, mentioned in *The Handbook*, took place in one of the winters listed as invasion years by Bent (1937) and Broun (1945).

The photographs give an excellent impression of the appearance of the species, the closely barred under-parts (plates 37 and 38), the banded tail (plate 38 upper) and the uniform dark brown upper-parts of the adults of both sexes forming a pattern closely similar to that of the female Sparrowhawk, a resemblance which is heightened in flight by the similar long tail and short, rounded wings. The Sparrowhawk is in fact the only species likely to be mistaken for a Goshawk in Great Britain, but the latter is a much larger bird—as illustrated by plate 37, which shows a male with a dead Hooded Crow (*Corvus corone cornix*)—and can often be identified by size alone. However the females of both species are considerably larger than the males, and some female Sparrowhawks look sufficiently similar to male Goshawks to call for much care in identification, especially if no other species is present to give a reliable comparative estimate of size. In these circumstances the only conclusive plumage feature of the adults is the white eye-stripe (plates 37 and 38), which is very hard to see in flight except at close range, but the immatures are very different from any plumage of the Sparrowhawk in their unbarred under-parts with large drop-like streaks, a feature which is admirably shown on plate 40 and which can often be seen in a good view in the field. However, despite the dearth of positive field-marks, the beginner faced with his first Goshawk rarely has any doubt in recognizing it as an unfamiliar species, for in flight it really appears very different from the Sparrowhawk. The wing seems broader-based and heavier, and except when the bird is soaring or in rapid turns the primaries are rarely spread, so that it normally looks more or less pointed—a distinction illustrated by Tinbergen in *The Handbook*, but shown more clearly by the sketches of Holstein (1942) and Hagen (1952). Even more striking, the flight is much more active and manoeuvrable than a Sparrowhawk's, with a characteristically flexible wing-action, so that, as Tucker pointed out in *The Handbook*, the bird often looks more like a gigantic falcon than an *Accipiter*.



The Goshawk is a woodland species and, although a few wander into open country outside the breeding season, it is very easy to overlook. It hunts in the same manner as a Sparrowhawk, pursuing its prey in flight and threading its way through the trees with great dexterity, while in places where the undergrowth is too thick to follow mammals in flight it has even been known to pursue and catch them on foot (Bent, 1937). The prey is usually carried to a clearing or to an open space at the edge of the wood where the bird has a clear all-round view while eating, and plates 39 lower and 40 illustrate a characteristic habit of the species in choosing a tree-stump or similar elevation as a "chopping-block" on which to dismember the prey. Much interesting information on the feeding habits of the species has been given by Tinbergen (1937, 1955). Plates 38 and 39 upper show a typical site for the nest, usually at least thirty feet up in a tree, and normally built by the birds themselves, although nests of buzzards (*Buteo* spp.) and other species are occasionally adopted. The breeding of the Goshawk has been studied and described in great detail by Holstein (1942), and no-one interested in the species should fail to read this fine monograph, nor the more recent book by Kramer (1955), based on observations in Germany.

The Goshawk has long been used for hawking, and accounts in the falconry literature of its training and prowess possess a very respectable antiquity—see, for example, *The Boke of St. Albans* (Berners, 1486). Indeed it shares with the Sparrowhawk the distinction of being the subject of the first ornithological monograph ever written (Anon, 1575), while more than three centuries earlier the Emperor Frederick II had at least planned a similar book on the short-winged hawks, as a complement to his famous text-book of falconry (Wood and Fyfe, 1943). In the Middle Ages, when the more exciting sport of hunting with falcons was reserved to the nobility, the Goshawk was the bird of the yeoman, and in England it has always been used primarily for hunting Partridges (*Perdix perdix*), Pheasants (*Phasianus colchicus*) and Rabbits (*Oryctolagus cuniculus*), while good birds regularly kill hares (*Lepus* spp.). As illustration of the abilities of well-trained Goshawks, Bert (1619) describes a bird that killed eight to ten Partridges each day on the Sussex Downs ("to the great woonder of the worthy Knights and Gentlemen in those parts"), and Harting (1898) mentions a French bird which caught 600 Rabbits in two seasons, while one of Lord Lilford's Goshawks killed 300 Rabbits in three months (Trevor-Battye, 1903). However, the reputation of the species as a mere "kitchen-hawk" (Schlegel and Wulverhorst, 1844-1853) is not entirely deserved, for it can be trained to yield most exciting sport. According to the *Baz-nama-yi Nasiri*, a Persian treatise translated by Philpott (1908), and to Burton (1852), for example, Goshawks were regularly used in Persia and India for hunting such large game as cranes (*Grus* sp.), Great and Houbara Bustards (*O. tarda* and *Chlamy-*

*dotis undulata*) and Gazelles (*Gazella subgutterosa*). The killing of the latter, which Burton describes in graphic fashion, was a feat unexcelled in eastern falconry.

The Goshawk has often been regarded as one of the game-preserver's worst enemies, and its food has been extensively studied. Of 407 prey-items analysed by Hagen (1952) in Norway, 101 were mammals, including 35 Red Squirrels (*Sciurus vulgaris*) and 25 Hares (*Lepus timidus*), and the remainder birds, including 21 Corvidae of various species, 64 thrushes (*Turdus* spp.), 110 grouse (*Lyrurus*, *Tetrao* and *Lagopus*), 35 Pheasants and 13 chickens. The prey shown in plates 37, 39 lower and 40, respectively a Hooded Crow, a Red Squirrel and a Jay (*Garrulus glandarius*), are thus typical of the food of the species in Scandinavia, but widely different preferences have been recorded in other parts of the world. Holstein (1942) mentions birds which specialized in domestic pigeons (*Columba livia*) or Black-headed Gulls (*Larus ridibundus*); the birds in southern England (Meinertzhagen, 1950) lived mainly on Woodpigeons (*C. palumbus*); those in Siberia and Alaska feed extensively on lemmings (*Lemmus* sp.) and Ptarmigan (*Lagopus mutus*), while the American authorities quoted by Bent variously record preferences for duck, chickens, rabbits, Red Squirrels and (formerly) Passenger Pigeons (*Ectopistes migratorius*). In the breeding season birds as small as Chaffinches (*Fringilla coelebs*) and sparrows (*Melospiza*) are sometimes eaten, but in winter, when the females hunt for themselves, the food taken is generally larger, and birds up to the size of Capercaillie (*Tetrao urogallus*) are regularly killed. It often hunts smaller birds of prey; indeed in Holland—where, with relaxation of persecution, the Goshawk has recently increased, even spreading into town parks—Tinbergen (1955) has attributed the corresponding decrease of the Sparrowhawk to the deprivations of its larger cousin. On the other side of the scale, a Goshawk has once been found in a Golden Eagle's nest (Bent, 1937), and Jays sometimes steal the eggs, but the species has only one serious enemy—Man, in his rôles of falconer, game-preserver, chicken farmer and "sportsman". The Goshawk is a wily bird, and there are several cases on record where campaigns to exterminate it have resulted merely in the destruction of harmless species such as Common or Red-tailed Buzzards (*Buteo buteo* or *B. jamaicensis*) or Ospreys (*Pandion haliaëtus*), but it is unlikely that this fine bird will ever become established in Great Britain while present methods of game-preservation are practised.

#### REFERENCES

- ANON. (ca. 1575): *A perfect booke for keepinge of Sparhawkes or Goshawkes*. Edited J. E. Harting, London, 1886.
- BENT, A. C. (1937): *Life-Histories of North American Birds of Prey, Order Falconiformes (Part I)*. Washington.

- BERNERS, J. (1486): *The Treatyses pertyninge to Hawkyngge, Huntyngge and Fysshyngge with an Angle*. St. Albans.
- BERT, E. (1619): *An Approved Treatise of Hawkes and Hawking*. London.
- BROUN, M. (1945): *Hawks Aloft: the Story of Hawk Mountain*. New York.
- BURTON, R. F. (1852): *Falconry in the Valley of the Indus*. London.
- HAGEN, Y. (1952): *Rovfuglene og Viltpleien*. Oslo.
- HARTING, J. E. (1898): *Hints on the Management of Hawks*. London.
- HOLLOM, P. A. D. (1957): "Goshawk", in "The rarer birds of prey: their present status in the British Isles". *Brit. Birds*, L: 135-136.
- HOLSTEIN, V. (1942): *Duehøgen*. Biol. Studier over Danske Rovfugle I. Copenhagen.
- KRAMER, V. (1955): *Habicht und Sperber*. Wittenberg Lutherstadt.
- MEINERTZLAGEN, R. (1950): "The Goshawk in Great Britain". *Bull. B.O.C.*, 70: 46-49.
- PHILPOTT, D. C. (1908): *The Baz-nama-yi Nasiri: a Persian Treatise on Falconry*. London.
- RUDEBECK, G. (1950): "Studies on bird migration, based on field studies in southern Sweden". *Vår Fågelvärld*, Suppl. 1. Lund, Sweden.
- SCHLEGEL, H., and WULVERHORST, A. H. VERSTER DE (1844-1853): *Traité de Fauconnerie*. Leiden & Düsseldorf.
- TINBERGEN, L. (1955): *Levende Natuur*, 58: 211-216.
- , and TINBERGEN, N. (1932): "Waarnemingen aan roofvogels en uilen". *Levende Natuur*, 36: 69-80, 98-104, 131-137.
- TREVOR-BATTYE, A. (1903): *Lord Lilford on Birds*. London.
- WITHERBY, H. F. et al. (1938-1941): *The Handbook of British Birds*. Vol. III. London.
- WOOD, C. A. and FYFE, F. M. (1943): *The Art of Falconry, being the De arte venandi cum avibus of the Emperor Frederick II of Hohenstaufen*. Stanford, California.

## OBITUARY

JOHN ARTHINGTON WALPOLE-BOND (1878-1958)

ON 13TH JANUARY 1958, John Walpole-Bond died at his home in Hove, Sussex, in his 80th year. Educated at Winchester and St. John's College, Oxford, Jock Bond, as he was known to his many friends, was a descendant of Prime Minister Walpole and was the son of a former Vicar of Horsham.

Birds, and particularly their breeding habits, were throughout his long life his one abiding passion. In his later years scarcely a day passed but someone would write to him or ring him up to draw from his vast fund of knowledge, acquired by a life-time of close and intimate study of birds in the field. He claimed to have seen *in situ* the eggs of every regular breeding bird on the British list and, as an oologist, he had at one time a very comprehensive collection.

The earlier years of his life were spent in Kent, and he wrote a book on *The Birds of Bromley (Kent) and its Neighbourhood* (1907). Later he moved to Wales where he spent what he considered the happiest years of his life. *Bird Life in Wild Wales* (1904) was the result of his sojourn in the Principality, and *Field-Studies of Some Rarer British Birds* (1914) was also mainly a product of this period.

But the greater part of his life was spent in Sussex; and it was from his home in Hove that he would emerge every single day in spring and summer to travel immense distances, mostly on his bicycle and on foot until he knew intimately every inch of the county and, it seemed, exactly where every regular breeding species was to be found.

I knew him only for the last 10 years of his life, but I learnt more about birds from him in that time than in the whole of my life previously. It was an education to go out with him: whichever species one wanted to see breeding he would know the precise date on which to look for it and exactly the place to go. He rarely had to refer to a map, but would direct one with unerring accuracy and by the shortest route. He had an encyclopaedic memory and throughout the journey would be continually pointing out sites where different species were to be found. It was in 1938, after 30 years' work on it, that he at last produced his *magnum opus*, *A History of Sussex Birds*, in three volumes.

Besides being blessed with immense strength and with exceptional eyesight and hearing, Bond was an amazingly fit man. He always, till he was nearly 80, took a cold bath and did his morning exercises. He carried not an ounce of superfluous flesh and, to within a year or so of his death, would walk immense distances without apparent effort, losing no opportunity of going over a cliff or climbing a tree, however difficult. A friend of mine, himself a very fine tree-climber, once confessed to Jock that he had been beaten in his efforts to get to a nest perched on the end of an overhanging branch. "The Master" demanded to be shown the spot and, having sized up the situation, he proceeded, though over 70 years old at the time, to walk straight up and out on to the branch without rope, climbing irons or anything.

He was an exceptional cragsman, quite fearless and with a wonderful head for heights. I have vivid memories of him striding along on the very brink of the Sussex cliffs and, in a high wind, stopping every now and again to perch himself on the tip of a promontory in order to lean right over and clap his hands in an effort to put out a Peregrine. (I need hardly say that he knew every ledge and hole between Brighton and Hastings which had ever in living memory been occupied by a Peregrine.)

In his younger days he was a very handsome man, with a magnificent figure. But when I knew him he was, to my mind, the very embodiment of an Old Testament prophet, with his long mane, flashing eyes and magnificent rufous moustache; and the similarity was heightened if, as often happened, he had cut himself while shaving and had staunched the flow of blood with the help of several long wisps of cotton wool.

Ornithologists in the field are not, as a race, noted for sartorial perfection; but Jock's get-up had to be seen to be believed. He never (except in mixed company) sported a tie or collar, but he

would start the day wearing anything from three to six extremely dilapidated pullovers. These would be peeled off one by one as the day progressed, but never was the disreputable old mackintosh which surmounted them discarded. He took a fiendish delight in accosting all and sundry (preferably a rather prim-looking lady) on the flimsiest of pretexts. Watched from a respectable distance by the rest of the company, he would boldly approach his victim and, with a courtly bow, would sweep the ground with his ancient cap. The look of amazement and relief on the face of the lady when there emanated from the lips of this ghastly old "tramp" a flow of impeccable English, beautifully enunciated, was a source of unending amusement to his entourage. He boasted that on two occasions he had been offered his fare on a bus by a kind-hearted old lady; and on one notable occasion he was tipped a florin by a dear old girl and told to buy himself a square meal.

Jock was an extremely generous man: callers were always made welcome and, whenever his means allowed it, lavishly entertained. He was particularly fond of children and, whenever he called at a house where they were present, he invariably presented each one with a piece of money before leaving. He will always be remembered with gratitude by those who were privileged to know him and profit from his great wisdom, which he was ever most willing to share.

A.G.W.

## NOTES

**The identification of White-headed and Ruddy Ducks.**—In the "Recent reports and news" section in our March number (*antea*, p. 132), brief mention was made of the fact that a number of North American Ruddy Ducks (*Oxyura jamaicensis*) had escaped from the Wildfowl Trust collection at Slimbridge, Gloucestershire, in the last year or two; several of these had been reported from various parts of the British Isles, and the possibility of confusing the females and juveniles with the corresponding plumages of the European "stiff-tail", the White-headed Duck (*O. leucocephala*), was pointed out. Since there have been still further reports of these birds and since, as already mentioned, female Ruddy Ducks have been mistaken for female White-headed Ducks on at least three occasions in recent months, as a result of the fact that the latter species is the only member of this genus to be illustrated in books on European birds, we feel that the subject deserves amplification. To illustrate the distinctions between the two females, Mr. Peter Scott has kindly drawn the sketches that are reproduced on the next page.

Both species are quite small ducks and, like the other members of this genus, are characterized by their stiff, pointed tails which are often cocked right up and give their owners such a distinctive shape. The two males are, of course, easily separated: the drake

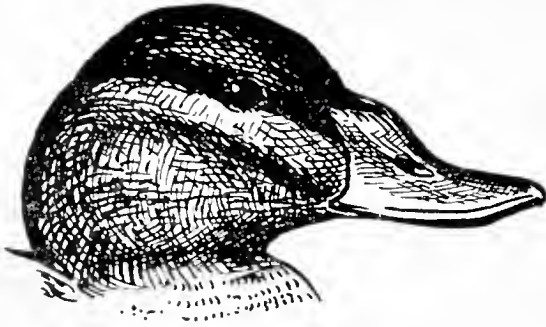

♀ White-headed Duck  
(*Oxyura leucocephala*)

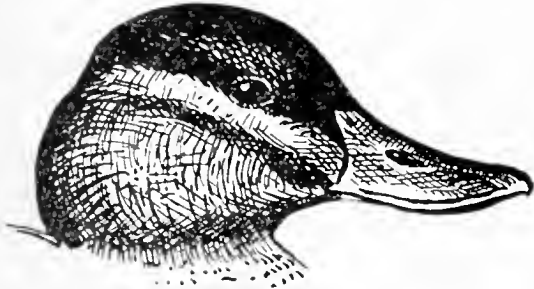

♀ Ruddy Duck  
(*Oxyura jamaicensis*)

HEADS OF THE FEMALES OF THE TWO "STIFF-TAILS" (*Oxyura* spp.) LIKELY TO  
BE SEEN IN EUROPE  
(Drawn by Peter Scott)

Note the heavier head and swollen bill of the White-headed Duck, which is native to southern Europe, compared with the smaller but otherwise very similar North American Ruddy Duck, of which escaped individuals are at large in the British Isles.

Ruddy has a black cap and nape, white sides to the lower half of the head, and a brown body that becomes rich chestnut in the breeding-season; the drake White-headed has the whole head white except for a narrow black strip along the crown, its neck is black and its body greyish-brown; the Ruddy usually has a larger area of purer white beneath the tail (but see below) and in the breeding-season both have bright blue bills. In addition, the White-headed is a bigger, stockier bird that gives the impression of having a disproportionately large head. This heavier build is a feature of the females and young birds also, but, until one is familiar with both species, size and build can be misleading and the only really reliable character left is the swollen base to the upper mandible of the White-headed Duck, well illustrated in Mr. Scott's sketch. Both females are brown birds with a dark cap and a dark line splitting into two the otherwise pale cheeks. A somewhat uncertain secondary point of distinction is the presence or absence of white under the tail: the Ruddy Duck usually has the base of the tail constantly white in all plumages; the White-headed is normally not pure white there, but sometimes whitish and in females and young males occasionally as white as in the Ruddy (though even

then the area of white is usually more restricted). We are grateful to Mr. R. Wagstaffe of the Liverpool Museum for checking this last feature for us.

Ruddy Ducks are highly successful breeders at Slimbridge, and Mr. S. T. Johnstone, Curator of the Wildfowl Trust collection, tells us that, as a result of the difficulty in capturing and pinioning the young birds, at least twenty flew away from there in 1957; it is quite likely that the same thing will happen this year. At the moment the White-headed Duck is not kept in captivity at all.

I. J. FERGUSON-LEES

**Red Grouse swimming.**—A Red Grouse (*Lagopus scoticus*) which I flushed near Skeggles Waters, Westmorland, on 7th July 1957, glided low over the tarn, but apparently misjudged its height from the surface, and crashed into the water after flapping violently in an effort to regain height.

It appeared to be not unduly distressed and swam quite well to the shelving bank some 10 feet away, where it disappeared among the ling.

C. H. FRY

**Partridges apparently affected by industrial contamination.**—Through the kindness of Mr. M. C. Martyn I have been able to examine one of two Partridges (*Perdix perdix*) shot by him near Wentworth, Yorkshire, on 16th November 1957. Both these birds had badly deformed upper mandibles. The one examined had an upper mandible three or four times normal size, was considerably mis-shapen and had marked thickening of the roof of the mouth. This had the effect of permanently parting the mandibles so that the bird should have experienced difficulty in feeding adequately. In spite of this it appeared to be in good condition. The plumage was very dirty, and the bird had obviously endured a high degree of industrial contamination.

Mr. Martyn states that he has shot several birds similar to this one over a number of years, and some even more deformed, with their mandibles forced wide open and curved apart. They are always in good condition bodily, and always occur in the vicinity of collieries.

It does seem as if this condition may be due to some irritant resulting from the activity of collieries near-by, and may possibly be caused by a carcinogen. Dr. J. M. Harrison, who also examined the head, pointed out that the warty excrescences in the left loreal region, more or less like verruca, suggest a condition near the margin of chronic irritation and malignant transformation. He has kindly loaned me, from his collection, an adult male House Sparrow (*Passer domesticus*), which he thinks may be of the same etiology. This bird was found dying of starvation on 18th December 1925, at Gravesend, Kent, and also has a gross deformity of the upper mandible. In this case it is considerably

thickened, and projects and decurves for about  $\frac{3}{4}$ -inch beyond the lower mandible. Its plumage also showed marked industrial contamination.

It will be interesting to know whether this sort of thing has occurred in other species, and to learn more about the causal mechanism.

J. S. ASH

**Exceptional passage of Black Terns through Somerset in September 1957.**—Between 21st and 25th September 1957, remarkable numbers of Black Terns (*Chlidonias niger*) appeared in Somerset. The most striking concentration was at Chew Valley Reservoir, where at least 480 Black Terns were seen feeding on the 21st. It seems that only one larger concentration of Black Terns has ever been recorded in the British Isles and that was at Studland Bay, Dorset, on 18th August 1952 when "well over 500, and probably *c.* 1,000 or more" were seen (*Proc. Dorset Nat. Hist. & Arch. Soc.*, vol. 74, p. 141). In the passage through Somerset in September 1957, however, large parties were also noted at other inland localities and on the coast, so that the total number of birds involved was probably not less than in Dorset in 1952. The following is a summary of the records and I am grateful to the observers concerned:—

*21st September:* counts of at least 300 and possibly 450 (S. G. Madge) and at least 480 (M.W.P.) at Chew Valley Reservoir; counts of none (J. Reynolds) and 18 (S.G.M.) at Durleigh Reservoir; 87 on River Parrett at Combwich, and 192 in Bridgwater Bay (J.R.).

*22nd September:* counts of at least 90 (M.W.P.) and 180-200 (P. J. Chadwick, H. H. Davis, M. A. Wright) at Chew Valley Reservoir; 62 at Blagdon, 18 at Cheddar and 12 at Barrow Gurney Reservoirs (P.J.C., H.H.D., M.A.W.); counts of none (J.R.), 33 (T. B. Silcocks), 39 (Miss E. M. Palmer) and 49 (Bernard King) at Durleigh Reservoir; at least 70 in Bridgwater Bay (J.R.); 16 at Steart Point (B.K.).

*23rd September:* no records received.

*24th September:* 4 at Sand Bay, Weston-super-Mare (T.B.S.); none at Durleigh Reservoir (J.R.).

*25th September:* 26 in estuary of River Parrett (T.B.S.); at least 50 in Bridgwater Bay (J.R.); 97, in two parties, at Steart Point (E.M.P.).

It will be seen that the majority of the records were, as one might expect, for the week-end dates of 21st and 22nd September. However, although more records are available for the 22nd (the Sunday) than for the 21st, the total number of birds seen was considerably less, which suggests that the 21st was the genuine peak day.

While fluctuations in the numbers at the reservoirs on the 21st and 22nd are apparent, little information is available on directions of flight. The 18 birds at Durleigh on 21st September, however, circled round the reservoir and then flew off in a south-westerly direction. At Chew, no birds were seen to arrive or depart, although observations were continued from mid-morning to dusk on both the 21st and 22nd. The first indication of their presence on the 21st was of a party of 100 birds resting on a grassy spit at 11.00 hours. These birds soon rose, a few at a time, and drifted



leisurely to another section to begin feeding. They may well have just arrived, as only odd birds were seen resting after that.

Call-notes were reported from the large parties at Chew, the "kik-kik" notes being heard fairly frequently on the 21st and occasionally on the 22nd.

M. W. PICKERING

[Quite large numbers (parties of up to 50) of Black Terns were also reported at this time from other counties in the west and it is clear that the movement affected an area from Devon to Cheshire, though Somerset seems certainly to have had the greatest concentrations. In view of the analysis of "The passage of Black Terns through Britain in autumn 1954" that was made by Alec Butterfield and Kenneth Williamson (*antea*, vol. xlviii, pp. 304-307), we asked the latter if he would comment on the origin of these birds in September 1957. He writes:

"I would interpret this as a movement across the Biscay-Finistère sea-areas, originating in France and forced north-eastwards ahead of the active occluded front of an Atlantic low which advanced towards N.W. France and S.W. Britain on 20th September. This front reached both areas about midnight and then passed on across the Midlands.

"Visibility ahead of this front was bad: fog is recorded in S.E. Ireland and at Penzance, so presumably affected St. George's Channel, and similar conditions existed along the French coast from Finistère to Dieppe at midnight on the 20th/21st. Drizzle set in as the front crossed the country, and fog is indicated in seaward areas behind the front at midday. A cold front passed quickly across the same regions in the early hours of the 22nd, clearing the fog and drizzle, and during the day conditions greatly improved to moderate S.W. winds, permitting the terns to disperse.

"At the outset the weather over France was anticyclonic and generally clear with light, mostly S.E., wind. There was a distinct fall in temperature in the west Channel and Biscay regions as the occluded front passed by, the fall continuing on the Sunday.

"The same arguments apply in the present case, as did in our discussion of the effects of frontal weather on the migratory movements of Black Terns in the autumn of 1954".—EDS.]

**Lanceolated Warbler at Fair Isle.**—A remarkable "rush" of Continental birds affected Fair Isle between 16th and 22nd September 1957, and three species from central and southern areas of the U.S.S.R. appeared in the last two of these days. These were a Lanceolated Warbler (*Locustellalanceolata*) and a Richard's Pipit (*Anthus richardi*) on the 21st, and two very grey Short-toed Larks (*Calandrella cinerea*) on the 22nd. These last were considered to be of the Eastern race, *longipennis*, of which several previous individuals have been identified on Fair Isle in recent years (e.g. *antea*, vol. xlvi, p. 210; vol. xlviii, pp. 457-458).

The Lanceolated Warbler was found when Peter Hope Jones, Geoffrey Trimmingham and I examined an overgrown ditch on the croft of S. Leogh late in the afternoon. It was obvious that we were dealing with a locustelline, for in shape and skulking behaviour the bird was a miniature Grasshopper Warbler (*L. naevia*). It soon left the ditch and dived into a stook of oat-sheaves near-by, then emerged to creep through the bare stubble and the longer grasses at the verge of the field, looking more like a small mammal than a bird. It was quite indifferent to our presence, often coming within a yard of our feet, so that binoculars were superfluous.

Apart from the smaller size, the most obvious points of difference from *L. naevia* in the field were the well-defined gorget of close, parallel, vertical striations on the breast, the whitish chin and throat, an indistinct buff-white stripe through the eye, and broad dark striations on the mantle. The tail, of the same drab brown colour as the rest of the upper-parts, was very faintly barred with darker brown. The whitish belly had very few striations, but the flanks were washed darker and well streaked. The bill had a dark brown upper mandible and a pale flesh lower one; the legs were pink.

The warbler was easily caught with the aid of a piece of string netting and a portable "Craw" aluminium catching-box, and was taken to the laboratory for ringing and examination. The measurements were: wing (straight) 61 mm., (chord) 59 mm., tail 42 mm., bill 11 mm., tarsus 18 mm. Wing-formula: 1st primary 1 mm. longer than primary-coverts, 3rd longest, 2nd and 4th shorter by 2 mm., 5th by 4 mm., 6th by 5.5 mm., 7th by 6.5 mm., 8th by 7 mm.; 3rd emarginate. The weight was 7.6 gm. at 17.15 hours G.M.T. The rectrices were rather abraded, the remiges less so, and the rest of the plumage appeared new.

This is apparently the eighth British record of the species, and the sixth from Fair Isle. PETER DAVIS

## REVIEWS

AUDUBON BIRD GUIDE (Small land birds of eastern and central North America from southern Texas to central Greenland). By RICHARD H. POUGH. Illustrated by DON ECKELBERRY. (*Double-day & Co.*, New York, 1949—first edition 1946—sponsored by the National Audubon Society). \$3.95.

AUDUBON WATER BIRD GUIDE (Water, game and large land birds of eastern and central North America from southern Texas to central Greenland). By RICHARD H. POUGH. Illustrated by DON ECKELBERRY and EARL L. POOLE. (Published as above, 1951). \$3.95.

AUDUBON WESTERN BIRD GUIDE (Land, water and game birds of western North America, including Alaska, from Mexico to

Bering Strait and the Arctic Ocean). By RICHARD H. POUGH. Illustrated by DON ECKELBERRY and TERRY M. SHORTT. (Published as above, 1957). \$4.95.

THE BIRD-WATCHING VISITOR to the United States or Canada is now as well-served with field-books as any visitor to any continent, as a consequence of the planning wisdom of the designers of the Pough series, reviewed here, and the equally famous Peterson series, published by Houghton Mifflin of Boston. If he can afford the dollar outlay he should buy both series. If his visit keeps him east of the 100° meridian he will be adequately served by Peterson's *Field Guide to the Birds* and by the first two books reviewed here. West of 100° he will need the Peterson *Field Guide to Western Birds* and all three Pough books. Neither Peterson book covers Alaska and the Canadian North-West; used together, the three Pough books do. The third and most recent Pough Guide, published last year, is a "mop-up" manual, dealing *in extenso* only with those western species not covered by its two predecessors: this has its disadvantages, as the user has to thumb his way through at least two Guides before he can find his bird. But he can get there soon enough, aided by beautifully printed and well laid-out text and pictures, and guided by a skilful and up-to-date account and description of the birds, and by the excellent Eckelberry plates which maintain a fine standard of accuracy throughout.

Pough's text, in all his Guides (part of it, particularly in the Western Guide, is contributed by H. C. Cogswell, J. T. Marshall and other experts), is more extensive than that in the handier Peterson Guides, which confine themselves largely to the essentials of recognition and do not deal widely, as Pough does, with habits. Further comparisons between the two series are almost unnecessary, so complementary are they; but it would have been better had the Eckelberry colour plates been distributed through the Pough Guides in the Peterson style, rather than lumped together, so that many birds are figured far away from their text.

In every way the Pough Guides show a fine judgment of relevant fact. The text flows well, yet remains concise and valuably informative. Vernacular names have been brought in line with the most recent American trend, which is much closer to that of Europe than the fancy was formerly and which concentrates upon species rather than races. Indeed, Pough has included notes on races only when they are of value to the field-man; he confines his remarks on subspecies to the few which are well-marked enough to be reliably recognizable in the field.

From end-paper to end-paper (which carry most useful maps) the Audubon Bird Guides of Pough reflect credit on him, his talented artists, and the National Audubon Society that has sponsored them. So well-arranged and valuable is the information in them that no European ornithologist who follows American

work can afford to be without them—even if he cannot manage a trip to America. Those of us who read *The Auk*, *The Condor*, *The Wilson Bulletin*, *Bird-Banding*, or any other fine American ornithological journal often wonder what the birds are like: a coloured picture and a summary of distribution and habits form no part of a normal scientific paper. These Guides give, in truly portable form, the most complete description of the bird fauna of North America, north of the Mexican border, that can be obtained. They have had a well-deserved success throughout their continent, and deserve to be widely read and enjoyed in others. JAMES FISHER

## LETTER

### SOCIAL FLYING OF RAVENS

SIRS,—Under the above title (*antea*, vol. L, pp. 432-434), R. Hewson has usefully drawn attention to the aerobatics—familiar in individuals—that are sometimes performed by flocks of Ravens (*Corvus corax*) and has discussed questions suggested by this form of behaviour. His citations of literature, however, go no further back than 1948, and I should think it a pity if the record of the subject in your pages did not also include the following much older reference; as the source is not a very accessible one, I may be permitted to quote the most relevant passages.

J. C. Adam (1909), under the title "The Raven Wyses" (*Trans. Edinburgh Naturalists' and Microscopical Soc.*, vol. 6, pp. 152-163), described an incident observed by himself and his brother somewhere in Scotland late in the afternoon of 11th March 1906. Upwards of a dozen birds "were disporting themselves just as we had seen odd pairs doing before and long after the nesting-season. They were even carrying the play further: we could see, in spite of the distance and the poor light, birds bearing sticks or heather-bents in their bills; we could see a bird drop one and then dive after it, make a movement as if it had caught it in the air, and then swing upwards pursued by two or three of its fellows who a moment before had made wild dashes to intercept it. There was also a great deal of other circling and tumbling and sudden dives, for which we could not perceive the reason—the birds probably played with smaller articles than sticks, which were invisible at our distance. The whole business left the impression of birds gathered for play and for nothing else".

He goes on to tell how two ornithological friends had a similar experience twenty miles from the same spot a fortnight later, on 23rd March, under more favourable conditions; and, after watching the performance for an hour, had the good fortune to witness the dispersal. "And this is the interesting point: they had dispersed in twos—first one pair left the convivial crowd, and then at a short interval a second, and then a third, each heading away in a different direction, until the last farewell had been croaked across the hills". Adam concluded that this must be a

gathering of resident birds (mentioning that on the second date most Ravens would be incubating—but it has since been pointed out that non-breeding birds may be paired), and that the assembly was not attributable to any food attraction.

The article is in the main a somewhat whimsical account of personal experience; but J. C. Adam was a fine observer—one of the many ornithologists of my own generation who did not survive the first world war. The brother who was with him is R. M. Adam, well-known as a photographer of Scottish scenery. One of the second pair of witnesses was evidently another member of the group—we called ourselves the Macgillivray Society—as I have still in my possession a typescript account of the incident by William Binnie, with sketches made in the field. Binnie also lost his life in the war, but from his record one learns that the locality was in Perthshire, the time again late in the day, and the number of birds nine. Further, he describes and depicts the birds as playing in the air not only with pieces of stick but also with small white stones. Moreover, the four sketches show a piece of stick being carried in both feet, and either dropped from or caught by them; and, for another bird, a small stone being carried in and about to be caught with the bill.

The following further observation perhaps bears on the pair composition of performing flocks. D. A. Bannerman (*Birds of the British Isles*, Vol. 1, 1953) quotes a description by B. H. Ryves of two pairs of Ravens on the Cornish coast performing aerial dances simultaneously a hundred yards apart. The account continues:—"Soon the two pairs converged rapidly inwards until they met. Then followed precisely the same aerobatics as before, only by four birds instead of two, lasting about a minute, after which, as if by some subtle prearrangement, the pairs separated to continue their dance in distinct couples".

It may be remarked that William Macgillivray himself (*History of British Birds*, Vol. 1, 1837), who knew the species intimately in the Hebrides, described both large assemblages and individual acrobatic flight but had apparently never witnessed social flying of the kind with which we are here concerned.

A. LANDBOROUGH THOMSON

## RECENT REPORTS AND NEWS

By I. J. FERGUSON-LEES and KENNETH WILLIAMSON

**The items here are largely unchecked reports, and must not be regarded as authenticated records. They are selected, on the present writers' judgment alone, from sources generally found to be reliable. Observers' names are usually omitted for reasons of space and in case a report is subsequently rejected, and none of the items will be mentioned in our annual Index. Readers are asked to submit anything of interest as quickly as possible.**

This summary deals with the second phase of the spring passage, the period 1st-20th May. At the beginning of the month an anti-

cyclone covered much of Europe and Britain, and, at the centre of this high, fog developed in the early morning of the 1st all along the Dutch coast: this and easterly winds in the North Sea were probably the causes of the large but brief and fairly local invasion of Black Terns (*Chlidonias niger*) during 1st-3rd May (*antea*, p. 206). Apart from the six flocks of 100-400 detailed last month, there were several parties of 40-90 birds, but these concentrations were only in the area bounded by Norfolk and Northamptonshire in the north (peak on the 1st) and Essex and Hertfordshire in the south (peak on the 2nd). Numbers elsewhere were small, with parties of 23 (Lincolnshire and Hampshire) the largest reported, though Black Terns were scattered over most of England from Yorkshire to Lancashire and Kent to Dorset.

The centre of the high contracted to southern England and the Channel region between the 2nd and the 5th, and in this period a big eastwards movement of sea-terns (*Sterna* spp.) was observed at various places along the Channel coast from Dorset to Kent. These were mainly Sandwich (*S. sandvicensis*) and Common/Arctic Terns (*S. hirundo/macrura*), with fewer Little (*S. albifrons*); at the same time there were some Arctic Skuas (*Stercorarius parasiticus*), as well as one or two Pomarines (*S. pomarinus*) of which 6 adults (4 pale and 2 dark) were seen at Dungeness on the 2nd and single birds at Dungeness and Portland on the 4th. Common Scoters (*Melanitta nigra*) were also reported as part of this movement and several Black-throated Divers (*Gavia arctica*) in summer plumage were noted at Portland.

At this time south European birds were coming to the east and south coasts, as far west as the southern Irish Sea, in the light easterly airflow over France and the Biscay-Finistère approaches (Fig. 1). A Tawny Pipit (*Anthus campestris*) appeared at Dungeness on the 2nd, and another was seen in Cheshire, on the Dee marshes near the Flintshire border, on the 4th. Also at Dungeness on the 2nd there was a Gull-billed Tern (*Gelochelidon nilotica*), and that same day a Hoopoe (*Upupa epops*) circled over Monks' House, Northumberland, just as the week's guests were leaving! Apart from this rather northerly bird and one at Bardsey, Caernarvonshire, on the 4th, there were a number of reports of Hoopoes in southern counties (Essex, Kent, Sussex, Hampshire, Devon), during the first eleven days of the month. A Woodchat Shrike (*Lanius senator*) arrived at Great Saltee, Co. Wexford, on the 3rd, and there was another at Salthouse, Norfolk, on the 4th (and also one at Hilbre, Cheshire, on the 10th). The Salthouse Woodchat, a male, could be watched at the same time as a Great Grey Shrike (*L. excubitor*); both remained several days, the Woodchat to the 9th, the Great Grey to the 8th. Another latish Great Grey Shrike was seen at Hecklingham, Norfolk, on 14th May.

The movement which brought the Woodchat to Saltee resulted in a male Subalpine Warbler (*Sylvia cantillans*) visiting St. Agnes

in the Scilly Isles on the 3rd (it stayed until the 7th), and on the next day there was a female Bluethroat (*Cyanosylvia svecica*) there, as well as an Ortolan Bunting (*Emberiza hortulana*) which remained until the 6th. A female Ortolan was also reported from Epsom, Surrey, on the 3rd, while on the 7th and 8th a male in song was found at the same place. On 4th May there was a female Grey-headed Wagtail (*Motacilla flava thunbergi*) at Fair Isle, while at Gibraltar Point, Lincolnshire, a male Golden Oriole (*Oriolus oriolus*) and a Long-eared Owl (*Asio otus*) (rare on the east coast in spring) were noted. On the south coast during 3rd-4th May there was a fall of Whitethroats (*Sylvia communis*) and Willow Warblers (*Phylloscopus trochilus*), with a sprinkling of such birds as Whinchats (*Saxicola rubetra*), Redstarts (*Phoenicurus phoenicurus*) and Turtle Doves (*Streptopelia turtur*). On the 5th there was a movement of Sedge Warblers (*Acrocephalus schoenobaeris*) to Bardsey. Sedge Warblers had also been common on passage at Mönks' House at the beginning of the month, together with Willow Warblers (including several *acredula*), chats and Goldcrests (*Regulus regulus*).

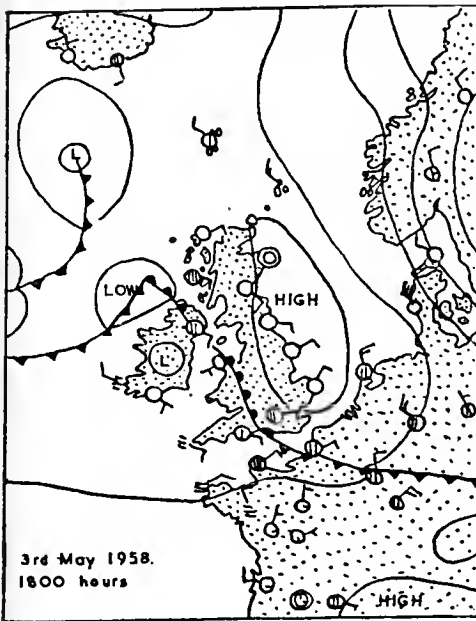

Fig. 1



Fig. 2

Fig. 1 shows the situation of the early May anticyclone at 18.00 hours on the 3rd: S. European rarities arrived on the east and south coasts, round to the Scilly Isles and Great Saltee, from the 2nd to the 4th, and Greenland Wheatear passage was very heavy at St. Kilda on the 3rd (see text). Fig. 2 illustrates the cyclonic drift of eastern rarities to Fair Isle overnight on 14th/15th May from the southern Baltic Sea and Skagerrak in pre-frontal easterly winds (see text).

The centre of the anticyclone had moved briefly to the Hebrides and northern Scotland late on the 2nd, before returning to the south-east, and a great rush of Greenland Wheatears (*Oenanthe oe. leucorrhoea*) developed at St. Kilda on the 3rd, the

birds continuing abundant until the 6th. A flock of Barnacle Geese (*Branta leucopsis*) had passed on the 2nd, and a second Iceland Gull (*Larus glaucoides*) joined the one mentioned last month (*antea*, p. 207). A good Greenland Wheatear passage was also reported from Monk's House, and from Fair Isle where the peak day was the 6th.

The anticyclone moved away to southern Europe, and Britain was troubled by low pressure disturbances, though col and ridge conditions gave a brief respite in the south on the 6th and 7th before more depressions, with active fronts and strong westerly winds, came in from the Atlantic. A gale on the night of the 8th/9th, with pre-frontal east wind, brought a second wave of Wheatear and Barnacle Goose passage to St. Kilda. A possible Nightingale (*Luscinia megarhynchos*) was seen at Fair Isle on the 7th and 8th (there is only one record for the island, but see below), with an Ortolan on the latter date. At the other end of Britain on the 7th there was a male Little Bittern (*Ixobrychus minutus*) in the Yare Valley, Norfolk, and we have received preliminary and incomplete details of a Lesser Grey Shrike (*L. minor*) at Dartford, Kent. A Sparrowhawk (*Accipiter nisus*) trapped at Fair Isle on 7th May had been ringed as a migrant at the Isle of May, in the Forth, on 23rd September 1957.

At Bradwell, Essex, the largest movement of the spring took place on about 8th May: chiefly Whitethroats and Willow Warblers (including some *acredula*), but including a few Spotted Flycatchers (*Muscicapa striata*). A heavy passage of Spotted Flycatchers occurred at Monk's House from the 6th to the 8th, and on the 9th a Spotted Crake (*Porzana porzana*) was found dead at Holy Island, Northumberland. Between that date and the 11th there was more strong passage in Durham and Northumberland, this time of northern Wheatears, Willow Warblers (again with *acredula*) and unusual numbers of Common Sandpipers (*Tringa hypoleucos*). In the second week of May, too, there was a small movement of summer migrants at Fair Isle, mainly Pied Flycatchers (*Muscicapa hypoleuca*), Redstarts and Willow Warblers.

About this time there was an influx of Spoonbills (*Platalea leucorodia*) to Norfolk, 1 being seen at Breydon on the 10th, 2 at Hickling Broad during the 10th-17th (and then 2 at Breydon from the 18th) and 2 at Cley from the 13th onwards. The Spoonbill at Hanningfield, Essex (*antea*, p. 207), incidentally, was still present there on 18th May. A Little Egret (*Egretta garzetta*) stayed on the Hayle estuary, Cornwall, from 8th to 10th May; then 1 was found near Rye, Sussex, on the 16th and on several days subsequently. A female Red-footed Falcon (*Falco tinnunculus*) remained at Southwold, Suffolk, from the 9th to the 14th. Two Short-toed Larks (*Calandrella cinerea*) were watched at St. Agnes on the 10th, and from Gwithian in Cornwall came a report of a Golden Oriole on that day. In view of the generally westerly



weather then, it is possible that some of these were "left over" from the earlier anticyclonic influx of south European birds. To date, only two other Golden Orioles have been reported, apart from the ones at Gwithian and Gibraltar Point, and these were single birds at Beckley on 30th April and in the Epping Forest, Essex, on 18th May—but there have probably been others.

A Madeiran Little Shearwater (*Procellaria caroli caroli*) was picked up moribund at Stockport, Cheshire, on the 10th and is now in the Bolton Museum. Also on 10th May a near-adult Sabine's Gull (*Xema sabini*) was seen at Portland.

The most surprising bird of the month was a female Wilson's Phalarope (*Phalaropus tricolor*) in summer plumage near Shefford, Bedfordshire, from the 10th to the 13th; there is only one previous authenticated record of this species in Europe (*antea*, vol. xlviii, pp. 15-17). It may well, however, have been newly-arrived when discovered, for during the 8th and 9th winds were westerly across the Atlantic with low pressure near both coasts and an anticyclone to the south between.

From the 11th to the 13th, with the low pressure centres filling to the west and northern Scotland enjoying calms or light easterly airs, four new species were added to the St. Kilda list: a drake Tufted Duck (*Aythya fuligula*), a Dunnock (*Prunella modularis*), a House Sparrow (*Passer domesticus*) and a Nightingale! Willow Warbler, Chiffchaff, Sedge Warbler, Whinchat and Chaffinch (*Fringilla coelebs*) were other species seen. Some ringed Turnstones (*Arenaria interpres*) feeding on the shore of Village Bay were doubtless a few of those caught there in September 1957. Incidentally, it now seems clear that Dunnocks were quite a significant, if overlooked, bird in the March and April movements discussed last month (*antea*, pp. 203-206) and their presence has been commented on from Havergate, Suffolk, to Fair Isle: at the latter place nearly 40 Continental Dunnocks (*P. m. modularis*) were trapped in the six weeks following 30th March, twice as many as in any previous entire year.

The Iceland Gull at Shoreham, Sussex, was still present on 16th May (see *antea*, p. 207) and another southerly individual was located at St. Ives Bay, Cornwall, on the 13th. Waders were prominent on the Durham and Northumberland coasts from the 11th and 12th: up to 1,000 black-bellied Dunlins (*Calidris alpina*) were reported at Teesmouth and Fenham Flats on these dates respectively, and there was a party of Reeves (*Philomachus pugnax*) at the latter locality. Ruffs and Reeves, incidentally, had been numerous at Cley, Norfolk, at the beginning of the month when a total of 40-50 were seen on the marsh there. During the mid-May period Turnstones and Purple Sandpipers (*Calidris maritima*) were continually passing at Monks' House (and a late Black Redstart (*Phoenicurus ochruros*) appeared there on the 13th). The middle of the month also saw a trickle of Turnstones and Sanderlings (*Crocethia alba*) inland where neither of these

species is at all commonly recorded: for the first and third days of its stay (10th and 12th May) the Wilson's Phalarope in Bedfordshire was accompanied by a Sanderling, and others of this species were reported from Cannock reservoir, Staffordshire, on the 11th and Little Paxton, Huntingdonshire, on the 12th. Turnstones also appeared at these two localities: 3 at Cannock on the 11th and 2 on the 12th, and 1 at Little Paxton on the 16th.

At this period there was high pressure over Scandinavia and eastern Europe, but rain developed in the Skagerrak and southern Baltic Sea in the warm front of a low which pressed north-eastwards across the British Isles (Fig. 2). Passage of the normal summer-visitors was renewed at Fair Isle on the 14th and 15th, with more Ortolan Buntings, a male Yellow Wagtail (*M. f. flavissima*) and a party of 15 Tree Sparrows (*Passer montanus*) among the more unusual birds there. A Thrush Nightingale (*Luscinia luscinia*), of which there are only three previous British records, was trapped and another "probable" seen; this is the second year in succession that a Thrush Nightingale has been caught at Fair Isle (see *antea*, p. 198) and this time the date was 15th May, the 47th anniversary of the first British record, secured at Fair Isle by Dr. Eagle Clarke! On this same day there were 2 Little Buntings (*Emberiza pusilla*) (*cf. antea*, p. 205); and a Red-throated Pipit (*Anthus cervinus*) from the 18th to the 20th completed this galaxy of eastern rarities as far as Fair Isle was concerned. But other parts of the country were also receiving Continental vagrants. A Roller (*Coracias garrulus*) on St. Mary's, Scilly Isles, in the middle of the month was subsequently found dead. A Purple Heron (*Ardea purpurea*) was found at Chichester gravel-pits, Sussex, on the 18th, and that same day what was considered to be a Purple Heron was seen in flight at Dunstable, Bedfordshire. Also on the 18th a Gull-billed Tern appeared at Hayling Island, Hampshire. And another female Red-footed Falcon was located on 21st May, this time at Wareham, Dorset; it was still present to at least the 24th.

Finally, a word about Jays (*Garrulus glandarius*). Several reports have come from Sussex, Hampshire and Dorset, which suggest a movement of these birds. Most observations, chiefly in the last ten days of April and the first half of May, concern ones and twos in coastal places where there are normally no Jays, but there is also a report of more significant numbers from the Durlston Head area in Dorset, on 10th, 12th and 15th May. On each of these days a group of about 20 (once 23) was seen in the early morning, twice flying S.S.E. and once west; possibly the same birds were involved, but the actual observations suggested otherwise and, in addition, 7 on the headland in mid-morning on the 10th were not to be found that afternoon. It should be remembered that the Jay was one of the "associated species" connected with the big movements of tits (*Parus spp.*) and other birds in the autumn of 1957 (*cf. antea*, p. 208), and further information of this kind would be useful.

## NOTICE TO CONTRIBUTORS

*British Birds* publishes material dealing with original observations on the birds of Britain and western Europe, or, where appropriate, on birds of this area as observed in other parts of their range. Except for records of rarities, papers and notes are normally accepted only on condition that the material is not being offered to any other journal. Photographs (glossy prints showing good contrast) and sketches are welcomed. Proofs of all contributions accepted are sent to authors before publication. After publication 20 separates of papers are sent free to authors; additional copies, for which a charge is made, can be provided if ordered when the proofs are returned.

Contributors are asked to observe the following points, attention to which saves the waste of much editorial time on trivial alterations:

1. Papers should be typewritten with double spacing, and on one side of the sheet only. Shorter contributions, if not typed, must be clearly written and with similar spacing. Failure to help in this way may result in delays to publication.

2. Notes should be worded as concisely as possible, and drawn up in the form in which they will be printed, with signature in block capitals and the writer's address clearly written on the same sheet. If more than one note is submitted, each should be on a separate sheet, with signature and address repeated. In the case of rarity records, any supporting description which is too detailed for publication should be attached separately.

3. Certain conventions of style and lay-out are essential to preserve the uniformity of any publication. Authors of papers in particular, especially of those containing Systematic Lists, Reference Lists, Tables, etc., should consult the ones in this issue as a guide to general presentation. English names of species should have capital initials for each word, except after a hyphen (e.g. Siberian Thrush, Yellow-headed Wagtail), but group terms should not (e.g. thrushes, wagtails). English names are those used in *The Handbook of British Birds*, with the exception of the changes listed in *British Birds* in 1953 (vol. xlvii, pp. 2-3). The scientific name of each species should be given (in brackets and underlined) immediately after the first mention of the English name. Sub-specific names should not be used except where they are relevant to the discussion. It is sometimes more convenient to list scientific names in an appendix. Dates should take the form "1st January 1955" and no other, except in Tables where they may be abbreviated to "1st Jan.", "Jan. 1st", or even "Jan. 1", whichever most suits the lay-out of the Table concerned. It is particularly requested that authors should pay attention to Reference Lists, which otherwise cause much unnecessary work. These should take the following form:

TUCKER, B. W. (1949): "Species and subspecies: a review for general ornithologists". *Brit. Birds*, xlii: 129-134.

WITHERBY, H. F. (1894): *Forest Birds: Their Haunts and Habits*. London. p. 34.

Various other conventions concerning references, including their use in the text, should be noted by consulting previous examples.

4. Tables should be numbered with Roman numerals, and the title typed above in the style used in this issue. The title and any headings within the Table should not be underlined, because this sometimes makes it difficult for the Editor to indicate the type to be used. It is most important that the lay-out of each Table should be carefully planned with an eye to its final appearance; above all, it should be borne in mind that Tables must either fit into the width of a page, or be designed to fit a whole page lengthways. All Tables should be self-explanatory.

5. Figures should be numbered with Arabic numerals, and the captions typed on a separate sheet. All line-drawings should be in Indian ink on good quality drawing paper (not of an absorbent nature) or, where necessary, on graph paper, but this must be light blue or very pale grey. It is best if maps, graphs, etc., are drawn twice the size of the final reproduction (ideally, therefore, for the normal 4" width the original should be 8" wide); sketches of birds, however, should be only slightly larger than the size at which it is intended they should appear. It is always most important to consider how each drawing will fit into the page. The neat insertion of lettering, numbers, arrows, etc., is perhaps the most difficult part of Indian ink drawing and, unless he has had considerable experience of this kind of work, an author should seek the aid of a skilled draughtsman. The publishers regret that, owing to rising costs, it will in future be only in exceptional cases that they can undertake to have lettering inserted.

**Captured German Stores**

**LEITZ**

(of Leica fame)

**10 X 50 Eyepiece Focusing**

**BINOCULARS**

**The ideal glass for the**

**BIRDWATCHER**



An extremely well made instrument combining high magnification with good light transmission.

Weight 2 lbs. Current cost approx. £60. Excellent condition, with leather case

**£26**

*We have specialised in fine quality binoculars and optical equipment for half a century and carry Europe's greatest stocks of ex-Govt. binoculars. Every purchase is covered by our money-back guarantee and, if requested, will be sent on 7 days' free approval, Credit terms available if desired.*

**GERMAN ARMY  
BINOCULARS**

**6 X 30**

Best makes. Eyepiece focusing. Weight only 14 ozs. Shock- and water-proofed. With all-weather case. Fraction of cost

**£7 15s. 0d. to £10 15s. 0d.**

**EX-ADMIRALTY ROSS 16 X 40**

**SINGLE DRAW TELESCOPE (Micrometer Focusing)**

The Ross telescope is famous throughout the world and this model, produced to exacting Admiralty standards, combines an extremely high light transmission with a wide field of view. Length closed 11", fully extended 17½". Focusing is achieved by specially quick micrometer system. Of all the Admiralty scopes this is the lightest, being only 28 ozs. in weight. These telescopes are offered at well under half cost price. Almost mint condition.

**£5 . 18 . 6**

**POSTAGE 2/6**

**CHARLES FRANK**

**67-75 SALTMARKET, GLASGOW, C.I.**

Telephone : BELL 2106-7

Established 1907

# BRITISH BIRDS



JULY 1958

THREE SHILLINGS

# BRITISH BIRDS

AN ILLUSTRATED MONTHLY MAGAZINE

Edited by

E. M. NICHOLSON

W. B. ALEXANDER                      A. W. BOYD

I. J. FERGUSON-LEES

P. A. D. HOLLOM                      N. F. TICEHURST

*Editorial Address* : 30, St. Leonard's Avenue, Bedford.

*Photographic Editor*: G. K. YEATES

Annual Subscription £2 (including postage and despatch)  
payable to H. F. & G. Witherby Ltd., 5, Warwick Court, London, W.C.1

---

---

## CONTENTS OF VOLUME LI, NUMBER 7, JULY 1958

---

	PAGE
The wreck of Kittiwakes in early 1957. By Miss Leontia McCartan	253
Mortality of Kittiwakes during the breeding season. By Miss Leontia McCartan ... ..	267
Photographic studies of some less familiar birds. XC—Frigate Petrel. Photographs and text by John Warham (plates 41-44) ... ..	269
The moult migration of the Shelduck from Cheshire in 1957. By R. H. Allen and G. Rutter ... ..	272
Notes:—	
Magpie burying and recovering food (R. W. Hayman) ... ..	275
Unusual nest of Song Thrush (E. L. Roberts) ... ..	275
Desert Wheatear in Essex (B. A. B. Barton) ... ..	275
Goldercrest caught on hooks of burdock (Miss W. U. Flower) ... ..	276
Corn Buntings roosting in reeds (K. G. Spencer) ... ..	276
Review:—	
<i>Bird Study in a Garden</i> . By E. A. R. Ennion ... ..	276
Recent reports and news. By Kenneth Williamson and I. J. Ferguson-Lees ... ..	277

---

Cover photograph by C. Pearson Douglas: Buzzard (*Buteo buteo*) in flight

CHASED

1 AUG 1958

VOL. LI

No. 7

JULY

1958



## BRITISH BIRDS

---

---

### THE WRECK OF KITTIWAKES IN EARLY 1957

By LEONTIA McCARTAN

(Department of Zoology, University College of Wales,  
Aberystwyth)

THE KITTIWAKE (*Rissa tridactyla*) is an oceanic bird which breeds along the North Atlantic shores, down to about  $40^{\circ}\text{N}$ . At the end of the breeding season the birds move out to the open Atlantic and during the winter months they are found chiefly between  $40^{\circ}\text{N}$ . and  $55^{\circ}\text{N}$ . (Wynne-Edwards, 1935). Rankin and Duffey (1948) have shown that in January and February the main concentration of wintering birds occurs between  $20^{\circ}\text{W}$ . and  $40^{\circ}\text{W}$ .

Many Kittiwakes also winter in British waters, though they do not normally occur close inshore at that time of the year and they are then rarely seen either on the coasts or inland. During the early months of 1957, however, Kittiwakes were reported from various parts of the British Isles and it became apparent that some abnormal movement of the birds was in progress.

This present survey of the extent of the irruption was made possible by the co-operation of all those who sent in reports and observations in response to the notices in various journals. The names of all contributors are listed at the end of the paper; I should like to thank them for their assistance and to apologise for any inadvertent omissions.

The wreck of Kittiwakes was confined mainly to the south and west. Flocks of varying size were stranded at different parts of the coast during January and February, and the distribution of these flocks is shown in Fig. 1. For convenience, all the records from Somerset have been included with the coastal flocks. Altogether over 900 birds were counted in the coastal flocks (excluding over 500 birds which were reported alive in Northern Ireland in December 1956).

In addition, about 90 birds were found in England and Wales,



FIG. 1—DISTRIBUTION OF COASTAL FLOCKS OF KITTIWAKES (*Rissa tridactyla*) IN THE BRITISH ISLES IN EARLY 1957

Any group of more than five birds was treated as a "flock" and the details are given in Appendix I on pages 261-263. This map illustrates the fact that the large numbers were mainly confined to the south and west. Most of the birds died.

and of these over 80% occurred south-west of a line drawn from Liverpool to London; 17 birds were found inland in Scotland and



8 in Ireland. Full details of the size and distribution of the coastal flocks and a list of the inland records are given in Appendix I.

The first reports (again excluding the December flock in Northern Ireland) were a few isolated records for January. During February there was a steady increase in the numbers of both living birds and corpses, and peak numbers were reached about 15th-20th February. After this date there was a drop in numbers, presumably due to deaths. Some Kittiwakes were still seen flying as late as March, but most of the March records were of corpses in varying stages of decay. By the middle of March all signs of the wreck had disappeared and a normal spring return to the breeding grounds followed.

Many of the birds were dead when found. A few of the living birds appeared to be healthy and in good condition, but the vast majority drew attention to themselves by their unusual tameness and disinclination to fly away when approached. At Brighton and Newhaven in Sussex and Southend-on-Sea in Essex they roosted fearlessly on the piers and on the life-boat station roof. Observers' comments on the birds included such adjectives as "tame", "tired", "lethargic", "dopey" and "unafraid". Often the weakened birds were cared for and fed for a few days, but none recovered. For the purpose of this survey there seems to be no point in separating the birds into arbitrary categories of "alive" and "dead", as the evidence strongly suggests that all the birds eventually died.

In some cases the Kittiwakes were too weak to stand and lay forwards on their breasts; others could just manage to walk slowly and stiffly, and others still (at Portaferry, Northern Ireland) flew for a short distance when disturbed by a dog, but, on alighting again, fell over sideways as though their legs were too weak to support them. One bird, in Cornwall, could not rise to its feet without levering itself up by the tip of its beak; others were found dead in this position, as though they had nose-dived into the soft soil.

Despite their weakness the birds soon located and used alternative food supplies. At Brighton and Newhaven a small flock fed regularly at a sewer outfall and took scraps from the floor of the fish market and bait dropped by anglers on the pier. At Wembury, Devon, a flock of 60-70 Kittiwakes was seen in a ploughed field, apparently feeding on earthworms. Reports from other areas also mention the birds picking at grass and wet turf; one bird was seen picking at a dead Cormorant (*Phalacrocorax carbo*) and another, opened at Aberystwyth, had pieces of silver paper and rubber bands in its stomach.

Most of the birds which were hand-fed took fish offal, pieces of herring or liver (this was the food most commonly offered to them), and at first none of them refused food; before death, however, many birds did refuse to eat and had to be fed forcibly.

As a general rule these Kittiwakes died after three or four days of hand-feeding, although in a few instances they had apparently made an initial recovery. Death seemed to follow a standard pattern: the bird became even weaker, lay forward on its breast, dipped its head, spread its wings to full span and died. The wing spreading seems to have been a general feature, and many of the reports of birds found dead show that the corpses were found with outstretched wings and "appeared to have died in that position".

With the exception of the birds on the Hampshire coast very few of the Kittiwakes were heavily oiled. A small number, less than a dozen in all, showed slight traces of oil which might have been acquired on the beaches either immediately before or just after death, but over 98% were clean birds showing no sign of oil contamination; nor was there any indication of fuel oil pneumonia in the post-mortem reports.

On the Hampshire coast, however, a considerable quantity of oil was washed ashore during the December and January gales and several species of sea birds suffered heavy oiling. In one day 19 oiled Kittiwakes were destroyed. Flocks of over 100 living Kittiwakes were reported during the wreck; most of these birds showed slight traces of oil, but the evidence suggests that they were quite clean on arrival in the vicinity and were picking up oil during their stay. One observer watched these birds hovering over patches of oily sea water, thus getting the oil on their plumage and legs.

The mortality did not appear to be confined to one age group. In Jersey, Channel Islands, there was a high proportion of first-year birds among the casualties, but this tendency was not apparent in reports from other parts of the British Isles. Only a few reports gave details of the ages of the birds involved and, of a total of 122 birds of known age, 102 were adults, but it would be unwise to attach much significance to these figures.

#### RESULTS OF POST-MORTEM EXAMINATIONS

The full significance of the wreck was not appreciated until after the main peak of mortality had passed and, as a result, very few corpses were examined critically or sent in for pathological investigation. Some of the birds were badly decayed when found and many were destroyed or buried. Many observers reported that the birds which they had handled were very thin and underweight. Two observers in Somerset, P. J. Chadwick and M. A. Wright, checked the weights of the corpses in their area and found that the maximum weight was 360.8 gm., the minimum 225.1 gm. and the mean (for 17 corpses) was 277.06 gm. Scilkopf (1955) gives 420 gm. as the mean weight of healthy birds; White (personal communication) gives 354 gm. as the mean weight of 57 adult Kittiwakes, weighed during the breeding season.

Wrecked birds from Somerset showed severe starvation, and internal examination revealed complete absence of the fat deposits

as well as atrophy of the pectoral muscles and liver. Samples of various tissues were taken from these birds and preserved and sectioned for histological examination by R. H. Poulding. 14 livers were weighed and had a weight range of 4.00 gm. to 14.18 gm., with an average weight of 7.84 gm. Histological examination of these livers revealed shrinkage of the cells and complete absence of glycogen, a food reserve of the body which is normally present in very large quantities in the liver. Fat, which does not normally occur in appreciable amounts in the liver, was present in large quantities. This accumulation of fat in the liver indicates the first stages in its breakdown, when the body is deriving energy from fat sources rather than from carbohydrate sources. The pectoral muscles also showed fatty degeneration, which again indicates a derailment of the metabolism, and the thyroid glands showed abnormal conditions which were symptomatic of the changes in the metabolism due to starvation. Details of the histological examinations are given in Appendix II.

Even without microscopic examination there was no difficulty in diagnosing that many of the birds were starving. One observer attempted to skin one of the corpses and reported as follows: "The body was terribly emaciated and the flesh had a strange mealy texture as though the muscle fibres were separating out and tending to adhere to the skin".

Six corpses were examined for parasites and pathological conditions, and the results are listed in Table I. A new species of *Coccidium* was isolated and identified from this material (Soulsby and Jennings, 1957). Unfortunately none of these birds was weighed.

TABLE I—RESULTS OF EXAMINATIONS OF DEAD KITTIWAKES (*Rissa tridactyla*)

Date	Locality	Examined by	Result of Examination
9th Feb.	Swansea (2 corpses)	Dept. of Animal Pathology, Cambridge	Acute pulmonary oedema. General venous congestion, probably due to some toxins.
17th Feb.	Yealm Estuary, Devonshire	Public Health Laboratory, Plymouth	Severe wasting of the muscles and subcutaneous tissue. Both lungs fibrotic with long-standing adhesions. Extensive <i>Aspergillosis</i> in the lungs.
20th Feb.	Aberystwyth	Cambridge	Acute coccidiosis. Infections of <i>Surattia shepleyi</i> and <i>Acanthocephala</i> spp.
21st Feb.	Aberystwyth (2 corpses)	Veterinary Investigation Office, Aberystwyth	Congestion of the lungs and liver.

#### WEATHER CONDITIONS BEFORE THE WRECK

From 4th January to 11th February a succession of depressions moved eastwards across the North Atlantic, bringing inter-

mittent gales with a strong westerly component to the whole of the North Atlantic area. In particular between 25th and 26th January strong north-westerly gales were reported to extend from Greenland, becoming south-westerly as they approached the British Isles. Simultaneously, west to south-westerly gales were reported in the western Atlantic. During this entire period, then, the whole Atlantic was swept by persistent strong gales from westerly points (see *British Daily Weather Reports* for the period).

#### THE 1957 WRECK IN OTHER EUROPEAN COUNTRIES

During the early months of 1957 unusual occurrences of Kittiwakes were reported from various countries of Western Europe. Solitary birds were seen in France, in the vicinity of Paris, between 16th and 28th February (Lévêque and Mayaud, 1957), and after these dates there were other reports. The wreck in France has been surveyed by the Société ornithologique de France (Jouanin, 1957). A bird which had been ringed in Greenland in July 1955 was found inland in Landes, France, on 12th February, and another bird, ringed in Greenland in July 1947, was found in Holland, near Scheveningen, on 28th February (*per* Dr. Finn Salomonsen).

Four Kittiwakes were found in Luxemburg on 14th and 15th February and on 15th March, one in Germany on 2nd February and small numbers in Switzerland between 17th February and 22nd February (Hulten, 1957). A slight increase in the normal number of Kittiwake corpses was reported from Norway, but no figures are available (*per* Dr. H. Holgersen).

R. Lévêque reports that, while crossing the North Sea from Harwich to the Hook of Holland on 2nd February, he saw flocks of several hundred Kittiwakes which were mostly adults.

#### PREVIOUS WRECKS IN THE BRITISH ISLES AND IN OTHER EUROPEAN COUNTRIES

Although there are no reports of large-scale wrecks in the British Isles before 1957 there are a number of records of storm-driven birds which have been picked up at various times in inland counties. The examples which follow are selected chiefly from the south and west.

On 21st November 1922 there were 3 birds at a Staffordshire reservoir (Alexander, 1923). There was 1 bird in Staffordshire on 29th March 1930 and single birds in Cheshire on 18th March 1926, on 22nd, 24th and 27th February 1927 and on 13th March 1937 (Boyd, 1937). There were 3 at Cheddar Reservoir, Somerset, on 14th February 1950, one of which was seen quartering a ploughed field for food and returning to the reservoir to drink; all were dead by 26th February (King, 1950). There was 1 dead at Hurst Castle, Hampshire, on 21st February 1951; this bird was very thin and when it was opened five pieces of rubber band were found in the stomach (Crook and Goater, 1950). In January and

February 1956 there was a small-scale wreck on part of the Caernarvonshire coast (Archbold, private communication). In November 1956 2 adults were recorded from an inland loch in Berwickshire (Patterson, private communication).

Between 1928 and 1956 wrecked Kittiwakes have been recorded in 17 different years in Somerset. Generally only small numbers occur, but larger numbers were recorded in March 1954 and February/March 1955. On the latter occasion 36 birds were seen alive or subsequently found dead (R. H. Poulding, private communication).

R. H. Poulding has carried out post-mortem examinations on 11 Kittiwakes which were wrecked between 1950 and 1957. One of these birds was found in Somerset in December, all the others during February, March or April, in Somerset, Gloucestershire or Lincolnshire. All showed signs of starvation.

There are also well-documented accounts of small-scale wrecks of Kittiwakes on the continent of Europe and it is rather surprising that the British Isles were not affected on these occasions. In Switzerland single birds occur most winters; exceptionally large flocks were recorded in February 1806, March 1818, February 1860 and, more recently, in November/December 1954 and February/March 1955. The 1954-55 wreck followed on a period of westerly gales in the Atlantic (Sutter, 1956) and it also affected Northern Germany (Seilkopf, 1955). Seven birds from this wreck were weighed and it was found that the birds had lost an average of 42% of the normal body weight; even the earliest arrivals were underweight and starving.

A large wreck of Kittiwakes occurred in Sweden and Finland in March 1927 (Välikangas, 1930; Lönnberg, 1927). Small wrecks, generally only of single birds or very small parties, were reported from Luxemburg during the winters of 1870, 1896, 1937 and 1957 (Hulten, 1957).

#### DISCUSSION

The wreck of February/March 1957 appears to have been the first of its kind in the British Isles, although, as has been noted above, similar wrecks, on a smaller scale, have been reported from other countries of Europe.

Seilkopf (*loc. cit.*) and Sutter (*loc. cit.*) have shown how wrecks in Germany and Switzerland can be correlated with Atlantic weather conditions and in this present case there can be little doubt that the wreck was caused by the persistent westerly gales which swept the Atlantic during the preceding weeks. It is possible that the north-westerly and south-westerly gales in the west Atlantic helped to concentrate the birds in the mid-Atlantic area, from which they were carried across to the British Isles.

Boyd (1953) has pointed out, in connection with the wreck of Leach's Petrels (*Oceanodroma leucorhoa*) in the autumn of 1952, that it is not the severe gales of short duration that cause the greatest damage to oceanic birds, but "a persistence of winds" of sufficient strength to carry the birds away from their normal feed-

ing grounds and on to a lee shore. All airborne Kittiwakes during the period under discussion must have been steadily carried westwards by the gales and there were insufficient periods of calm to enable them to return to their normal wintering area.

During such gales birds cannot gain protection or maintain their position by resting on the surface of the water. In high winds at sea, spray is blown off the crests of the waves continually and, according to Wynne-Edwards (1953), small birds are also whipped off and carried steadily downwind. Presumably Kittiwakes can also be affected in this way, especially if they have already been storm-driven and are underweight or exhausted.

All the large flocks of Kittiwakes appeared on the south, west and south-west coasts of the British Isles and they appear to have reached the different parts of the coast at approximately the same time. This would indicate that the birds were in fact storm-driven and were not taking part in a normal passage migration parallel to the coast. Birds recovered on the Irish coast and on the Isle of Man may have been carried up the Irish Sea on a south-west wind or they may have moved down through the North Channel. The former seems the more probable and it is supported by the occurrence of corpses at Waterford and Dublin and all along the Welsh coast and by the absence of corpses from the shores of Wigtown and Ayr.

The only flocks found on the east coast of England were the 12 birds at Spurn Point, Yorkshire, and the 6 at Southend-on-Sea. These birds may have made their way across England or they may have been carried up the English Channel.

The inland records presumably represent the final dispersal of the birds over the British Isles. There is a steady decrease in numbers towards the east of the country; evidently many of the birds made their way inland in search of food but died before they got very far.

The evidence suggests that many, if not all, of the birds were starved and underweight when they reached the British Isles. It is difficult to decide whether the birds were starving because they had been storm-driven, or whether they had been unable to maintain their normal position in mid-Atlantic because an interruption in their normal food supply had left them weakened and at the mercy of the gales. When the birds had reached this country few were in a condition to attempt the journey back; many died immediately, others managed to survive for a few days or weeks, picking up food along the shore, or at inland reservoirs or in the fields. Kittiwakes do not normally feed on the shore in this country, but, according to Bent (1921), they feed to some extent on beaches and sand-flats at low tide in America and it is possible that some of the wrecked birds did manage to find enough food in this way to enable them to survive. Many of the birds, however, fed on poisonous substances, or picked up infestations of parasitic worms or other pathogenic organisms and soon died. There can be little doubt that the vast majority of the birds died of starvation.

The loss of liver weight and body weight, the absence of subcutaneous fat, the muscle wasting and the evidence of the histological examination all indicate that the birds had been drawing heavily on their bodily reserves of fat and glycogen. Birds which found alternative food supplies also died; presumably they were unable to cope with a diet to which they were not adapted or else their bodily reserves were already depleted to below a level from which recovery could be made. Once the carbohydrate reserves of the body have been used and fat is mobilized as the energy source there is likelihood of death occurring as the utilisation of fat by the body liberates toxic waste products such as ketone bodies.

The various pathological conditions described in the post-mortem reports are of interest but do little to throw light on the cause or the widespread nature of the wreck. In view of the large number of parasites normally carried by healthy birds it would be unwise to assume, without very definite evidence, that any of the organisms listed were primarily responsible for death, although there can be little doubt that they were a contributory factor, especially as the birds were already weakened by starvation.

Although there is sufficient evidence to suggest that these wrecks are caused by gales in the Atlantic, we still do not know why a wreck is more likely to occur in one year than another. The 1957 Kittiwake wreck appears to have been the first of its kind in this country; the 1952 Leach's Petrel wreck was the second one to have occurred in 60 years (Boyd, *loc. cit.*) and in both instances only the one species was involved in the wreck. Why were there no Kittiwakes wrecked in 1952, why no Leach's Petrels in 1957, and in both cases why no other sea birds?

It would appear, however, from the evidence of the isolated records of storm-driven Kittiwakes and the early Continental wrecks, that small-scale wrecks do in fact occur more frequently than has been suspected, but it is very probable that most of the birds killed or weakened by prolonged gales are used as food by the larger carrion-feeding gulls and do not reach the western shores of the Atlantic. Duffey (private communication) gives the information that Kittiwakes have a very patchy distribution in the North Atlantic and it is probable that it is only when a fairly large flock, in this particular case a minimum of 1,000 birds, occurs in the direct path of a storm centre that a noticeable wreck occurs on our shores.

#### APPENDIX I—DETAILS OF THE DISTRIBUTION OF KITTIWAKES (*Rissa tridactyla*) IN THE BRITISH ISLES IN EARLY 1957

(The reports are arranged under counties in vice-county sequence.)

##### A—Coastal flocks

This list includes all the flocks and all the instances of a large number of corpses; such records were almost entirely confined to coastal areas. Any group of more than 5 birds has been considered as a flock. The distribution of the flocks is shown in Fig. 1.

## CHANNEL ISLANDS

*Jersey*: The main influx occurred between 16th-27th February. Weak birds started appearing on 16th February and the first corpses were found on the 18th; by the 24th, 21 corpses had been found and after this date the numbers dropped rapidly. It is probable that in fact a great many more corpses were present; many people reported having gathered and buried or burned numbers of dead birds.

## ENGLAND AND WALES

*Cornwall*: Kittiwakes first appeared on 4th February, when 2 corpses were found on a beach in south Cornwall; on 5th February 10 birds were present, and on the 6th one was a few miles inland. Between 14th and 26th February Kittiwakes were present in Fowey Harbour, where they were quite tame and accepted food with the Herring Gulls (*Larus argentatus*). 3 were present on 14th February and 20 on the 15th. Numbers then fell off until the 26th when only 2 remained. Several of the birds were later found dead; one was handed for several days until it died.

*Devon*: On 18th January one bird was found dead, and another exhausted bird was picked up on 7th February. On 9th February 35 living birds and 4 corpses were seen near Exmouth. On the same date a flock of 60-70 Kittiwakes was seen at Wembury, resting in a ploughed field and feeding on earthworms. 5 birds were present at Plymouth on 2nd February and these had increased to ca. 100 by the 11th. From 10th to 25th February a flock of 15 was seen around the Yealm estuary; all were in a weak condition and many of them died. On 24th February 15 living birds and 6 corpses were seen near Wembury. During this period solitary birds were seen at various parts of the south coast until 9th March. At Morte Point on the north coast 17 living birds were seen on 10th February.

All told, 271 birds were reported from this county.

*Somerset*: The first Kittiwake recorded arrived at Minehead on 28th January; others were seen alive there on 10th February, and a total of 85 between that date and 24th February. One bird was still alive on 10th March. 3 corpses were found on 10th February and corpses continued to appear until 11th March; in all, 85 corpses were recorded. Most of these records are for the coast. A few single birds were found inland and flocks were seen at Tealham Moor floods and in the vicinity of Cheddar Reservoir on 24th February; 56 corpses were found in this inland area between 16th February and 11th March.

*Dorset*: On 13th February 15-20 birds were seen close inshore; some were slightly oiled, but none was badly affected; they were still there on 25th February. Single birds were also present in Swanage Bay during January and February.

*Hampshire*: The greatest concentration of Kittiwakes occurred in this county. Single birds or small groups of 2-3 birds were present at Hayling Island, Portsmouth Harbour, Langstone Harbour and Southampton Water and the Solent during the whole period of the wreck, from early February until mid-March. Very large flocks, totalling about 150 birds, were seen along the shore between Southbourne and Bournemouth on 10th February and a flock of 40 at Hurst Castle on the same date. Local observers thought that a slight westerly movement was taking place along the coast. By 17th February the numbers had dropped to about half of those present in the previous week, though the birds were still very plentiful and the number of corpses had increased. Many of these birds showed traces of oil on the plumage.

There was a considerable amount of overlapping and duplication of reports from this area, but even the most conservative estimate shows that a minimum of 320 birds was present\*. In the equivalent weeks of 1956 no Kittiwakes, dead or alive, were seen in this area.

---

\*Records from the Isle of Wight were received too late for inclusion here or in Fig. 1: between 3rd February and 2nd March 31 birds were reported from various parts of the island and 12 of these were oiled; most were definitely identified as adults (*per* J. Stafford).



*Sussex*: In early February about 30 Kittiwakes, which were very tame, appeared at Brighton and Newhaven. They remained for some weeks feeding on the roads and piers and roosting at night on a building near one of the piers. Scattered corpses were also found along the shore between 4th February and 6th March.

*Essex*: On 2nd February 6 Kittiwakes were reported circling at the end of the pier at Southend-on-Sea; they remained in the area for some time, feeding and resting on the life-boat station roof and on the launching ramp. Between 3rd February and 24th March 5 corpses were found.

*Glamorganshire*: On 3rd February 11 dead birds were found on the Gower coast and from then until 6th March corpses turned up regularly. 91 dead birds were found, and there were additional reports of 15 oiled birds.

*Cardiganshire*: Flocks appeared first in the harbour at Aberystwyth in the beginning of February. The first corpse was found on 12th February and corpses were then found in increasing numbers until 16th February when 10 were found. The numbers then dropped off again, and the last corpse was found on 18th February. A few corpses were also picked up on the beaches a few miles from Aberystwyth and the indications were that they too had died during the period 12th-18th February, but it was difficult to date them more accurately than this. Altogether about 40 corpses were found.

*Caernarvonshire*: In early February 30 dead birds were found near Pwllheli. On 14th March many weak birds were still present in the area, lying forwards on their breasts and showing signs of weakness.

*Cheshire*: Between mid-January and 16th February 5 corpses were found on the coast.

*Lancashire*: Many corpses were found on the shore, all in an emaciated condition. The first records were for 2nd February, and large numbers were found each week until 14th March, when the numbers had dropped to 7. A few living birds were reported about 17th February.

*Yorkshire*: 12 corpses were found at Spurn Point Observatory between the middle of February and early March. 2 corpses were found at Doncaster in early February and 6 corpses at Fairburn Marshes between 12th January and 23rd February.

*Cumberland*: No records are available for the critical period in February, but many decayed corpses were lying on the beaches in March.

*Isle of Man*: No weak or dead birds were seen on the island. A small flock of 6 juvenile Kittiwakes (apparently in good health) was seen in Peel Bay on 10th February.

## SCOTLAND

No large flocks of Kittiwakes were reported during January, February or March 1957.

## IRELAND

*Co. Dublin*: 13 corpses and 6 dying birds were found on the North Bull on 25th February.

*Co. Down*: Numbers of birds were seen at different parts of the coast in early February. On 12th February many dying birds were reported from Strangford Lough; corpses were found in this area until 22nd February, but after that date only healthy birds were noted. A flock of 30 was seen at Newcastle on 25th February. On another part of the coast 9 corpses were found on 17th February and 3 on 10th March.

On 16th December 1956, about four weeks before the wreck had affected any other part of the British Isles, a flock of 500 Kittiwakes was recorded at Ballyferis Point on the east coast of Ireland. These birds were "very skinny about the breast" and gradually all died.

## **B—Records of solitary birds or small groups, mostly inland**

The records of solitary birds cover a much greater area of the

British Isles than the foregoing records for flocks. Kittiwakes were reported from 26 counties in England and Wales, 6 in Scotland and 3 in Ireland.

#### ENGLAND AND WALES

*Wiltshire*: 1 dead Westbury, 30th March; 1 dead Wootton Bassett, 1st May.

*Sussex*: 1 dead Pagham, 3rd February; 1 dead Camber, 4th February; 1 alive Seaford, 17th February, died 20th February; 2 dead Chichester, 28th February; 2 dead Chichester, 6th March.

*Kent*: 1 dead East Malling Research Station, 16th February; 1 dead Deal, 25th February.

*Surrey*: 1 alive South Norwood Lake, 15th February, still there 20th February.

*Essex*: 1 dead Hanningfield reservoir, 24th February.

*Middlesex*: 1 dead Queen Mary reservoir, 17th February.

*Oxfordshire*: 2 dead Port Meadow, 2nd February; 3 dead Port Meadow, 3rd February; 2 dead Port Meadow, 4th February; 2 dead Port Meadow, 9th February; 1 alive River Thames near Nuneham Courtenay, 10th February; 1 alive Dorchester, 10th February; 1 alive Shotover Hill, 10th February; 2 alive Port Meadow, 16th February; 2 alive Port Meadow, 17th February; 2 alive Port Meadow, 23rd February; 1 alive and 5 dead Port Meadow, 24th February; 1 alive Port Meadow, 28th February.

*Suffolk*: 1 dead Orwell Haven, 10th February.

*Bedfordshire*: 1 alive Arlesey gravel pit, 24th January; 1 dead Bedford sewage farm, 24th February.

*Northamptonshire*: 1 dead Pitsford reservoir, 14th February.

*Gloucestershire*: 1 dead Rendcomb, 10th February; 1 dead Slimbridge, 16th February; 1 dead South Cerney gravel pits, 10th March; 1 dead (slightly decayed) Frampton-on-Severn, 31st March; 1 dead (very decayed) Frampton-on-Severn, 12th May.

*Herefordshire*: 1 dead Mathon, 19th February; 1 dead Mathon, 20th February.

*Worcestershire*: 4/5 alive Upper Bittell reservoir, 13th February; 1 weak near Dudley, 14th February, died 15th February.

*Warwickshire*: 1 dead (oiled) Castle Bromwich, 6th February.

*Shropshire*: 1 alive Ellsmere, 30th January; 1 dead Ellsmere, 11th February.

*Breconshire*: 1 alive Llandovery, 14th February, found dead 15th February.

*Montgomeryshire*: 1 dead Llanbryn-mair, 16th February.

*Caernarvonshire*: 1 dead Bethel, 8th March.

*Flintshire*: 3 dead Prestatyn, 27th and 28th February.

*Anglesey*: 2 dead (very decayed) Llanddwynn, 28th April.

*Nottinghamshire*: 3 dead Long Eaton, 25th February.

*Derbyshire*: 1 weak Ashbourne, 29th January, died 5th February; 1 dead River Trent, 10th February; 1 dead Sawley, 16th February.

*Lancashire*: 1 dead Blackburn, 10th February; 1 dead (oiled) Heysham harbour, 27th January; 5 dead Heysham harbour, 10th February; 1 dead Heysham harbour, 16th February.

*Yorkshire*: 1 dead Blackmoor Foot reservoir, 20th January.

*Westmorland*: 1 dead Kendal, 3rd March.

#### SCOTLAND

*Berwickshire*: 2 alive St. Abb's Head, 20th November 1956; 1 dead Primrose Hill Pond, 3rd February.

*East Lothian*: 2 dead on shore, 22nd February.

*Midlothian*: 2 dead Inchkeith Island, 28th February; 1 dead Inchkeith Island, 2nd March; 1 dead Inchkeith Island, 7th March; 2 dead Inchkeith Island, 10th March; 1 dead (slightly oiled) Figgate Pond, Edinburgh, 10th March.

*Fife*: 1 alive (died immediately) Crail, 2nd February.

*Perthshire*: 1 dead Strathtay, 10th February; 1 dead Strathtay, 3rd March.  
*Inverness-shire*: 1 alive Aviemore, 2nd February; 1 dead (same bird?), Kingussie, 12 February.

#### IRELAND

*Co. Down*: 1 (shot) Banbridge, 9th February; 1 dead Corbet Lake, 15th February.

*Co. Antrim*: 1 (shot) Stoneyford, 9th February; 1 alive Massareene Park, 16th February; 1 dead Lough Neagh, 17th March; 1 dead Shane's Castle, 24th March.

*Co. Derry*: 2 alive Derry harbour, 14th January.

### APPENDIX II—REPORT OF THE HISTOLOGICAL EXAMINATION OF TISSUES TAKEN FROM KITTIWAKES (*Rissa tridactyla*) COLLECTED IN THE BRISTOL AREA

(largely prepared by R. H. Poulding)

*Thyroids* (from 14 birds): Seven pairs showed colloid storage with predominance of colloid-filled vesicles. Five were active with little or no colloid storage and of these two showed marked proliferation of the follicular cells almost eliminating the follicular spaces. The remaining two were too autolysed for interpretation.

*Kidneys*: Four examined but no abnormalities found.

*Liver* (from 17 birds): The predominant feature was the disturbance of the normal liver pattern caused by shrinkage of the cells. Large amounts of intra- and intercellular pigment were present; most of it appeared to be haemosiderin, being strongly positive to the usual "Prussian blue" test for ferric iron. This iron positive pigment was in association with another pigment which, histochemically, was a lipofuscin. Lipids were also present in large quantities, so much so that the livers, on cutting, were greasy and the sections (frozen) floated on water. This lipid material stained bright red with Sudan IV in iso-propyl alcohol.

*Pectoral muscle* (from 15 birds): Loss of striation and patchy staining were the noticeable features. Frozen sections stained in Sudan IV showed fatty degeneration with each muscle fibre filled with minute globules of lipid.

No evidence of disease was found in any of the birds in the gross and from the material sectioned there were no microscopical pathological lesions.

#### ACKNOWLEDGEMENTS

I am particularly indebted to Mr. E. I. S. Rees and Mr. A. R. Angell who first drew my attention to the wreck and who assisted in the collection of information, especially in the South Wales area. The Department of Animal Pathology at Cambridge, the Ministry of Agriculture Veterinary Laboratories at Lasswade and Aberystwyth and the Public Health Laboratory at Plymouth carried out post-mortem examinations of corpses and sent in useful reports. R. H. Poulding made histological examinations of tissues from a number of corpses which had been collected and weighed by members of the Steep Holm Gull Research Station. J. A. Taylor helped with the interpretation of the meteorological data.

All the following sent in reports, answered my queries or helped to collect further information, and without their willing co-operation this survey could not have been made:

H. G. Alexander, A. Anderson, A. R. Angell, R. Angles, H. Archbold, J. D. Atkinson, R. H. Baillie, E. Balfour, Mrs. E. Barnes, T. H. Bell,

J. K. Bowers, J. V. Boys, T. E. Brice, K. Brown, R. Brown, A. Bull, Miss S. Bull, E. J. M. Buxton, J. Buxton, W. A. Cameron, Dr. J. W. Campbell, P. J. Chadwick, J. F. Chancellor, F. R. Clifton, G. E. Clothier, R. V. Collier, Rev. W. P. Corbishley, Mrs. J. B. Cowdy, J. M. Cullen, A. Cumber, G. C. D. Curtis, P. W. Davies, C. D. Deane, R. H. Dennis, D. F. Dorward, E. Duffey, F. J. Dyer, L. Eccles, G. S. T. Elliot, Miss P. Y. Fortune, P. J. Fullager, P. B. Gibbs, E. Giles, A. A. Goodheart, R. F. J. Greer, F. C. Gribble, H. J. Hambury, G. Harrington, D. A. Hawkins, A. W. Hennis, C. J. Henty, J. A. Hinks, Miss C. Hodgson, H. Holgersen, Miss K. Hollick, O. D. Hunt, Mrs. S. Hurd, R. J. Jackson, C. M. James, E. D. H. Johnson, P. Hope Jones, G. Kay, A. C. Kinchner, B. King, J. G. Leary, R. Lèvéque, D. R. Lees, Miss J. McNair, J. A. McGeoch, B. Murray, Mrs. J. R. Naish, J. F. Naylor, Miss E. M. Palmer, Mrs. M. Palmer-Smith, I. Patterson, D. B. Peart, R. Perry, N. Picozzi, R. A. Pitman, R. H. Poulding, G. A. Pyman, E. I. S. Rees, G. H. Rees, P. Roberts, W. L. Roseveare, R. F. Ruttledge, F. Salomonsen, T. B. Silcocks, D. Slay, D. J. Slinn, B. R. Smith, F. R. Smith, R. W. J. Smith, H. N. Southern, C. J. Stevens, B. Stonehouse, W. P. B. Stonehouse, C. Suffern, C. M. Swaine, Miss S. Sweet, Mrs. R. E. Teagle, W. G. Teagle, C. F. Unsworth, R. B. Warren, A. Watson, N. Webb, D. A. White, S. White, A. Williams, R. D. Wilson, C. Winn, J. Wright, M. A. Wright, Professor V. C. Wynne-Edwards, Miss H. Zutt.

## REFERENCES

- ALEXANDER, H. G. (1924): "Birds on a North Worcestershire reservoir 1922 and 1923". *Brit. Birds*, xvii: 292.
- BENT, A. C. (1921): *Life Histories of North American Gulls and Terns*. Washington. p. 40.
- BOYD, A. W. (1926): "Kittiwakes inland in Cheshire". *Brit. Birds*, xx: 56.
- (1931): "Notes from Staffordshire reservoirs". *Brit. Birds*, xxvii: 271.
- (1937): "Kittiwakes inland in Cheshire". *Brit. Birds*, xxxi: 63.
- BOYD, HUGH (1953): "The 'wreck' of Leach's Petrels in the autumn of 1952". *Brit. Birds*, xlvii: 137.
- CROOK, J. H. and GOATER, B. (1950): "Rubber in the gizzard of a Kittiwake". *Brit. Birds*, xlii: 382.
- HULTEN, M. (1957): "Zum Erscheinen der Dreizehenmöwe (*Rissa tridactyla*) in Luxemburg im Februar und März 1957". *Regulus*, 37 (4): 75.
- JOUANIN, C. (1957): "L'irruption en France de Mouettes Tridactyles en Février 1957 (1)". *L'Oiseau*, xxvii: 363.
- KING, B. (1952): "Storm driven Kittiwakes quartering the ground in search of food". *Brit. Birds*, xlv: 38.
- LÈVEQUE, R. (1957): *Rissa tridactyle à Paris*". *Alauda*, xxv: 71.
- LÖNNBERG, E. (1927): "En katastrof for stormdrivna tretåiga måser, *Rissa tridactyla*, i norna Sverige. *Fauna och Flora*, 1927: 155.
- MOXON, P. (1942): "Kittiwake in Derbyshire". *Brit. Birds*, xxxvi: 40.
- RANKIN, M. N. and DUFFEY, E. A. G. (1948): "A study of the bird life of the North Atlantic". *Brit. Birds*, Special Suppl. to xli: 1.
- SELKOPF, H. (1955): "Zu den Einflügen der Dreizehenmöwe (*Rissa tridactyla*) im Winter 1954/55 im europäischen Festland". *Die Vogelwarte*, 18: 34.
- SOULSBY, E. J. L. and JENNINGS, A. R. (1957): "A new species of coccidium (*Eimeria rissae* n. sp. Eimeriidae, *Sporozoa*) from the Kittiwake, *Rissa tridactyla tridactyla* (L.)". *Nature*, 180: 1057.
- SUTTER, E. (1956): "Über das gehaufte Auftreten der Dreizehenmöwe in der Schweiz im Winter 1954/55". *Orn. Beob.*, 53: 81.
- WYNNE-EDWARDS, V. C. (1935): "On the habits and distribution of birds in the North Atlantic". *Proc. Boston Soc. Nat. Hist.*, 40: 233.
- (1953): "Leach's Petrels stranded in Scotland in October-November, 1952". *Scot. Nat.*, 64: 167.
- VÄLIKANGAS, ILMARI (1930): "Eine *Rissa t. tridactyla* (L.) invasion nach Finnland im März 1927 nebst einigen Bemerkungen über das frühere Auftreten dieser Art und ihre Zugverhältnisse". *Ann. Soc. zool.-bot. Fenn. Vanama*. Helsinki, 10: 227.

# MORTALITY OF KITTIWAKES DURING THE BREEDING SEASON

By LEONTIA McCARTAN

(Department of Zoology, University College of Wales,  
Aberystwyth)

In connection with the survey of winter wrecks of Kittiwakes (*Rissa tridactyla*) (see pp. 253-266) it is of interest to note that several instances of mass mortality have occurred in recent years during the weeks when the Kittiwakes are on the breeding cliffs.

In May and June 1955 there was a heavy mortality in a breeding colony near Pennan Bay, north Aberdeenshire. The birds were watched for some time turning over and over in the water and floating on their backs, and eventually some were washed up dead on the shore (Mrs. J. B. Cowdy, private communication). None of these corpses was examined, and the cause of death is a matter of conjecture. At about the same time 120 dead Kittiwakes were picked up on the shore at Stonehaven, south of Aberdeen, and investigation showed that those examined had died from a heavy infestation of *Aspergillus fumigatus* (A. Anderson, private communication). All the birds in both cases were adults.

In mid-May 1957 70-80 corpses of adult Kittiwakes were found on the East Lothian shore between Aberlady and Dunbar (R. W. J. Smith, private communication). 2 corpses were sent for examination at Lasswade Veterinary Laboratory, and it was reported that both birds were slightly underweight but that it was "impossible to give the cause of death".

Evidence as to the cause of death is lacking in two of the instances, but at a time when the birds are crowded together on the breeding cliffs an epidemic could sweep through the colony in a way that would not be possible when the birds are widely dispersed over the winter feeding area. H. N. Southern (private communication) suggests that the habit of communal bathing in fresh-water lochs near the breeding cliffs may assist in the spread of disease.

All the birds concerned in the mass mortalities discussed so far were adults. The circumstances in the recorded cases of mass mortality of juveniles appear to be somewhat different.

Many juvenile Kittiwakes were found dead in August 1956 at Eynhallow in the Orkneys (A. Anderson). E. Balfour (private communication) counted 250 corpses, "all juveniles and the majority fully fledged", in the vicinity of Marwick Head at this time. A similar mortality occurred in August 1957. One report stated that "thousands of corpses were found on the sandy shores of Westray and West Orkney". E. Balfour visited Marwick Head on 7th August and found 280 corpses, all juveniles. In both

years the freshly dead bodies were "nothing but skin, bone and feathers". A third instance has been reported by G. T. Kay, who has written to say that there was a heavy mortality in Shetland about 25 years ago: many juveniles were found, on the shore of the loch of Clickimin; all, apparently, were in perfect condition, but none could fly, and when they were picked up they were found to be "literally skin and bones".

In each of these instances of juvenile mortality starvation appears to have been the cause of death. 11 corpses were examined at Lasswade in 1957 and it was found that in every case the crop and gizzard were empty and the intestinal contents practically nil. All the internal organs had atrophied. One bird had aspergillosis affecting the right abdominal air sac, but none of the others showed any signs of specific diseases; the bacterial examination was negative and internal parasites were not present in significant numbers. The heaviest of these birds weighed 249 gm., the lightest 177 gm., and the average weight was 216 gm. The results of this examination strongly suggest that the birds died of starvation, and this idea is supported by the fact that the juveniles which were rescued at the time of the Shetland wreck recovered after a few days' feeding.

The suggestion has been made by the Lasswade Laboratory that as all the other sea birds in the area remained healthy, and as there was no evidence of disease in the older Kittiwakes; the only possible reason for death would be starvation brought about by a larger than usual hatch of Kittiwakes or by a failure in the normal food supply.

There are no records of mortalities on a similar scale at the Kittiwake colonies on the Durham coast and on the Farne Islands, which have been intensively studied by J. C. Coulson and E. White and by E. Cullen respectively. Cullen (1957) has shown that food may, to a certain extent, limit the number of young raised: there is asynchronous hatching and a definite peck-order is quickly established among the chicks. But food shortage as a controlling factor would presumably only operate during the period prior to fledging, when the parents are still feeding the young, and not after the juvenile plumage has been acquired and the young are able to feed themselves.

In the present state of our knowledge it is difficult to say more about the cause, meaning or possible effect of these breeding season mortalities, whether affecting adults or juveniles, but it will be interesting to watch for similar occurrences during future breeding seasons, and to see whether they can be correlated with any factors which control the population of Kittiwakes and their food supply.

#### REFERENCE

- CULLEN, ESTHER (1957): "Adaptations in the Kittiwake to cliff-nesting". *Ibis*. 99: 2.



John Warham

FRIGATE PETREL (*Pelagodroma marina*) EMERGING FROM BURROW: LANCELIN ISLAND, W. AUSTRALIA, 1954  
This species is distinguished from all other small petrels by its completely white under-parts which contrast with its dark grey upper-parts. This plate shows well the pattern of the head, with the white on the forehead extending backwards to form a white stripe over the eye. The wings and a broad terminal band across the tail are black, and the upper tail-coverts pale grey (see page 269). The sexes are alike and both incubate, alternating in spans of 3-5 days; the incubation period is 7-8 weeks.



John Warham

FRIGATE PETREL (*Fregata aedon*) WALKING: LANCELIN ISLAND, W. AUSTRALIA, 1954. A feature of this species is its remarkably long legs—black, with yellowish webs to the feet—which project beyond the tail in flight (see plate 44). Frigate Petrels are burrowers, excavating their tunnels in the usually soft and often sandy ground of their chosen islands. Most tunnels are too small for a human hand and are 1½-4 feet long; the single white egg, usually sprinkled with pinkish spots at the blunt end, is laid on a mat of grasses or leaves (see page 270).





John Warham

FRIGATE PETREL (*Pelagodroma marina*) RETIRING AFTER DARK: LANCELIN ISLAND, W. AUSTRALIA, 1954  
 On this island the burrows were about 4 feet long and  $\frac{1}{2}$  foot deep, and had most of their entrances hidden by pigface (*Carpobrotus*) or stunted scrub; these birds appear to prefer to delve beneath dune plants in this way. It is, however, common to find eggs laid above ground by females unable to obtain burrows. Like most petrels, this species is nocturnal on land and these photographs were taken after dark in October and November (see page 271). Note again the white face divided by the dark stripe below the eye.



*John Warham*

FRIGATE PETRELS (*Pelagodroma marina*) IN FLIGHT

LANCELIN ISLAND, W. AUSTRALIA, 1954

From below, these birds are wholly white except for the dark flight quills and tail. Note the way the long legs project beyond the tail; these are dangled when the bird patters across the surface of the water. The flight is fast but rather feeble. In these photographs the black beaks, in contrast to the yellow-webbed feet, are lost against the night sky.

# PHOTOGRAPHIC STUDIES OF SOME LESS FAMILIAR BIRDS

## XC. FRIGATE PETREL

Photographs and text by JOHN WARHAM

(Plates 41-44)

ACCORDING to *The Handbook* two specimens of the Frigate Petrel (*Pelagodroma marina*), or White-faced Storm Petrel as it is called in the regions where it breeds, have occurred in Britain. One was found dead at Walney Island, Lancashire, in November 1890, the other caught alive at Colonsay, Inner Hebrides, on 1st January 1897. Both these birds belonged to the race *hypoleuca* which nests on the Salvages, the Cape Verdes and the Canary Islands in the north Atlantic.

The Frigate Petrel is easily distinguished from the other small petrels on the British list, such as Wilson's Petrel (*Oceanites oceanicus*) by being white below and dark grey above. The tail in the race *hypoleuca* is rather square-cut as also obtains with the Australian race *dulciae* illustrated here. The wing quills and a broad terminal bar across the tail are black, the upper tail-coverts being pale grey. The forehead is white and this extends backwards to form a wide white eyebrow line. Seen from below the bird is wholly white except for the dark flight quills and tail. Strong sunlight may give the upper-parts a brownish cast, but there is no wing stripe. At close quarters the remarkably long legs which project a little beyond the tail, may be seen. The legs are black, the webs yellowish and the bill black. The sexes are identical in appearance.

At sea this tiny bird has a wavering flight and the long legs are dangled when the bird patters across the surface. Unlike Wilson's Petrel the present species does not normally feed in the wake of ships and even in the vicinity of its Australian breeding grounds it is only infrequently seen out at sea. In the hand the bird is very docile and makes no attempt to peck. It weighs about 2 ounces. The food consists of surface plankton and Euphausiids; small squids, barnacle larvae, sea-fleas and prawns have been found in stomachs.

The several races of this petrel have been reviewed by Murphy and Irving (1951) and by Bourne (1953). The first authors admit *P. marina marina* from Tristan da Cunha, *P. m. hypoleuca* from the north Atlantic islands, *P. m. dulciae* from Australia, *P. m. maoriana* from New Zealand, the Chatham and Auckland Islands and propose a new sub-species *albiclunis* for the Kermadec birds. Bourne amended these groupings, but he now tells me (*in litt.*) that as a result of further study he feels that "all races ill defined,

do not accept exacting criteria; if any are accepted probably best to recognize all of them”.

Like most petrels the Frigate Petrel repairs to islands when breeding and is nocturnal on land. Most birds breed in the summer and in Australia and New Zealand reappear on the nesting grounds in October and November. At Tristan da Cunha the position is obscure, but Elliott (1957) thinks that it is probably a very early summer breeder there also. At the Canary and Madeira Islands in the north Atlantic the species also breeds in the (northern) summer, but on the Cape Verde Islands near-by it is a winter breeder, returning in early November to lay its eggs in February (Bourne, 1955). These north Atlantic colonies are believed by Bourne (1957) to have had a southern origin, having entered the area after a deterioration in climate at the end of the Pleistocene, and this author suggests that these colonies are relicts isolated by a subsequent climatic warm-up which has made possible the development of summer-breeding populations in the Madeira and Canary groups and a sub-tropical winter breeding population at the Cape Verde Islands.

Frigate Petrels are burrowers. They excavate tunnels in the usually soft ground of their chosen islands. Most tunnels are just too small to admit a human hand, are from 18 inches to 4 feet long and may be straight or twisting. On Grande Salvage Lockley (1952) found many burrows in hard soil only 3 to 9 inches down, but most seem to be made in rather sandy situations and perhaps because roots help to prevent entrances from silting up and roofs from collapsing, the birds appear to prefer to delve beneath creeping dune plants like iceplant and pigface (*Carpobrotus*), bower -spinach (*Tetragonia*) and climbing lignum (*Muehlenbeckia*).

The single white egg is laid on a fine mat of grasses or leaves and in sandy situations does not become badly stained through contact with the ground as do the eggs of most burrowing petrels. It seems probable that once an island has been used by a bird as its breeding place it resorts to it for the rest of its life: 8 breeding adults ringed on 28th January 1955 at Port Kembla, New South Wales, were recovered on 3rd November 1956 breeding at the same place (Carrick *et al.*, 1957).

Although the islands of southern Australia house many thousands of Frigate Petrels and banding of birds started there as long ago as 1914 (Campbell, 1933), the only detailed studies of the breeding biology are those of Richdale (1943, 1944) in New Zealand on the race *maoriana*, and it is from Richdale's papers that most of the following details have been extracted.

Both sexes sit, incubation spans being mostly from 3 to 5 days but they may be as long as 9 days. As obtains with other petrels, eggs may be deserted for a day or two and yet hatch successfully. There are always a lot of unemployed birds at the rookeries, at least during the earlier part of the breeding cycle, and surface

eggs, probably laid by females unable to obtain burrows, are common. Such eggs are not incubated but are devoured by gulls, skuas, reptiles and the like. Such surface eggs, although white-shelled, may be almost translucent and have a pinkish tinge when held to the light. Most eggs are finely sprinkled with pinkish spots towards their blunt end. In New Zealand the incubation period lasts between 7 and 8 weeks, hatching taking place between 20th December and 31st January, reaching its peak between 30th December and 10th January. A similar timetable appears to apply at Australian rookeries of the species.

The chick has only one coat of down which is very long, hiding eyes and beak. Like the Storm Petrel (*Hydrobates pelagicus*) it has a bald patch on the top of the head, but this too is hidden by the down. At this stage the nestling looks like a light grey powder puff. Feathering on the scapulars begins on the 9th day, and by the 8th week the down has almost gone.

Although both parents normally brood the chick at least once, it is abandoned by day at 2 to 4 days old. From then on it is fed by one or sometimes both of the parents on 4 nights out of 5. The method of feeding has not yet been described; doubtless the chick takes its food from the adults by inserting its beak inside and at an angle to that of the parent and thereby diverts the food down its own gullet in a manner comparable with that of shearwaters and albatrosses. The chick's peak weight of 65 gm. (it weighs 9 gm. at birth) is reached at 33 to 36 days when it is still quite downy. Feeding and attendance at the rookeries seems to be retarded by bright moonlight nights. There may be a short fast period before the chick leaves for the sea, but Richdale believes that what usually happens is that the chicks depart during a gap in feeding visits and this would explain why adults may be found at nights in their burrows after the young have departed. A similar procedure appears to take place with some other southern petrels and even with the Australian Gannet (Warham, *in press*).

The photographs reproduced here (plates 41-44) were taken on Lancelin Island, Western Australia, in October and November 1954 and depict the race *dulciae*. On this island these petrels nest in sand where their burrows were about 4 feet long and about 1 foot 6 inches deep, having most of their entrances hidden below pigface or stunted scrub. At night the birds appeared only after dark, flying along the slopes silently "like huge long-legged flies" to use Lockley's apt simile. They were prone to be attracted by lights and several settled on the ground in a pool of light thrown by our tent lamp. Their flight was fast but rather feeble, surprisingly weak for a race that is now known to winter in the Arabian Sea and northern Indian Ocean (Bourne, 1953). Owing to their nocturnal habits the birds seemed to have few enemies on this island and no corpses were seen lying around. Natural enemies do exist, however, and birds like Pacific and Silver Gulls (*Larus pacificus* and *L. novae-hollandiae*) and Southern Skuas (*Catharacta*

*skua*) take eggs, adults and chicks when they get the chance at some of the Australian and New Zealand breeding stations.

The voice of this small petrel has been variously described: "not unlike that of a Redshank (*Tringa totanus*) heard at a distance" (Loekley, 1952), "a low, frisky 'chee-ur'" (Campbell, 1933) and so on. On Lancelin Island the main call, heard only from birds on or below ground was a mournful "wooo" repeated about once per second or expanded into a siren-like moaning, "oooooooooooo". Occasionally burrow-bound birds gave voice in broad daylight. As on Whero Island where Richdale made his observations, we found that the birds were less numerous on moonlight nights and Campbell's notes suggest that those that do come in on bright nights to feed their chicks depart again soon afterwards whereas on dark ones their departure is delayed until an hour or so before dawn.

#### REFERENCES

- BOURNE, W. R. P. (1953): "On the races of the Frigate Petrel, *Pelagodroma marina* (Latham)". *Bull. Brit. Orn. Cl.*, 73: 79-82.
- (1955): "The birds of the Cape Verde Islands". *Ibis*, 97: 508-556.
- (1957): "Additional notes on the birds of the Cape Verde Islands with particular reference to *Bulweria mollis* and *Fregata magnificens*". *Ibis*, 99: 182-190.
- CAMPBELL, A. G. (1933): "The White-faced Storm Petrel". *Emu*, 33: 86-92.
- CARRICK, R., KEITH, N., and KEITH, K. (1957): "Third annual report of the Australian bird-banding scheme, July 1956 to June 1957". *C.S.I.R.O. Wildl. Res.*, 2: 145-163.
- ELLIOTT, H. F. I. (1957): "A contribution to the ornithology of the Tristan da Cunha group". *Ibis*, 99: 545-586.
- LOCKLEY, R. M. (1952): "Notes on the birds of the Berlengas (Portugal), the Desertas and Baixo (Madeira) and the Salvages". *Ibis*, 94: 144-157.
- MURPHY, R. C. and IRVING, S. (1951): "A review of the Frigate-petrels (*Pelagodroma*).". *Amer. Mus. Novitates*, No. 1506, pp. 1-17.
- RICHDALE, L. E. (1943-1944): "The White-faced Storm Petrel or Takahi-karemaona". *Proc. Roy. Soc., New Zealand*, 73: 97-115 and 217-232; 74: 335-350.
- WARHAM, J. (in press): "The nesting of the Australian Gannet, *Sula sarrator*". *Emu*.

## THE MOULT MIGRATION OF THE SHELDUCK FROM CHESHIRE IN 1957

By R. H. ALLEN and G. RUTTER

IN 1957, observations were made for the eighth year in succession on the departure flights of Shelduck (*Tadorna tadorna*) from the River Mersey estuary at Weston, near Runcorn, Cheshire, and details are given in Table I. The moult migration in 1955 and 1956 has already been described in *British Birds* (*antea*, vol. xlix,

pp. 221-226; vol. L, pp. 344-346) and readers are referred to the map which was published with the first of these accounts.

The flights began earlier in 1957 than in the previous two years and during the last twelve days of June, in fine weather, 249 duck departed in 7 flights. Although the weather changed for the worse in July, favourable winds for flying persisted on most nights and there were departures of Shelduck except when there was rain or very low cloud. Of the total of 2,719 duck seen to leave the estuary in 1957, 886 went on 7 evenings when the conditions were dull and cloudy, 1,226 departed on 8 evenings when there was high cloud, and the remaining 607 left on 6 very fine evenings (in the recording of these departure flights allowance is, of course, made for any Shelduck seen to return).

TABLE I—DEPARTURES OF SHELDUCK (*Tadorna tadorna*) FROM WESTON, RUNCORN, CHESHIRE

Date	Number of flights	Number of birds in final departure flights	Total birds
19th June	2	38, 50	88
20th "	1	39	39
21st "	2	34, 21	55
27th "	1	47	47
28th "	1	20	20
1st July	3	12, 43, 24	79
5th "	3	42, 38, 12	92
10th "	6	63, 40, 27, 28, 49, 46	253
15th "	9	28, 40, 57, 73, 46, 24, 33, 42, 64	407
16th "	8	34, 16, 86, 65, 20, 54, 33, 26	334
19th "	11	36, 56, 32, 60, 14, 12, 25, 82, 64, 37, 42	460
20th "	1	42	42
21st "	2	8, 26	34
22nd "	1	86	86
24th "	6	57, 56, 48, 32, 28, 34	255
26th "	3	6, 62, 56	124
28th "	2	24, 56	80
29th "	1	56	56
30th "	3	42, 35, 38	115
31st "	1	25	25
1st August	1	28	28
Totals	68		2719

With the assistance and co-operation of members of the Merseyside Naturalist's Association, we attempted a census of all adult and first-summer Shelduck on the River Dee, by means of simultaneous counts at strategic points on both banks. This took place on 30th June, and also included counts on the River Mersey and Rivers Clwyd and Conway in North Wales. The resulting totals were 475 on the Dee, 161 on the Mersey and 60 each on the Clwyd and Conway. The grand total of 756 may not be absolutely accurate, but it gives a general idea of the number of Shelduck in the area.

Compared with the numbers seen on the Dee and Mersey on 1st

and 2nd July 1956 (*antea*, vol. L, p. 346), this was a decrease of approximately 36%; even allowing for the unusually early departures before 30th June in 1957 (totalling 249 birds), the number present was down by 115, or 11½%. In view of this, it was surprising that the total of 2,719 departures in 1957 represented an increase of over 33% on the previous year's figure of 2,036. It is possible, of course, that a number of the Shelduck seen to depart from the Mersey may make their way back to it unnoticed and thus be recorded twice.

Repeating their visit to Tintwistle and the Longendale valley in the hills of east Cheshire, which was considered a likely route for the migrating Shelduck (see *antea*, vol. L, 346), R. Walton and R. H. Allen waited at the reservoirs there on 19th July from 7.30 p.m. (G.M.T.) till dusk. It was misty about the hills and visibility was limited. Although 420 duck left the Mersey that evening none was seen in the valley, but they would only have been observed had they passed directly overhead.

Inland flights were observed, however, on 5th July at Heald Green (22 miles E.N.E.) and Altrincham (17 miles N.E.): at the former locality 37 birds were seen (R. and I. M. Walton) and at the latter there was a flight of 49 + 2 at 8 p.m., then another of 43 + 2 an hour later (S. Dobson); all were heading eastwards. In addition, flights were recorded at Dutton (5 miles S.E.) on 10th, 15th and 16th July, 7 flights in all and a total of 300 birds (I. M. Walton).

The number of Shelduck on the River Mersey 28th July, as recorded for the National Wildfowl Counts, was 260, excluding the young of the year. A month later, on 25th August, the total was only 73 and nearly all these were the by then full-grown juveniles. The recorded departures at Weston from 28th July to 1st August came to 304, and it is assumed that the excess over 260 was the result of an influx from the River Dee, or again possibly this could be accounted for by some birds making two departures and returning unseen in between.

In 1958 we intend to double-check the flight-departures from the Mersey by making additional observations at points within two miles of Weston.

#### ACKNOWLEDGEMENTS

The authors are indebted to A. W. Boyd for criticism and advice, and to the following who helped with observations: D. Arkle, G. D. Batt, R. C. Cockbain, E. M. Conder, R. E. Crabtree, C. J. Devereux, S. Dobson, K. Dorman, T. W. and Mrs. T. W. Ellis, E. Fowler, J. Groome, E. Hardy, S. G. Hopkins, A. M. Hughes, O. G. James, R. Riley, G. Thomason, R. Walton, I. M. Walton, T. Waring, M. Wyld.



## NOTES

**Magpie burying and recovering food.**—With reference to the note by Derek Goodwin on "Jays and Carrion Crows recovering hidden food" (*antea*, vol. xlvi, pp. 181-183) and other comparable observations, a note on this habit in the Magpie (*Pica pica*) may be of interest. Magpies feed daily from a bird-table in my garden at Lightwater, Surrey, and have frequently been observed to carry food away to conceal it in rough ground either in the garden or on the adjacent heathland. On 5th February 1956, at about 10 a.m., one took a large piece of food—mixed mutton fat and rolled oats, light in colour and easy to see—from the bird table, flew down to some rough grass in front of a shrubbery in full view of the house, and quickly buried it, finally covering the place with a dead leaf or two. About three hours later a Magpie (probably the same bird to judge from its behaviour) arrived in the garden from some distance away (all Magpies come several hundred yards to feed here), flew at once to a small tree in the shrubbery, looked round for a few moments, then dropped to the ground about six feet away from the hiding place. Without hesitation it hopped direct to the spot, uncovered the food and flew off with it. The purposefulness of the whole action was most noticeable. R. W. HAYMAN

**Unusual nest of Song Thrush.**—On 12th April 1956, I found the nest of a Song Thrush (*Turdus philomelos*) in the Charnwood area of Leicestershire. This nest, which contained four deserted eggs, was placed upon a dead branch lying on the ground among briars and bracken, so that its top was only nine inches from the ground. More remarkable was the fact that the nest lacked any trace of the usual hard lining of cemented wood-pulp, etc., and contained no mud or earth in its make-up, but consisted only of twigs and grasses. *The Handbook* mentions no instance of nests of the nominate race lacking the hard lining, though nests of the Hebridean form (*T. ph. hebridensis*) are stated to do so sometimes. E. L. ROBERTS

[In 1936 I found a Song Thrush's nest in a rhododendron at Marbury, near Northwich, Cheshire, which was built of dead and skeleton leaves and little twigs, but had no hard lining at all. It held 4 eggs on 4th April 1936.—A.W.B.]

**Desert Wheatear in Essex.**—On 12th January 1958 I watched a male Desert Wheatear (*Oenanthe deserti*) at East Mersea, Essex. It was first seen at about 12.15 hours and was feeding along the foot of a low cliff (4-20 feet in height) among slabs of fallen earth and concrete and scattered tree trunks on shingle and sand at the mouth of the River Colne. A cold westerly wind was blowing, but the bird was sheltered at the foot of the cliff. It was remarkably tame, allowing me to approach within 10-15 yards, and I was able to obtain the following description:

Crown and nape very pale fawn; back rich sandy brown; sides of face, cheeks and throat black with some whitish speckles, particularly on the throat; a pale whitish stripe over the eye; breast sandy and the remainder of the under-parts off-white. The tail was black almost to the rump, and

the absence of the white outer-feathers so conspicuous in *Oe. oenanthe* was very noticeable, particularly when the bird fanned its tail as it landed on the stump of a tree. The wings appeared to be black at a distance, but on closer observation the primaries and secondaries were seen actually to be very dark brown, though there was some black on the wing-coverts near the wrist; the lesser and median coverts were rufous-brown; at close quarters small speckles were apparent on the wing-feathers; the underwings were not clearly seen, but in flight appeared to be dark. Bill and feet dark (? black). Size as *Oe. oenanthe*.

The colouring of the wings suggested a first-winter bird.

Occasionally it made short, darting flights into the air to catch passing insects, and at one point it had a short squabble with a Robin (*Erithacus rubecula*), when it uttered the only note heard, a harsh "tchuk". I watched the bird continuously for nearly half an hour, then intermittently for the next hour; it was still present when I left at 14.00 hours. The following day, 13th January, Mr. R. V. A. Marshall visited the site and saw the bird for a few minutes before it disappeared among some scrub on the shore: he was able to confirm the identification and his description agreed with mine.

During the next two weeks a number of people searched for the bird without success, but it was seen again on 3rd February by L. G. Temple.

B. A. B. BARTON

**Goldcrest caught on hooks of burdock.**—Two Goldcrests (*Regulus regulus*) had been on the Isle of May for several days when, on 15th September 1957, I saw one of them fluttering round and round a burdock (*Arctium vulgare*) calling excitedly. As I came near I found the second bird was entangled by two burrs. It struggled and relaxed, but only succeeded in drawing in a third burr. The wings and back remained free, but the soft ventral feathers were held firmly. It is doubtful if the little bird could have freed itself.

W. U. FLOWER

**Corn Buntings roosting in reeds.**—With regard to the notes on Corn Buntings (*Emberiza calandra*) roosting in reeds (*antea*, vol. xlii, p. 328; li, p. 126), perhaps I might draw attention to a passing reference in *The Birds of Lancashire* (1953) by Clifford Oakes, pp. 60-61: "An observation which may possibly refer to unmated females was made near Southport by F. W. Holder. Fully 200 birds were seen on 30th April, 1932, and a flock of 50, which kept together during May and June, roosting in a reed-bed, were certainly non-breeders."

K. G. SPENCER

## REVIEW

**BIRD STUDY IN A GARDEN.** By E. A. R. ENNION. (*Penguin Books*, "Puffin Picture Books", Harmondsworth, Middlesex, 1958). 31 pages; coloured and black-and-white illustrations by the author. 3s. 6d.

*Bird Study in a Garden* has been written with the intent of encouraging young bird-watchers to study the "common" birds

around their homes: a purpose so laudable that one would wish to be able whole-heartedly to welcome any book which commends it. But many of the problems suggested seem to be difficult for children of less than VIth Form age, for whom the book is avowedly intended: the solution of problems of ecological differentiation do call for a certain practice in the analysis or massing of data on reasonable bases—and usually for simple statistical testing as well. The explanation and discussion is (inevitably) much compressed: the statement that the “Law of Territory prevents birds of the *same* kind coming into competition” suggests that territorial practice is something imposed from without, and not simply an expression of competition in action. On many points of detail one may question the accuracy of the information given: a Song Thrush at work at an anvil is shown grasping the snail across several whorls in a widely-open bill, and the statement that the same species does not take “tree-fruit (except cherries) unless it has fallen to the ground” neglects the great quantities of growing yew-berries which are annually plucked by Song Thrushes.

The method of recording described in detail is by the use of symbols and dates upon area maps and “profiles”. Instruction is given in map-making, but not, unfortunately, in the measurement of the heights of trees, for which estimates are relied upon. The reviewer is compelled to admit that he finds the “garden profile” given, wherein an attempt seems to be made to combine a transverse section with an expression of the whole geography of the area, exceedingly hard to understand. A plain description of the essentials of an adequate entry in a note-book, with illustrations of tabular note-taking and simple graphical expression, might well be more valuable to the apprentice bird-watcher. P.H.T.H.

## RECENT REPORTS AND NEWS

By KENNETH WILLIAMSON and I. J. FERGUSON-LEES

**The items here are largely unchecked reports, and must not be regarded as authenticated records. They are selected, on the present writers' judgment alone, from sources generally found to be reliable. Observers' names are usually omitted for reasons of space and in case a report is subsequently rejected, and none of the items will be mentioned in our annual Index. Readers are asked to submit anything of interest as quickly as possible.**

### EMIGRATION OF JAYS

Our last summary closed with a paragraph concerning a movement of Jays (*Garrulus glandarius*) in coastal areas of Sussex, Hampshire and Dorset where this species is not normally seen (*antea*, p. 252), so it is appropriate to begin the present notes with a report from Portland Bird Observatory of a remarkable movement of Jays which took place on 11th May, when at least 24 birds were apparently emigrating. One trapped was a “very pink-

backed" bird. There was still a trickle of returning Blue Tits (*Parus caeruleus*) at Portland at the time (*antea*, p. 208). The previous report, from the Durlston Head area of Dorset, mentioned similar numbers of Jays each day from 10th-12th May, and it is interesting to examine the weather in which this exodus took place (Fig. 1-3). The movement began after the passing of a depression, when an anticyclone over the North Sea brought clear skies and light westerly breezes to southern England. The high was replaced on the 11th by a shallow depression, and a filling low arrived over Ireland on 12th; but despite these changes in the pressure-distribution, the wind remained light westerly at forces 1-3 and the sky was clear of cloud throughout. The only significant change in temperature was a fall which took place when the movement was already a day old—from 51-55°F. on the 9th-10th to 48-52°F. on the 11th-12th (midnight readings).

#### END-MAY PASSAGE AND AMERICAN WADERS

An Avocet (*Recurvirostra avosetta*) was seen at Farlington Marshes, Hampshire, by several observers from 10th-12th May—possibly the same as was present from 19th-28th April (*antea*, p. 207)—and on the 11th a Grey-headed Wagtail (*Motacilla flava thunbergi*) was found at a pond at Usworth, the first report of this race for Co. Durham. A Little Egret (*Egretta garzetta*) seen on the Hayle estuary, Cornwall, on 17th-18th May was probably the same individual as had been noted there during the 8th-10th (*antea*, p. 250), in which case one on the Kingsbridge estuary, Devon, during 14th-20th May was presumably a different bird. About this time, on 16th May, a Cream-coloured Courser (*Cursorius cursor*) was watched over a sandy area with gorse and coarse grass at Par Beach, Cornwall. Late Fieldfares (*Turdus pilaris*) were reported from Rochester, Kent, on the 20th, and Monks' House, Northumberland, on the 21st, and an immature Crane (*Grus grus*) was observed flying over the Dunwich-Walberswick Marshes, Suffolk, on the 21st and 25th. An unusually good passage of Spotted Flycatchers (*Muscicapa striata*) and movement of Yellow Wagtails (*Motacilla flava*) took place at Monks' House from the 20th for several days.

A late skein of 8 Pink-footed Geese (*Anser brachyrhynchus*) alighted at Fair Isle in cyclonic weather on 21st May, and next day a Short-eared Owl (*Asio flammeus*) and an influx of female Greenland Wheatears (*Oenanthe oe. leucorrhoea*) occurred. There were good falls of nocturnal migrants at Fair Isle and in Shetland between 23rd-26th May and again from the 29th-31st, but these have been so well documented that it seems best to defer them for fuller treatment later in this summary.

A pair of Quail (*Coturnix coturnix*) was seen and heard at Burnham Overy, Norfolk, on 25th May, and another was killed by striking overhead wires near Holt on the 31st. The peak of

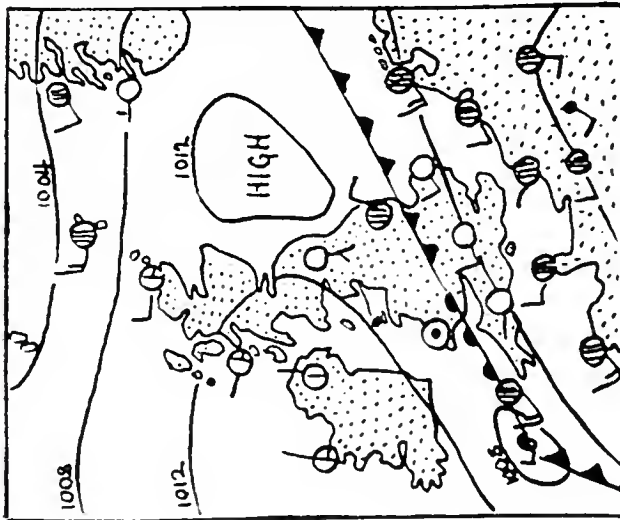

Fig. 1

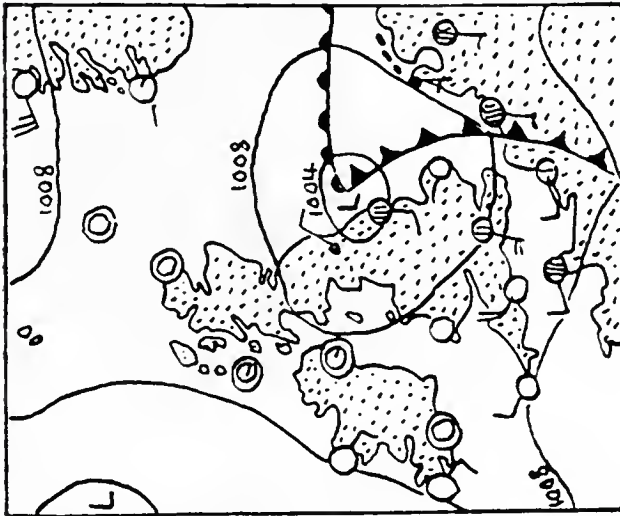

Fig. 2



Fig. 3

Figs. 1-3—Midnight weather-maps preceding early morning emigration of Jays (*Garrulus glandarius*) on the Dorset coast, 10th-12th May 1958. Despite the changing pressure-distribution, light westerly breezes and clear skies prevailed throughout the period of the migration in S. England (see pages 277-278). Figs. from "Daily Weather Report" of the Meteorological Office (Air Ministry), with acknowledgements to the Controller of H.M. Stationery Office.

Spotted Flycatcher passage through Bardsey, Caernarvonshire, fell between the 25th-28th, with the weather clearing quickly after a depression, and Garden Warblers (*Sylvia borin*) were also present. There was a Purple Heron (*Ardea purpurea*) at Walthamstow Reservoir, Essex, on the 25th; a Kite (*Milvus milvus*) was seen at Woodbastwick, Norfolk, on the 26th; and a Wood Sandpiper (*Tringa glareola*) which had been several days at St. Kilda, Outer Hebrides, was caught and ringed. From Ireland there are reports of a Lesser Yellowlegs (*Tringa flavipes*) at Lough Beg, Co. Derry, and a Solitary Sandpiper (*T. solitaria*) at Castlerock, Co. Derry, on the 24th and 25th respectively: wind-conditions for a trans-Atlantic crossing were favourable between the 18th-20th, but not later. If confirmed, the latter will be the first and the Yellowlegs the second Irish records of these species. There was also a Little Stint (*Calidris minuta*) in full summer plumage at Castlerock on 25th May, a very rare bird in Ireland in spring. The Little Gull (*Larus minutus*) is another species that is not frequently recorded in Ireland and so immature birds at Larne Lough, Co. Antrim, on 4th May and at Wexford harbour on the 10th are of interest. Incidentally, the previous weeks had been quite notable for Little Gulls in England and among the reports received were the following inland ones: 3 immatures at Staines, Middlesex, on 13th April; 2 birds at Cressage, Shropshire, on 17th April; and an adult in breeding plumage at Cannock, Staffordshire, on 21st April.

The reference to American waders in the last paragraph makes this an opportune moment to mention, out of chronological order, a June occurrence which is perhaps more likely to have made the actual crossing of the Atlantic during May. On 15th and 16th June a Wilson's Phalarope (*Phalaropus tricolor*) was observed on Malltraeth Lake, Anglesey: like the one in Bedfordshire a month earlier (*antea*, p. 251) this was a female in good summer plumage and it could indeed have been the same individual.

To return to the end of May, however, a Woodchat Shrike (*Lanius senator*) was reported from near Dursley, in Gloucestershire, on the 27th, and the 28th was a peak day of Hirundine and Swift (*Apus apus*) passage at Bardsey Bird Observatory, where 5 Sanderlings (*Crocethia alba*) were recorded on the 31st.

#### MIGRATION AT ST. KILDA

Apart from steady migration of Wheatears, there was a thin passage at St. Kilda at this time, with Spotted Flycatcher, Sedge Warbler (*Acrocephalus schoenobaenus*) and Willow Warbler (*Phylloscopus trochilus*) represented, and on the 27th several Hirundines included the islands' first record of a Sand Martin (*Riparia riparia*). A second turned up on the 30th, together with a Greenland Redpoll (*Carduelis flammea rostrata*), and there was an apparent increase in the number of Twites (*C. flavirostris*). A Merlin (*Falco columbarius*) and Garden Warbler (*Sylvia borin*)

were present at the beginning of June. Forty miles to the east, in central North Uist, a Long-tailed Skua (*Stercorarius longicaudus*) was seen on 21st May.

Few notes have come to hand from elsewhere for the end of the month. There is an undated report of a Roller (*Coracias garrulus*) found dead in Co. Kerry, and it will be recalled that a similar fate befell one at St. Agnes, Scilly Islands, in mid-May (*antea*, p. 252). There were late Hoopoes (*Upupa epops*) at Braintree, Essex, and in the Stour Valley, and single birds were seen at Bardsey, Caernarvonshire, on 30th April, 3rd and 29th May; on 3rd May there was also one at Great Saltee. (There was a noteworthy movement of this species in Devon from 22nd April, with at least 7 sightings before the end of the month, and a further record at Kingsbridge on 11th May.) A Pratincole (*Glareola pratincola*), with a chestnut under-wing, was seen by two independent parties at Hanningfield, Essex, on 31st May.

#### MIGRANTS IN EARLY JUNE

A male Woodchat Shrike was observed 400 yards from the sea near Seaton, Devon, on 1st June, on which day a Squacco Heron (*Ardeola ralloides*) appeared at Slapton Ley in the same county; the latter remained until the 9th. On the 7th another Little Egret was seen in Cornwall, this time on the River Camel. From 4th to 7th June there were highs north of the British Isles and over central Europe, and shallow low pressure centres over the eastern Atlantic, so that a generally easterly or S.E. airstream prevailed in the south, with periodic fog in Holland and along the east coast.

Also on the 7th 2 Sanderlings came inland to Hanningfield, a Quail was ringed at the lighthouse on Bardsey, and a Glaucous Gull (*Larus hyperboreus*)—which had wintered in the area—was still at Cley, Norfolk. A Black-winged Stilt (*Himantopus himantopus*)—"a lovely bird with a pink flush on the breast in certain lights"—came to Minsmere, Suffolk, on this day, and was still there on the 29th. A Spoonbill (*Platalea leucorodia*), thought to be the bird which had left a month before (*antea*, pp. 207, 250), returned to Hanningfield on the 14th, staying at least to 29th June, and there were 2 Spoonbills at Breydon, Norfolk, for almost the whole of June. Another two Woodchat Shrikes reached Great Saltee, Co. Wexford, on 3rd and 6th June, and one was reported at Buxton Heath, near Norwich, Norfolk, on the 15th.

#### COMMON SCOTER MOVEMENTS

On this same day, 15th June, three drake Common Scoters (*Melanitta nigra*) were reported from Blagdon Reservoir, Somerset, and during the month we have received additional observations of this species at inland waters between 6th-16th April (*antea*, p. 208). The most striking records concern the Queen Mary Reservoir, Middlesex, where 5 males and 4 females on 6th April

increased to 16 males and 6 females on the 10th, only 8 remaining by the 13th. Also worth noting is that on 19th April some 1,500 Scoters, followed by about 1,800 next day, were seen migrating eastwards off St. Catherine's Lighthouse, Isle of Wight. More recently and much more remarkable, at Swinsty Reservoir, near Otley, Yorkshire, there was on 28th June a gathering of some 250 Common Scoters of both sexes—perhaps the largest inland flock ever reported in England; they had gone by the next morning.

#### THE SECOND HALF OF JUNE

There was a very late female Fieldfare and a Black Redstart (*Phoenicurus ochruros*) on the Farne Islands, Northumberland, on 12th June, and the arrival of Grey Lag Geese (*Anser anser*) which moult on the islands every summer began with 7 birds on the 19th and had built up to 21 by the 23rd. An Arctic Skua (*Stercorarius parasiticus*) was chasing the terns between the Farnes and Budle Bay on the 21st. An Iceland Gull (*Larus glaucooides*) was still at Shoreham, Sussex, on 17th June (*antea*, pp. 207, 251), and perhaps it was the same bird which appeared at Southwick on the 13th and 18th of the month. Another was present throughout the first half of June at Baltasound in Unst, Shetland, and at St. Kilda the two previously-recorded birds (*antea*, pp. 207, 250) disappeared on 26th May and 3rd June. An immature Little Gull appeared at Hanningfield, Essex, on the 22nd and a Shag (*Phalacrocorax aristotelis*) "left over" from the early spring movement (*antea*, p. 208) was still present on that day; the Little Gull had not left by the 29th.

At about 17.00 hours on the 21st, following a period of heavy frontal rain, there was an immense movement of thousands of Swifts at Minsmere, Suffolk, and several observers had excellent views of an Alpine Swift (*Apus melba*) among these birds. At the same locality a week later, on 28th June, a Great Reed Warbler (*Acrocephalus arundinaceus*) was identified (see also below).

#### MIGRATION AT FAIR ISLE

To turn now to Fair Isle and Shetland, where the flow of spring migration is often noticeable until a much later date than in the south. Cyclonic developments in the North Sea between 23rd and 26th May were responsible for an interesting surge of passerine movement, beginning with a few Blackcaps (*Sylvia atricapilla*) and a fine male Red-spotted Bluethroat (*Cyanosylvia s. svecica*), apparently drifted through a col between a high over southern Sweden and an active low centred on St. George's Channel. The occluded front of this low spanned the North Sea during the night of the 24th, and on the two following days, with low pressure deepest over northern Scotland, the south-east wind-drift from the Continent was intensified. Sedge Warblers and *Sylvia* spp., especially Whitethroats (*S. communis*), were the dominant birds, with Spotted Flycatchers and Tree Pipits (*Anthus trivialis*), and a



last flush of Pied Flycatchers (*Muscicapa hypoleuca*) and Willow Warblers. A Bluethroat was trapped and 2 Dotterel (*Charadrius morinellus*) were seen on the 24th, and with the low filling in misty weather on the 26th a Wood Sandpiper, Cuckoo (*Cuculus canorus*) and Turtle Dove (*Streptopelia turtur*) appeared.

A brief slack period followed until on the 29th a further movement began, embracing much the same species, with Whitethroats as numerous as on 15th May (*antea*, p. 252) and Sedge Warblers at a spring peak of 25 birds. (At Bardsey the spring peaks for Whitethroat were on 1st and 5th May, and for Sedge Warbler on the 3rd and 5th). There were 7 Spotted Flycatchers and several Tree Pipits, a Black Redstart, the last Snow Bunting (*Plectrophenax nivalis*), and a Short-eared Owl. The last Bramblings (*Fringilla montifringilla*) were recorded on the 29th-30th and 2nd June, and the residue of the April invasion of Chaffinches (*F. coelebs*) lingered until 11th June. There were 2 Bluethroats on 31st May and Blackcaps on 1st and 3rd June. The wind at Fair Isle was very light during most of this period, and variable between north-east and south-east, and until the 31st (when a frontal situation developed) quiet col weather prevailed in Scotland and over the North Sea.

#### TREE SPARROWS AND SHRIKES

Tree Sparrows (*Passer montanus*) were concerned in both movements, and in fact this species has not occurred in such numbers at Fair Isle since the Bird Observatory began work ten years ago. It will be recalled that a party of 15 arrived on 14th May (*antea*, p. 252): 2 more appeared on the 25th, to be followed by an influx of 6 on the 29th and 3 on the 31st. Parties numbering 5 were seen on 3rd and 5th June, and laggards were noted on the 13th and 14th of the month. Some of these may have been Scottish birds moving in the col weather between 28th-30th May, since St. Kilda shared the movement, having no fewer than 25 Tree Sparrows on the 30th, followed by 8 on 1st June, 12 on the 3rd, and a final bird on the 5th.

During late May and the first week of June there was a noteworthy passage of Red-backed Shrikes (*Lanius cristatus collurio*), the biggest at Fair Isle since the spring of 1951 (see *Bull. F.I.B.O.*, no. 2, pp. 23-25). This time the movement was a full week later, the first being a female on 23rd May, and the last a bird on 10th June. Most of the records were concentrated between 29th May and 7th June, with a peak on the 4th when 2 males and 3 females were noted. (Peaks in 1951 were on 26th and 30th May, with a preponderance of males). A female Lesser Grey Shrike (*Lanius minor*) appeared on the 30th and was caught in a mist-net on 1st June.

#### OTHER SHETLAND OBSERVATIONS

A Great Reed Warbler was identified at Spiggie, Shetland,

on 4th and 5th June, and Blackcap, Garden and Sedge Warblers, and a few *acredula*-type Willow Warblers, were other birds present. This influx took place in pre-frontal misty weather, and brought to Fair Isle an old male Black Redstart, a Nightjar (*Caprimulgus europaeus*), an Icterine Warbler (*Hippolais icterina*), and a Long-eared Owl (*Asio otus*) which was trapped on 7th June. There had also been an Icterine at Spiggie on 3rd June. This movement was noticed by Dr. W. J. Eggeling as far north as Unst, where there were a number of *Sylvia* spp., and also a Green-shank (*Tringa nebularia*) and Quails. A House Sparrow (*Passer domesticus*) and male Snow Bunting were sharing Britain's most northerly rock, Muckle Flugga, on the 7th, and both Garden Warbler and Redwing (*Turdus musicus*) were singing at Halligarth on the 8th. Garden Warblers were still present on the 10-11th, and on the 13th a Lesser Whitethroat (*Sylvia curruca*), female Stonechat (*Saxicola torquata*) and Dark-breasted Barn Owl (*Tyto alba guttata*) were seen. A Black Redstart was noted on the island of Noss on the 22nd.

A Common Buzzard (*Buteo buteo*)—of extreme rarity in Shetland—which had arrived at Fair Isle on 31st May was still present on 20th June. The Fair Isle picture would hardly be complete without some really outstanding rarity, and (again reflecting 1951—see *Bull. F.I.B.O.*, nos. 2, p. 26, and 3, p. 3) pride of place must go to 2 Subalpine Warblers (*Sylvia cantillans*), a male being trapped on 12th June and a female next day. The whole of Britain was dominated by anticyclonic weather at this time, with cols in the North Sea and Western Approaches, so that the winds everywhere were light and southerly, with a slightly S.E. tendency along the east coast and in the northern isles. A Quail was present on Fair Isle on the 13th-14th.

#### CROSSBILL INVASION

As we go to press, we are receiving reports of Crossbills (*Loxia curvirostra*) from various parts of the country and it seems clear that yet another invasion—the third in the last six years (see *antea*, vol. xlix, pp. 289-297; vol. L, p. 496)—has occurred. Except for totals of about 200 on the island of Rhum, in the Inner Hebrides, on 20th June and again on the 30th (with the numbers in between these dates not exceeding 20), the groups reported have not been large. Fair Isle, for example, had up to 12 and no more on 27th June and the days following. But the movement has clearly been widespread because by 17th July Crossbills had been reported to us from 26 English counties. We hope that readers will send in all Crossbill records as quickly as possible.

**PURCHASED**

1 2 JUL 1958



## SMALL ADVERTISEMENTS

9/- for 3 lines (Minimum); 3/- for each extra line or part thereof. For the use of a Box Number there is an extra charge of 1/-.

9 x 40 Wrayvu Binocular £18/18/0, exchanges, repairs, lists. Bass & Bligh, 18, Market Arcade, Leeds 1.

WANTED—Copies of *British Birds*, MAY, JULY and AUGUST 1957. The Publishers will still pay full price and postage for any in good condition.

BACHELOR, 33, interested in nature study in general, ornithology in particular, desires post: field assistant, valet, interested in gardening, able to drive. 3 years' practical experience nursing, medical, surgical and first aid (R.A.M.C.). Willing to travel anywhere abroad. With present employer 18 years (toolmaker), reference. Interview welcome. Box JY8.

### SPEND YOUR HOLIDAYS IN A BIRD WATCHERS' PARADISE

#### PLACE MANOR

Nestling in the lush Sub-Tropical vegetation of St. Anthony-in-Roseland, on the edge of lovely Percuil Creek, with its own five safe sandy Bathing Beaches. This peaceful spot (the outside world has never known) is a haven of rest for countless numbers of our birds.

Open all the year round. Ideal for a Winter Holiday: THERE IS NO REAL WINTER IN ROSELAND.

Terms from £5 5s. per week, all round. Write for Illustrated Brochure to O. Harte, Place Manor, St. Anthony-in-Roseland, Portscatho, Truro. Phone Portscatho 256. Enclose medium-sized stamped addressed envelope.

ON THE GLORIOUS  
CORNISH COAST

AVOCET COUNTRY: chalet, twin beds, electric kitchenette; terms from Anderson, Broad St., Orford (Tel. 237).

BRITISH BIRDS, 1952-55 bound, 1956-57 unbound; as new. Offers to Box JY22.

BINOCULARS AND TELESCOPES. New and used. Descriptive lists and expert advice on request. Exchanges, overhauls. J. R. Hebditch, F.B.O.A., F.S.M.C., 44 Hallgate, Doncaster.

BINOCULARS AND TELESCOPES, new and reconditioned, at reasonable prices. Approval allowed, also part exchanges. Lists from Hatton Optical Co. Ltd., Lansdowne, Bournemouth, Hants. (Established 1930).

BINOCULARS AND TELESCOPES, repaired, cleaned and adjusted; send your instrument for estimate by return. Hatton Optical Co. Ltd., Lansdowne, Bournemouth, Hants.

FINEST VALUE YET

£10 19s. 6d.

#### PRISMATIC BINOCULARS

30 mm. objectives, coated for extra light transmission under poor lighting conditions.

Magnification  $\times 8$ . Field of view 140 yards at 1000 yards. Centre wheel focussing. Weight 17 oz.

*Complete with lanyard and  
purse-type case with sling*

IDEAL FOR BIRD WATCHING  
AND ALL SPORTS

SENT ON 7 DAYS' APPROVAL

**M. W. DUNSCOMBE, Ltd.**

(Dept. PT),

5-7, St. Augustine's Parade.

Bristol 1.

Phone 22155 (3 lines) Est. 1707

*Repairs and overhauls of  
Binoculars and Telescopes at  
reasonable prices.*

*Estimate if desired.*



*Leaflet B55/BT  
on request*

Types C.F.18 and C.F.24 (8 × 30.5 mm.) are highly favoured by bird-watchers, C.F. 24 having an extra wide field of view which is particularly valuable for observing birds in flight. With those who prefer a higher magnification, type C.F.43 (10 × 42 mm.) is a firm favourite.

# *Binoculars by* **BARR & STROUD Ltd.**

ANNIESLAND, GLASGOW, W.3 — London Office: 15 Victoria St., S.W.1

*Printed in Gl. Britain by WITHERBY & CO., LTD., WATFORD, HERTS.  
Published by H. F. & G. WITHERBY, LTD., 5, WARWICK COURT, W.C.1.*

# BRITISH BIRDS



AUGUST 1958

THREE SHILLINGS

# BRITISH BIRDS

AN ILLUSTRATED MONTHLY MAGAZINE

Edited by

E. M. NICHOLSON

W. B. ALEXANDER                      A. W. BOYD

I. J. FERGUSON-LEES

P. A. D. HOLLOM                      N. F. TICEHURST

*Editorial Address* : 30, St. Leonard's Avenue, Bedford.

*Photographic Editor* : G. K. YEATES

Annual Subscription £2 (including postage and despatch)

payable to H. F. & G. Witherby Ltd., 5, Warwick Court, London, W.C.1

---

CONTENTS OF VOLUME LI, NUMBER 8, AUGUST 1958

---

	PAGE
Notes on the breeding of the Iceland Gyr Falcon. By Philip Wayre and G. F. Jolly ... ..	285
Late season singing of the Yellowhammer. By Noble Rollin ... ..	290
Photographic studies of some less familiar birds. XCI—Bridled Tern. Photographs and text by John Warham (plates 45-48) ... ..	303
Notes:—	
Eider's method of eating crabs (N. Picozzi) ... ..	308
Attempted coition between House Martin and Sand Martin (P. E. D. Cooper) ... ..	308
Magpie's rapid replacement of dead mate (C. D. T. Minton) ... ..	309
Cock Blackbird feeding juvenile Song Thrush (Christopher M. Swaine)	309
Chiffchaff and Whitethroat taking insects from water (Dr. Jeffery G. Harrison) ... ..	309
Tree Pipits feeding nestling Skylarks and removing faecal sacs (R. P. Cockbain) ... ..	310
Abnormal growths on the legs and feet of Chaffinch and Blackbird (A. D. Townsend) ... ..	310
Green Singing Finch living "wild" in Hampshire (F. R. Clifton) ...	311
Reviews:—	
<i>The Birds of the British Isles</i> . By D. A. Bannerman. Illustrated by G. E. Lodge. Vols. VI and VII ... ..	311
<i>A Bird Watcher in Kenya</i> . By Vernon D. van Someren ... ..	313
Forestry Commission Leaflets: <i>The Crossbill</i> , by Bruce Campbell; <i>The Capercaillie</i> , by C. E. Palmar; <i>The Crested Tit</i> , by Bruce Campbell ... ..	314
Recent reports and news. By I. J. Ferguson-Lees and Kenneth Williamson ... ..	314

---

Cover photograph by G. K. Yeates: Corn Bunting (*Emberiza calandra*)



## BRITISH BIRDS

---

### NOTES ON THE BREEDING OF THE ICELAND GYR FALCON

By PHILIP WAYRE and G. F. JOLLY

DURING THE SUMMER of 1956 we visited the north-east of Iceland for the purpose of studying and filming the breeding of the Iceland Gyr Falcon (*Falco rusticolus islandus*). The expedition was in the Myvatn area from 9th to 21st June.

We wish to record our most grateful thanks to Dr. Finnur Gudmundsson, William F. Palsson and Sverir Trygvsson, without whose help and advice we should have achieved very little in the short time at our disposal.

#### *Eyries located.*

Seven eyries were found, of which four were definitely, and five probably, occupied in an area covering 440 sq. km. averaging 88 sq. km. per occupied eyrie. Nearest occupied eyries were 8 km. (5 miles) apart.

#### *Nest site.*

Six eyries were visited; all of them were found either in gorges with steep sides, or in comparatively low cliffs and were well sheltered by overhanging rock. This overhang is important, not only for protection in rough weather, but also to provide shade for the eyasses. It was most noticeable at the eyrie filmed that the eyasses soon began to pant and appear distressed when the sun shone on a calm day. They then invariably retreated into the shade of the overhang. At two eyries the eggs were laid in nests made of twigs, but it is impossible to be certain that they were not old nests of the Raven (*Corvus corax*).

#### *Breeding season.*

On 20th June one eyrie had two youngsters about four weeks old, another had four youngsters about six weeks old. Taking

twenty-eight days as the incubation period, eggs must have been laid during the first half of April, or about the same time as in Norway, as given by Hagen (1952). He states that the Norwegian Gyr Falcon (*F. r. rusticolus*) in the Dovre high fjell nests so early that it is forced to feed its young on adult Ptarmigan (*Lagopus mutus*) and Willow Grouse (*Lagopus lagopus*). He points out that, unlike the Gyr, the Peregrine (*F. peregrinus*), Merlin (*F. columbarius*) and Sparrowhawk (*Accipiter nisus*) nest later so that they are able to feed their offspring on the young of those birds which form their main food supply. He goes on to say that it is not easy to understand the significance of the Gyr's early breeding season. The Gyrs in Iceland that breed in the interior must be largely dependent on Ptarmigan. As in Norway, they breed so early that the eyasses are fed exclusively on adult Ptarmigan, ducks and other birds. This adaptation ensures that, when the young Gyrs first start hunting for themselves, there are young Ptarmigan and flapper ducks for them to begin on. They would almost certainly find an old Ptarmigan too fast for them. There is little vegetation at the time of the year when the eyass Gyrs are in the nest, and therefore Ptarmigan are conspicuous and this must be a considerable help to the parents in feeding the young.

*Behaviour of adult Gyrs when eyries were visited.*

At two eyries, both containing young, the adults mobbed hard whenever an intruder approached. Both parents would attack one after the other, screaming their harsh "kwek-kwek-kwek" cries. Although their attacks were not pressed home, the birds always passing several feet away, they were certainly impressive.

At a third eyrie both adults flew round once without calling while we were in the gorge, then disappeared and did not return. Upon examination, their nest was found to be empty.

*Method of hunting employed by adult Gyrs.*

During the whole time we were in daily contact with the Gyrs, we saw surprisingly little of the parents hunting. Evidently their normal method was not to "wait on" like Peregrines. The terrain, flat lava desert intersected by crevasses and gorges, is not suitable for this method of hunting, which in order to achieve surprise—the cardinal point in any attack by a raptor—requires mountainous country with valleys or steep cliffs.

As stated by Hagen (1952), the Gyr Falcon is a specialist in pursuing and catching Ptarmigan, and its method would seem to be to fly low and fast across country, following the contours closely, thus suddenly surprising and grabbing its quarry, often a cock Ptarmigan sitting on a slab of rock in the bottom of a gorge. This is also the usual method of hunting adopted by the Greenland Gyr Falcon (*F. r. candicans*) (Salomonsen, 1950). That the Gyr does not naturally "wait on" is borne out by the experiences of the authors (both of whom have handled and flown



trained Gyrs), though it is possible to train them to do so. Trained Gyrs also pursue quarry over far longer distances than Peregrines, and will start after and determinedly pursue a bird which has had a good start. Furthermore, if the country is open enough, the Gyr will often eventually fly into and kill its quarry long after any Peregrine would have given up. A Gyr that is flying to hunt is at once recognisable by its powerful, determined action and fast wing-beat. The greater agility of the Gyr on the ground (a most noticeable feature in trained Gyrs) enables it to catch quarry which has "put in" or been knocked down, with far greater facility than the Peregrine. This is also characteristic of both the Saker (*F. cherrug*) and the Lanner (*F. hiarmicus*), and supports the suggestion (Meinertzhagen, 1951) that the Gyr should be grouped with these falcons.

#### *Behaviour at the eyrie.*

A total of 40 hours was spent in a hide ten metres from an eyrie. The eyasses (two) were at this time about a month old. Upon six days (13th-19th June) the hide was occupied from 7.30 a.m. till 1.00 p.m. or later.

From the fragments of food on the ledge and the behaviour of the eyasses, it was on each occasion certain that they had been fed once in the early hours before 7.30 a.m.

On four of six days the falcon arrived at the ledge without food and inspected the eyasses, sometime between 8.30 and 11.30 a.m. She would stay about one and a half minutes and then leave. As soon as either parent came into view the eyasses would sit up and scream lustily whether the adult was carrying food or not. This screaming continued while the old bird was at the nest whether with food or without. Of six feeding visits watched from the hide, three were made by the tiercel and three by the falcon. The falcon, however, only actually fed the eyasses twice. The third time she arrived with the tiercel, each carrying a Ptarmigan, and left almost at once, leaving the tiercel to do the feeding.

In addition to this visit by the pair, one more visit by both old birds together was observed and filmed. This time, with much wing flapping and screaming, both arrived at the ledge together, though only the tiercel had any food. The falcon left almost at once and sat on her favourite crag while the tiercel fed the eyasses.

*The Handbook* (Witherby *et al.*, 1939) states that "the male provides all food for young and mate; latter remains at nest and breaks up prey and feeds young". This was not so at the nest under observation.

The tiercel was more gentle with the youngsters than the falcon was, and appeared to take far more trouble in tearing up the food and seeing that both the chicks got a fair helping, though the larger one got the lion's share and was always fed first whenever the nest was under observation. Both adults took away the remains of a carcass after feeding. Virtually the whole time the eyrie was under observation the falcon could be seen from the

hide. She would sit either on one of her two favourite look-out positions on the highest crags in the vicinity, or, when satisfied that nobody was in the area, she would spend her time on a shelf of rock opposite the nest. She was rarely out of sight for more than a few minutes, except on one occasion referred to above when she and the tiercel returned to the eyrie each carrying a Ptarmigan. Upon the other two occasions that she fed the eyasses, it seems probable that she took over the quarry from the tiercel. This could not be seen from the hide, but the few moments she was absent would hardly have sufficed for her to catch a Ptarmigan herself.

It would appear that the tiercel at this stage (young about a month old) does most of the hunting, and probably usually hands over his quarry to the falcon to do the actual feeding of the eyasses. The tiercel does, however, often feed them himself. That the falcon, while spending most of her time in the vicinity of the nest, does also sometimes hunt and bring food to the eyrie, was apparent when both parents arrived with quarry simultaneously. No brooding of the young was seen to take place.

The eyasses slept much of the time while the adults were away from the eyrie, and after a meal they were particularly sleepy and quiet. As the time wore on however, they became more energetic and wandered about the nest ledge. They would sit up, preen and pick their toes and indulge in periodic bouts of wing flapping. To do this, one of the eyasses would advance towards the edge and spread its wings (of great length even at this early age), it would then give a flap and tip over on to its beak. This ungainly procedure would be repeated for several minutes and then the youngster would settle down panting from the exertion. Occasionally one of the eyasses would get up, stagger forward, turn round and carefully mute over the edge; hence the tell-tale white stain below occupied eyries.

*Number of feeds per day.*

From our observations it seems probable that the young were fed three times per day, i.e., before 7.00 a.m., between 11.00 a.m. and 1.00 p.m. and after 5.00 p.m. On an average, a feeding visit with a Ptarmigan lasted about 16 minutes. The smaller eyass was once seen to tear at the quarry himself while the adult was feeding the larger youngster.

*Kills brought to the eyrie.*

At the eyrie under observation, six kills were seen to be brought to the eyasses and all were Ptarmigan. The three brought by the falcon were all cock Ptarmigan, headless but unplucked and otherwise intact. The tiercel, however, brought part of a Ptarmigan (leg and thigh) on one visit, a well-plucked and headless Ptarmigan on another occasion, and on the third a headless cock Ptarmigan which had also been eviscerated.

Apart from a few feathers and morsels of food, no remains were

seen on the ledge at this eyrie. The litter of old Ptarmigan wings, etc., below the ledge was therefore possibly the remains of kills brought by the tiercel to the falcon while the latter was incubating.

On the ledge of another eyrie, there were the remains of a drake Scaup (*Aythya marila*), a Redwing (*Turdus musicus*) and the usual Ptarmigan wings and feet. The eyasses in this eyrie were, however, about two weeks older than those in the eyrie filmed.

#### *Method of treating kill.*

Many kills of cock Ptarmigan were examined, remains of hen Ptarmigan were rare, and it may be that early in the season the males of this species being whiter are more conspicuous after the snows have melted. Some carcasses had been plucked completely; in most cases, however, the wings had been broken off at the carpal joint and left lying with the primaries intact. In this respect, the behaviour of the Iceland Gyr Falcon would appear to differ from that of the Norwegian (Hagen, 1952). We frequently saw remains of kills in which the tibiotarsus of adult Ptarmigan had been snapped, or triangular pieces had been cut out of the sternum. Evidently the beak of the Iceland Gyr is no less strong than that of the Norwegian, as noted by Dementiev and Gortchakovskaya (1945).

#### *Colour variation of Iceland Gyr Falcons.*

At one eyrie the falcon was a lightish bird, her back being a beautiful silver grey with darker markings. She appeared to be about half way through the moult of her main plumage. The tiercel was very dark. At another eyrie, the falcon was dark, but the tiercel was very pale grey, at times appearing almost white. Both adults at a third eyrie were typical grey birds. There is considerable colour variation in Icelandic Gyrs, though it is unlikely that age has anything to do with it, as has been suggested (Hachisuka, 1927). Really white birds are probably very scarce and are more likely to be wanderers from Greenland, especially during the winter when birds from the north-east of Greenland migrate southwards and regularly visit Iceland. The Icelandic Gyr would seem to correspond with the grey low-arctic *holboelli* type of the Greenland bird, described by Salomonsen (1950), though in Iceland there are considerable variations within this phase.

#### *Breeding cycle of the Gyr in north-east Iceland.*

Several farmers in the area said that the numbers of Ptarmigan fluctuated considerably, reaching a peak every three or four years. They also stated that when Ptarmigan were plentiful (as in 1956) more cyries were occupied. As previously stated, the majority of Gyrs breeding in the *interior*, except for those nesting near duck or goose colonies, must be largely dependent on Ptarmigan, since other quarry is very scarce. Coastal eyries would not of course be affected, since sea birds would form the chief food supply

and their numbers remain fairly constant (Dementiev and Gortchakovskaya, 1945).

## SUMMARY

1. Observations on the breeding ecology of the Iceland Gyr Falcon (*Falco rusticolus islandus*) in N.E. Iceland during the summer of 1956 are discussed.

2. Eyries found are described—seven in all, of which four were definitely, and five probably, occupied.

3. Some suggestions are made concerning the early breeding season of the Gyr in relation to the breeding season of Ptarmigan and ducks.

4. Comments are made on the method of hunting employed by adult Gyrs, including the experience of the authors in handling and flying trained Gyrs.

5. A total of 40 hours was spent observing and filming at one eyrie. Observations made during this time are described.

6. Kills brought to the eyrie are listed, together with observations on the method of treating kills.

7. Colour variations in the Iceland Gyr Falcon are discussed.

## REFERENCES

- DEMENTIEV, G. P. and GORTCHAKOVSKAYA, N. N. (1945): "On the biology of the Norwegian Gyr Falcon". *Ibis*, 87: 559-565.
- FERGUSON-LEES, I. J. (1956): "Photographic studies of some less familiar birds. LXXII—Gyr Falcon". *Brit. Birds*, xlix: 310-312.
- HACHISUKA, M. U. (1927): *A Handbook of the Birds of Iceland*. London.
- HAGEN, Y. (1952): *The Gyr Falcon Falco r. rusticolus L. in Dovre, Norway*. Oslo.
- MEINERTZHAGEN, R. (1951): "Some relationships between African, Oriental and Palaearctic genera and species, with a review of the genus *Monticola*". *Ibis*, 93: 443-459.
- SALOMONSEN, F. (1950): *The Birds of Greenland*. Copenhagen.
- SVÄRDSON, GUNNAR (1957): "The 'Invasion' type of bird migration". *Brit. Birds*, L: 314-343.
- VESEY, E. (1936): *In search of the Gyr Falcon*. London.
- WITHERBY, H. F. *et al.* (1939): *The Handbook of British Birds*. London.

## LATE SEASON SINGING OF THE YELLOWHAMMER

By NOBLE ROLLIN

ALL-DAY WATCHES on the Yellowhammer (*Emberiza citrinella*) in August showed that the birds were giving relatively large song totals. The maximum recorded from one bird was 3,482 songs in one day. Apart from August being a month when very few other species in Britain sing persistently, this can be regarded as very strong singing for birds near the end of their breeding season. In previous all-day watches in April, May, July and August, Yellowhammers had given rather low song totals; and in observations at higher latitudes in Norway, from the latter part of June onwards, birds sang less than those in Britain and gave no high song totals at the end of the season.

### Part I—In Britain

The late season singing of the Yellowhammer has been recorded for a long time. Gilbert White (1813), writing in 1769, gave its song season from "Early in February, and on through July to August the 21st". Speaking of birds which sing on after mid-summer he said (in a letter dated 1770) that it "persists with more steadiness than any other". More recently Alexander (1938) has charted regular song continuing for about the first three weeks of August, irregular but fairly frequent song in the last week in August and first week in September.

The all-day watches on Yellowhammers made before the strong August singing mentioned above were as follows. Three all-day watches carried out on an individual bird at Wallsend (latitude  $55^{\circ}00'N.$ ), Northumberland, in 1942 gave 88 songs for the whole day on 12th April (Ref. No. 139), 485 songs on 17th May (Ref. No. 140) and 156 songs on 5th July (Ref. No. 141). This bird was not subject to much song competition. In general observations made right through the season it was never heard to sing very much and it is thought that these totals represent a fair sample of its daily total of song. An all-day watch made at Glanton (latitude  $55^{\circ}25'N.$ ), Northumberland, on 2nd August 1947 gave 277 songs (Ref. No. 142). On this occasion the amount of competition was not recorded. On 7th, 8th and 9th July 1945, in observations in connection with the effect of a partial eclipse of the sun, the normal output of song of four Yellowhammers singing in Crawley Dene, near Glanton, was ascertained. These birds were singing in competition with each other and in a day beginning at 02.37 hours\* and finishing at 20.32 they averaged 820 songs per bird. In all these observations none of the birds was selected because of any particular capacity, strong or weak, for song. The weather during these observations was as follows:— 12th April was mild, sunny in the morning and evening and overcast in the afternoon. 17th May and 5th July were both bright sunny days, the latter being the warmer of the two. There was not much wind during any of these three days. August 2nd was warm with hot sunshine in the early afternoon. There was a moderately strong but warm wind in the afternoon. During the 7th, 8th and 9th July observations the weather was warm, with varying amounts of hot sunshine. There was a warm wind during part of the observation period. These watches were made by the author.

#### AUGUST ALL-DAY SONG TOTALS

In August 1955, all-day watches were made on birds which were found to be singing strongly along the River Breamish, near Glanton, between the hamlets of Ingram and Hedgeley. On

---

\*All the times given are in Local Apparent Time, i.e. time by the sun at the place of observation. To convert to G.M.T. add 13 minutes to the July times and 14 minutes to the August times.

1st August 1955, the strongest singer of some five singing birds holding territories on the lower reaches of the river was observed all day. It gave a total of 2,279 songs (Ref. No. 143). All the other four birds sang at dawn, two giving very little song. The other two also sang a limited amount during the day. The strongest singer therefore sang altogether more than the others. The day was very hot with continuous bright or veiled sunshine up to Hour 18. Maximum temperature 82°F., minimum 47°F. There was a Force 2 breeze in most hours from Hour 7, which rose to Force 3 in Hour 17. Some rain fell during 18.45-19.00 hours.

On 5th August 1955, the two strongest singers of five singing birds holding territories a little over three quarters of a mile further up the river were observed all day. These two, designated No. 1 and No. 2, gave song totals of 3,482 songs (Ref. No. 144) and 2,686 songs (Ref. No. 145) respectively. The other three birds all sang varying amounts of dawn and daytime song. All sang less than No. 1 and No. 2, but between them sang considerably more than the four birds mentioned in the 1st August observations. In other words, singers No. 1 and No. 2 had much more song competition. On this day there was bright hot sun in the morning, with cloudless sky up to Hour 10. The afternoon was warm but mostly overclouded, with a hint of rain in Hour 17. Maximum temperature 72°F., minimum 42°F. From mostly calm up to Hour 9, the wind rose through Force 2 and 3 to Force 4 and 5 in Hours 14 to 19.

TABLE I.—NUMBER OF SONGS GIVEN EACH HOUR BY THREE YELLOWHAMMERS (*Emberiza citrinella*) IN AUGUST (BRITAIN)

Hour	3	4	5	6	7	8	9	10	11	12	13	14	15	16	17	18	19	20
Aug. 1st	337	250	198	34	139	179	37	153	89	188	52	24	106	66	177	164	74	12
Aug. 5th (1)	150	300	260	233	180	241	144	263	154	211	122	221	152	235	230	220	166	0
Aug. 5th (2)	114	103	256	236	227	245	72	208	172	160	85	165	102	107	146	205	51	32

The hour by hour results of these August watches will be found in Fig. 1, and the totals in Table I. It will be seen from Fig. 1 that the 1st August bird began with a high total in the first full hour and then continued on right through the day, but with much lower hourly totals. No. 1 of the 5th August birds began with rather a lower peak but continued through the day at a generally higher rate than the 1st August bird. The difference may be accounted for by the 1st August bird having less competition, except in dawn, and as will be seen later, by being nearer the end of its song season. No. 2 which had the second largest output of

song of its group did not achieve its largest hourly total until Hour 5. The 1st August bird began singing at 02.53 and ceased at 19.45. It sang 450 songs in its first full hour (02.53 to 03.53), and 86 songs in its last full hour (18.45 to 19.45). No. 1 started at 03.08 on 5th and ceased at 19.27, singing 333 songs in its first full hour and 175 songs in its last full hour. The

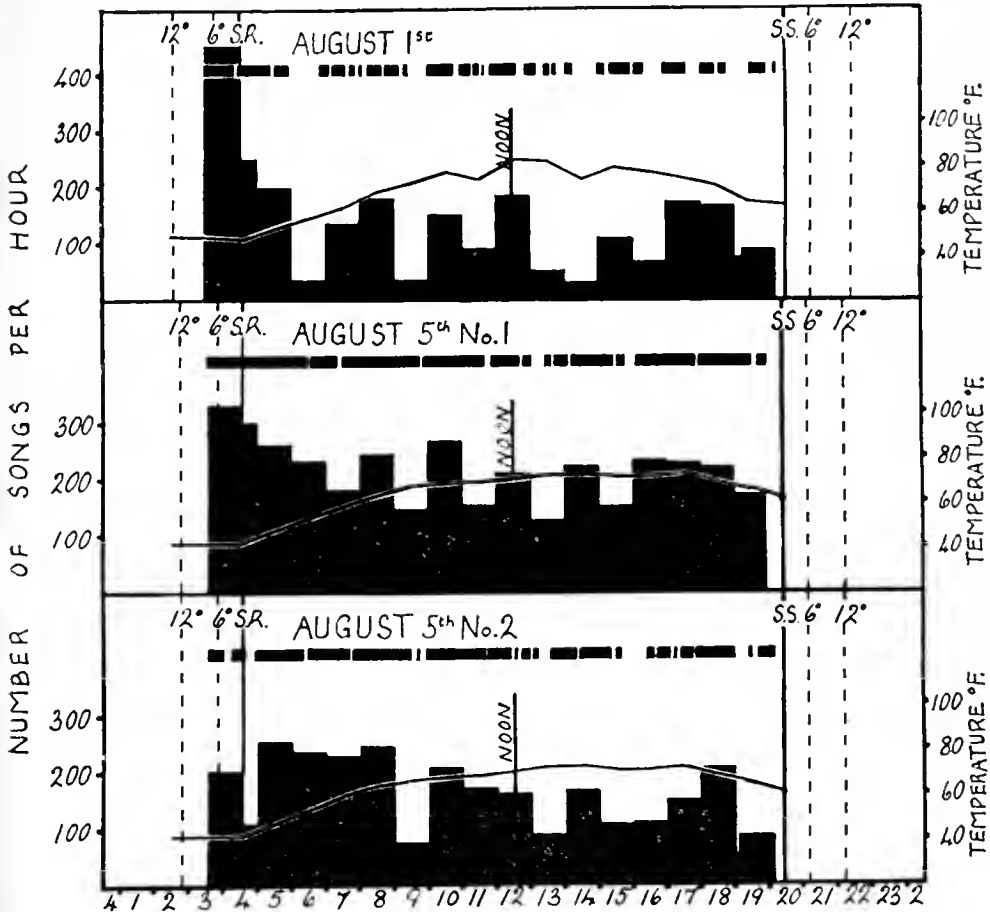

FIG. 1.—NUMBERS OF SONGS GIVEN DURING THE DAY BY THREE YELLOWHAMMERS (*Emberiza citrinella*) IN NORTHUMBERLAND: AUGUST 1955

The numbers of songs per hour are indicated by the black histograms, with the scales on the left. The thick broken line above the hourly totals in each case marks the number of clock five minutes in which the bird sang, the gaps representing similar periods when there was no song for five or more clock minutes; note that in all three birds song was relatively evenly distributed throughout the day. The thin line across each histogram shows the temperature (°F), with the scales on the right. The positions of sunrise (S.R.) and sunset (S.S.) are marked, and also the times when the sun was 6° and 12° below the horizon.

corresponding figures for No. 2 were 03.07 and 19.38, with 199 songs in the first full hour and 83 songs in the last. These first and last full hours are included in Fig. 1. Also included, and shown as a broken line above the hour by hour totals, is every clock five minutes (e.g. 03.35-03.40, 03.40-03.45) in which the bird sang. Periods in which there was no song for five or more clock

minutes are indicated by gaps. It will be seen that the song was relatively evenly distributed through the day. In Table I the song totals are given strictly hour by hour (from the half hour to the half hour, e.g. Hour 7 includes all songs given between 06.30 and 07.30). The observers who took part in these August all-day watches were D. H. Cowell, B. Craddock, H. Grey, R. L. Hunter, K. M. Hunter, A. King, J. Munro, K. Pescod and the author.

This singing was not exceptional. Other Yellowhammers in the district were heard singing vigorously. In a dawn and early morning study on 9th August 1955, west of the village of Glanton ( $1\frac{3}{4}$  miles from the Breamish birds), the number of minutes during which three Yellowhammers were heard singing was noted. Unlike the selected Breamish birds, the West Glanton Yellowhammers were not selected because of any particular capacity for strong (or otherwise) song. The figures obtained were approximate but were surprisingly similar to the strongest Breamish singers. The strongest West Glanton singer was heard singing during 165 minutes in the first three hours of song. No. 1 bird on the Breamish also sang during 165 minutes in the same period. The comparative figures for the second strongest singers were: West Glanton, 117 minutes; Breamish, 114 minutes. During observation the temperature rose from 44°F. to 51°F. Except for a quarter of an hour of sunshine the sky was generally overcast and there was about half an hour of very light rain.

#### TIME OCCUPIED IN SINGING

The No. 1 Breamish bird was heard during a total of 757 minutes. Some minutes were not wholly occupied primarily with singing, particularly when song ceased early in one minute and recommenced late in another. With songless half-minutes deleted, No. 1 occupied 12 hours 11 minutes in singing during the day. These figures can be compared with an unmated Song Thrush (*Turdus philomelos*) which occupied 9 hours 55 minutes in singing during an April day (Rollin, 1945).

#### END OF SEASON

Although the Breamish and Glanton birds were singing so strongly they were nevertheless near the end of their song season. On 14th August none of the down-stream Breamish birds were heard singing, although the strong singing male was in his territory. Upstream Nos. 1 and 2 were still singing freely, another less so but the other two were not heard at all. By the 16th only No. 2 sang freely and song was noticeably dying out towards the end of the third week in August. On 28th August three weak songs were heard on another part of the Breamish and two birds were singing moderately strongly north-west of Glanton. This was the last song heard.

#### DAWN PENETRATION

Fig. 2 shows the times of commencement of Yellowhammer



song at different points in the singing season. This series of times was collected between 1927 and 1955 inclusive in the area round Glanton. It was on birds unselected for any particular capacity for song (except for the records on 1st and 5th August 1955). The figure also shows the position of sunrise and the times when the sun was respectively  $6^\circ$ ,  $12^\circ$  and  $18^\circ$  below the horizon. In late February and early March there are two records where the birds did not begin to sing until after sunrise. After this, up to mid-April, there is a tendency to begin at about sunrise. From mid-April the birds start earlier and on 23rd there is a record of one beginning when the sun was  $6^\circ$  below the horizon. This moderately early phase continues until the end of May when the records show the first really early singing. This very early singing continues to the end of the season. This seasonal song pattern is quite different from most birds which begin song early in the year. Thus seven typical spring singers—Skylark (*Alauda arvensis*), Song

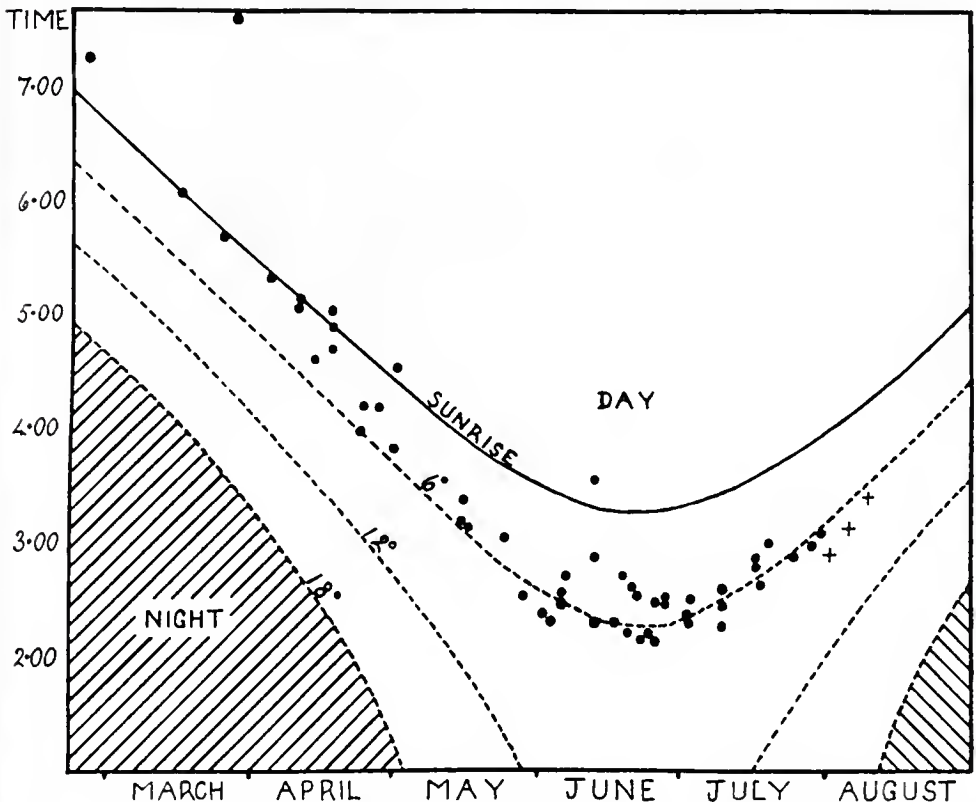

FIG. 2—TIMES OF COMMENCEMENT OF YELLOWHAMMER (*Emberiza citrinella*) SONG AT DIFFERENT POINTS IN THE SEASON: NORTHUMBERLAND, 1927-1955

The times are shown in relation to sunrise and to the positions of the sun  $6^\circ$ ,  $12^\circ$  and  $18^\circ$  below the horizon. Up to mid-April there is a tendency to begin about sunrise (or occasionally even later), but from the end of May to the end of July song begins regularly when the sun is more than  $6^\circ$  below the horizon and almost always well before sunrise. The times are not based on birds selected for any particular capacity for song, except in the cases of those on 1st and 5th August, marked here by the first two plus signs which represent the commencement times of the birds in Fig. 1 (the final plus sign represents the commencement time of unselected singers on 9th August 1955).

Thrush, Blackbird (*Turdus merula*), Robin (*Erithacus rubecula*), Dunnock (*Prunella modularis*), Wren, (*Troglodytes troglodytes*) and Chaffinch (*Fringilla coelebs*)—all showed relatively deep dawn penetrations in March, and all except the Chaffinch, which is normally a late singer, reached, and sang earlier than, the 6° line in March (Rollin, 1951). This deeper penetration of dawn is called by Nice (1943) the established period. It is surprising to find that the established period is not fully developed in the Yellowhammer until June and July. The Yellowhammer behaviour may in this connection be contrasted with the behaviour of the Song Thrush, which is thoroughly established and singing at low light intensities in March. From mid-May onwards Song Thrushes wait for successively more and more light before beginning to sing at dawn (Rollin, 1945). Whilst this is taking place in the Song Thrushes, the Yellowhammers are behaving in the opposite way and in June and July are starting to sing at a lower light intensity than they have done earlier in the year.

In this series of dawn records collected before August 1955, the deepest dawn penetration was 7°00' at the beginning of June and 7°00' in the second week in July (i.e. the Yellowhammers began to sing when the sun was 7°00' below the horizon). Details about dawn penetrations will be found in Rollin (1945 and 1951). On 1st August 1955, the birds began to sing at a dawn penetration of 8°00', on 5th at 7°30' and on 9th at 6°50'. On 1st and 5th August, therefore, the birds had a deeper dawn penetration than in any of the previous observations.

#### DISCUSSION

The high outputs for August 1955 were correlated with deep dawn penetration and there is no doubt that the birds were singing very well indeed. Conditions were favourable for a species which sings "during the sultriest hours" (Hudson, 1926), for the summer of 1955 was exceptionally hot and sunny with a drought which continued into the autumn. The *Monthly Weather Report* (1955) states that July was an "outstandingly sunny month" and the temperature in August was 3.5°F. above the average.

Parkhurst and Laek (1946) have shown that fresh eggs of the Yellowhammer may be moderately plentiful at the end of July and beginning of August, but there was little evidence of such breeding in the areas studied. The only breeding behaviour observed, except for the song, was (a) down-stream (where there were 5 territories), one fledged brood being fed; and (b) up-stream (5 territories), coition attempted once when a hen bird flew into one of No. 2 bird's singing trees. There was no feeding of any other young, in or out of the nest, no nest building, no evidence of incubation or, later in the month, any feeding of young which might have suggested incubation. Apart from the instances (a) and (b), hens were virtually absent from the scene and the males were singing without any complicating male-female behaviour.

It is possible, therefore, that the males were singing a form of end-of-season unmated song due to the absence or passive behaviour of the hens. Birds are known to have a large output of song when unmated—e.g. Montagu (1802), Nice (1943), and Rollin (1945). Singing at the end of the season without breeding takes place in other species. Perry (1946) mentions cock Corn Buntings (*E. calandra*) singing against each other throughout July without any breeding taking place. In Bicknell's Thrush (*Hylocichla minima bicknelli*) Wallace (1949) found that song was normally renewed at the end of the breeding cycle without breeding taking place. The present author noticed similar recrudescence of singing in the American Robin (*Turdus migratorius*) at Churchill, Manitoba, at the end of the season, after broods had left the nest (Rollin, 1951).

### Part II—In Higher Latitudes

The author was between latitudes  $63^{\circ}23'N.$  and  $69^{\circ}23'N.$  in Norway from 23rd June to 15th August 1956. At no time during this period were the Yellowhammers heard singing with the persistence which is normal for many Yellowhammers in Britain. More detailed observation showed very meagre outputs of song from these birds in higher latitudes. Like those in Britain the observations fall into two groups: (a) where the place of observation was *selected* because one or more birds had been heard singing well there; and (b) where the place of observation was not selected ("unselected") in any way in regard to Yellowhammers or their songs.

On 27th-28th June 1956, an all-day watch (Ref. No. 152) was made on an unselected Yellowhammer on Tautra Island (latitude  $63^{\circ}35'N.$ ) in Trondheim Fjord. This bird sang only 61 songs during the 24 hours. The songs were short and of very poor quality. It had nearly fully fledged young and had song competition from one other bird. On 1st July 1956, an all-day watch (Ref. No. 153) was made on an unselected bird near Okstad (latitude  $63^{\circ}23'N.$ ), south of Trondheim. It sang 185 songs in 24 hours and had song competition from one other bird which sang less. On 9th July 1956, an all-day watch (Ref. No. 154) was made on a selected bird near Skibotn (latitude  $69^{\circ}23'N.$ ), in Lyngen Fjord. It sang 488 songs in 24 hours. This bird was chosen as a strong singer and had song competition from about four other birds. Another all-day watch (Ref. No. 155) was made on the strongest singing bird in the same area (near Skibotn) on 27th July 1956, when song was waning. It sang 37 songs in 24 hours and had song competition from one other bird which sang less. This last watch does not fall into the category of selected or unselected, and has not been used in the comparisons given below. These totals all show low outputs of song. The song totals of unselected Norwegian birds, 61 and 185, may be compared with the song totals of unselected birds in Britain (latitude *ca.*  $55^{\circ}$ ).

which were 88, 485, 156, 377 and 820. The selected Norwegian singer, 488 songs, may be compared with selected birds in Britain which gave 2,279, 3,482 and 2,686 songs.

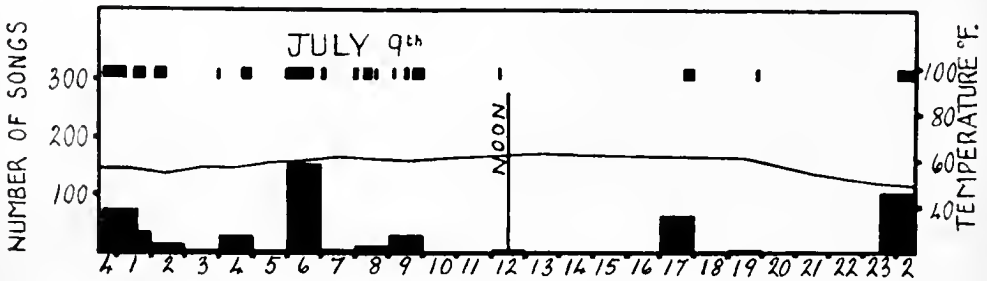

FIG. 3—NUMBER OF SONGS GIVEN DURING THE DAY BY A YELLOWHAMMER (*Emberiza citrinella*) IN ARCTIC NORWAY: JULY 1956

As in Fig. 1, the histogram indicates the hourly song totals with the scale on the left, the thick broken line and the wide gaps in it show the periods of clock five minutes in which the bird sang or did not sing, and the thin line represents the temperature with the scale on the right. Compare with Fig. 1 and note here the midnight song (in the continuous daylight of the north), the small hourly totals and the uneven distribution of the song during the day.

The result of the all-day watch on 9th July (at latitude  $69^{\circ}23'N.$ , under conditions of continuous daylight) is shown in Fig. 3. Observation was begun at 22.45\* on 8th July. The bird began to sing at 23.32, continued up to 23.52 and started again at 00.04. On the evening of the 9th it finished a series of 62 songs at 17.27, sang one song at 19.22 and then began its midnight song at 23.31, one minute earlier than on the previous evening. It continued over midnight without a break and was still heard singing at 00.45 (10th July). Apart from the midnight singing the two main peaks in this bird's song were in Hours 6 and 17. In the all-day watch on 27th July, at the end of the song season, when the sun was dipping below the horizon at midnight for a period of  $1\frac{1}{2}$ -2 hours, there was no midnight song. The bird gave some morning songs in Hours 4 and 5, but its main morning song was in Hour 8. Its only afternoon singing was in Hour 20. Neither was there any midnight song from the two unselected singers in the Trondheim area (latitudes  $63^{\circ}23'N.$  and  $63^{\circ}35'N.$ ), where, although the sun never dropped low behind the horizon, the twilight lasted about three and a half hours. The bird in the all-day watch on 27th-28th June gave some songs in Hour 3, but its main morning singing was in Hours 6 to 10 and main afternoon singing in Hour 17. In the all-day watch on 1st July the bird gave its morning song in Hours 5, 6, 7 and 9 and afternoon song in Hour 23. From this it will be seen that, apart from midnight song (given by the selected bird under conditions of continuous daylight)

\*All these times are in Local Apparent Time. To convert to Norwegian Standard Time add 20 and 22 minutes respectively to the 27th-28th June and 1st July times, and subtract 16 and 15 minutes respectively from the 9th July and 27th July times.

and lesser morning singing, the Yellowhammers had their *main* morning singing between Hours 5 and 10 inclusive, and afternoon song in Hours 17, 20 and 23. In the four all-day watches only seven songs (total) were heard in Hours 11 to 15 inclusive.

Details of the all-day watches in Norway are as follows:—

27th-28th June, latitude  $63^{\circ}35'$ , Tautra Island. First full hour 02.44-03.44, 6 songs. Last full hour 15.56-16.56, 7 songs. The songs in successive clock hours, which include all the songs given, were (beginning with Hour 3) 6, 0, 0, 6, 4, 9, 16, 9, 0, 0 (Noon), 4, 0, 0, 0, 7 (Hour 17). The day was mild but with a Force 4 breeze and overcast throughout. Light rain fell between 00.01 and 05.30, and between 20.00 and 24.00. Maximum temperature  $54^{\circ}\text{F}$ .; minimum  $46^{\circ}\text{F}$ . Maximum relative humidity 87%; minimum 68%. The watch was made by T. Gleghorn, H. W. Wright and the author who would like to thank Mr. S. Haftorn for arranging our visit to Tautra Island.

1st July, latitude  $63^{\circ}23'$ , near Okstad. First full hour 05.25-06.25, 89 songs. Last full hour 22.27-23.27, 24 songs. The songs in successive clock hours were (beginning with Hour 5) 29, 60, 37, 0, 35, 0, 0, 0 (Noon), 0, 0, 0, 0, 0, 0, 0, 0, 24 (Hour 23).

This was a day of much brilliant sunshine and clear sky with never more than a light breeze. Maximum temperature  $63^{\circ}\text{F}$ .; minimum  $42^{\circ}\text{F}$ . Maximum relative humidity 93%; minimum 47%. The watch was made by M. Carr, T. Gleghorn, E. Hewitson and the author.

9th July, latitude  $69^{\circ}23'$ , near Skibotn. First full hour 00.04-01.04, 73 songs. "Last full hour 23.00-24.00", 103 songs (song continued on after midnight). Songs in successive clock hours were, from 00.01 to 00.30, 38 songs, then (beginning with Hour 1) 37, 15, 2, 28, 1, 157, 3, 9, 29, 0, 0, 3 (Noon), 0, 0, 0, 0, 62, 0, 1, 0, 0, 0, 0 (Hour 23), then 23.30 to 24.00, 103 songs. The day began with cloud, but after weak sunshine in Hours 6 and 7 there was bright and mostly hot sunshine until the sun went behind a local ridge at 20.46. After this the sun continued to shine on the upper part of the fjord during the "night". The first six and the last four hours of the day were calm, but during the rest of the day there was a breeze of Force 3 or 4, which from noon to Hour 17 reached Force 5. The sky was cloudless from noon to midnight. Maximum temperature  $64^{\circ}\text{F}$ .; minimum  $49^{\circ}\text{F}$ . Maximum relative humidity 100%; minimum 65%. This watch was made by the author.

27th July, latitude  $69^{\circ}23'$ , near Skibotn. First full hour 4.29-5.29, 12 songs. Last full hour 19.07-20.07, 2 songs. In clock hours the only songs given were 5 in Hour 4; 7 in Hour 5; 23 in Hour 8; 2 in Hour 20. The day was mild and mostly overcast. It never had more than a light breeze and much of it was calm. Maximum temperature  $61^{\circ}\text{F}$ .; minimum  $49^{\circ}\text{F}$ . Maximum relative humidity 86%; minimum 65%. This watch was made by the author.

## SONG IN FIRST THREE HOURS

The number of minutes in which birds sang during the first three hours from the time of beginning song in the morning, was recorded at various latitudes in Norway. The results are shown in Table II. Data from the all-day watches on 27th-28th June, 1st July and 9th July are included.

TABLE II—NUMBER OF MINUTES IN WHICH YELLOWHAMMERS (*Emberiza citrinella*) SANG DURING THE FIRST THREE HOURS AFTER BEGINNING SONG (NORWAY)

<i>Selected Singers</i>			
June 24th	Latitude 63°23'N.	Near Okstad	40 mins.*
July 9th	„ 69°23'N.	Near Skibotn	33 mins.
<i>Unselected Singers</i>			
June 28th	Latitude 63°35'N.	Tautra Island	ca. 7 mins.
July 1st	„ 63°23'N.	Near Okstad	27 mins.
July 5th	„ 66°19'N.	Mo i Rana	25 mins.*
July 23rd	„ 69°23'N.	Near Skibotn	17 mins.*

\*In these three records, observation from the first song was not continued to the full three hours after song commenced and the figures are calculated from the following periods of observation from the first song: 24th June, 144 minutes; 5th July, 99 minutes; 23rd July, 98 minutes.

Comparative data compiled from the records of the watches mentioned in Part I on birds observed in Britain give the following:

*Minutes in which the bird sang during the first three hours from commencement of song, latitude 55°00'N.-55°25'N.: (selected singers), 1st August, 116 minutes; 5th August, No. 1, 165 minutes, No. 2, 114 minutes; (unselected singers), 5th July, 30 minutes; 7th-8th-9th July, 52 minutes; 2nd August, 29 minutes; 9th August, 1st bird, 165 minutes, 2nd bird, 117 minutes.*

These figures show that both selected and unselected singers recorded in Britain sang more in the first three hours of song than did the birds in higher latitudes in Norway. The averages are:

	<i>Selected Singers</i>	<i>Unselected Singers</i>
Latitudes 63°23'N.-69°23'N. (in Norway) ...	36 minutes	19 minutes
Latitudes 55°00'N.-55°25'N. (in Britain) ...	132 minutes	79 minutes

Details of the weather and competition have already been given for all the above except the 24th June, 5th July and 23rd July records in Norway. 24th June was overcast from midnight, with fine rain from 02.30; temperature range 45°F. to 47°F.; relative humidity 81% to 99%; wind Force 0-2; the bird had no song competition. On 5th July there was one- to three-tenths cloud; temperature range 56°F. to 60°F.; relative humidity 65% to 86%; wind Force 0; the bird had no song competition. On 23rd July there was eight-tenths or more cloud; temperature range 44°F. to 48°F.; relative humidity 66% to 99%; wind Force 0; the bird had competition from one other bird which sang less.

## END OF SEASON

The author was in the vicinity of Skibotn (latitude 69°23'N.), in Lyngen Fjord, Norway from 6th July to 13th August, and was

able to note the decline of song of Yellowhammers in the Arctic. There was no recrudescence of song at the end of the season and there were no high song totals. The behaviour was therefore different from that in Britain. Although the weather was very favourable for the continuation of song, the birds ceased singing about one calendar month before the birds in Britain. The area was one of woodland and small farm clearings, some of which were new. Blair (1936) has already pointed out that the increase of the Yellowhammer in the Far North is associated with increasing cultivation. The area ranged from near sea level in the fjord to about three or four hundred feet up the sides and was surrounded by the mountains of the fjord.

There was strong singing up to 15th July, after which singing rapidly declined. Most of the few songs heard after the 15th were incomplete, the majority consisting of part of the first phrase only. There were two exceptions. A bird which had sung strongly up to the 15th was heard giving 21 strong songs in the afternoon of 23rd July and continued singing as the observer left. This singing was not heard again. In the all-day watch on 27th July (Ref. No. 155) a bird gave 37 songs: these were poor, but many had the terminal phrase. These were the last songs heard during the season, although observations were continued by the author up to 13th August and by K. Pescud up to 23rd August. Adult birds were still feeding fledged young in early August, so the song season finished ahead of the last breeding activities. There was nothing in the weather to cause this cessation of singing. It was mild and mostly dry, with several bright sunny days. Towards the end of July and beginning of August there was drought with hot, brilliantly sunny days; weather very similar to that experienced the previous year in England, when Yellowhammers sang such high totals. This weather produced no songs at all amongst the Arctic birds.

On 5th August 1956, dawn and early morning observations were made by three parties in the Arctic. One party (D. M. Muir, J. K. Muir, N. Varty and the author) was near Škibotn (latitude  $69^{\circ}23'N.$ ) and two separate parties (D. A. Brown and M. A. King; and B. Craddock, K. Pescud and M. A. Vickers) were in Finland (latitude  $69^{\circ}01'N.$ ). None of these parties heard any trace of Yellowhammer song. On the same date Yellowhammers were reported singing strongly at lower latitudes on the mainland of Britain, in Northern Ireland (near Belfast,  $54^{\circ}34'N.$ , M. C. Gray), Denmark (S. Jutland,  $55^{\circ}20'N.$ , C. H. Downes) and Western Germany (near Wuppertal,  $51^{\circ}16'N.$ , P. S. Doull). Amongst the latitudes at which birds were heard singing on the mainland of Britain were  $57^{\circ}38'$  (Deskford, H. Shearer);  $56^{\circ}26'$  (Near Tayport, J. B. Douglas);  $55^{\circ}25'$  (Glanton, T. Gleghorn, P. L. Hunter and L. Rollin);  $54^{\circ}37'$  (Braithwaite, C. Barnes);  $53^{\circ}31'N.$  (Penistone, K. G. Wood);  $52^{\circ}39'N.$  (near Upton, G. A. Gould);  $51^{\circ}43'N.$  (Frocester, S. M. Butlin);  $50^{\circ}52'N.$  (near Findon, A. H. Harris).

## DISCUSSION

It is evident from the figures given, both in the form of all-day watches and song in the first three hours, together with the general observations, that Yellowhammers sang less in late season in Norway than in Britain. Observation also showed that the Arctic birds ceased song a month before the British birds in spite of wholly favourable meteorological conditions for the continuation of song. The most obvious difference in the environment of the two groups is the continuous light in the higher latitudes. This may be one of the factors responsible for the lesser amount of song. The light removes both the night sleep and the enforced day-length which are part of the daily life of birds in lower latitudes. Whilst the birds studied in Britain always had a sufficiently long dark period for night sleep, those studied in Norway had to take their sleep in light, with all the visible hazards and interruptions of a non-dark rest period. It is possible that without night sleep something akin to tiredness may affect the birds. Lack of enforced day-length could affect the internal condition of the bird, which in turn could be responsible for both the reduction in song output and the early termination of the song season. Hutt (1949), speaking of the fowl (*Gallus gallus*) and other species, states that there is a "regression of the gonads after prolonged lighting".

At the latitude at which birds were studied in Britain, song began early in the year on an increasing daylength, but subsequently substantial daily outputs of song were produced after seven weeks of decreasing day-length. Even decreasing day-length therefore appears to be more favourable for Yellowhammer song than continuous light.

In Norway there appeared to be less song competition, another factor which could result in lowered output of song. It seemed that birds were distributed further apart than in Britain, and that there were fewer groups of, say, four or five territories together; more birds appeared to be singing on their own. It must be mentioned, however, that near Skibotn where about five birds were singing together, the output recorded in an all-day watch was still low.

## SUMMARY

1. All-day watches in Britain (latitude *ca.* 55°N.) showed that Yellowhammers may sing very high song totals in August. One bird sang 3,482 songs in one day in August and occupied 12 hours 11 minutes in the singing phase. The high August song totals were correlated with deep dawn penetrations.

2. It was thought that the birds were singing a form of end-of-season mateless song due to the absence or passive behaviour of the hens.

3. Morning song commencement times showed that full dawn penetration (the established period) was not fully developed until





John Warham

BRIDLED TERN (*Sterna anethetus*) INCUBATING; ABROTIOS ISLANDS, W. AUSTRALIA, NOVEMBER 1956. This brings out two of the main differences from the slightly larger Sooty Tern (*S. fuscata*), which is likewise dark above and white below (cf. *auitea*, vol. 1, plates 53-54): firstly, the Bridled Tern has wings and back dark brown, not black, demonstrated here by the contrast with the black crown; secondly, and more useful, the white forehead in the present species is elongated to form a supercilium extending behind the eye (see page 304).

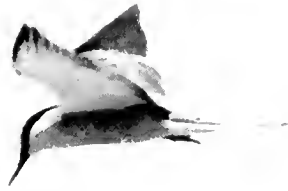

*John Watham*

BRIDLED TERN (*Sterna anaethetus*) FISHING; HAMELIN ISLAND, W. AUSTRALIA  
Bridled Terns are ocean-going birds which come ashore only when nesting. The flight is light and buoyant, and the dark, well-forked tail is noticeable, with the outer edges of the outer streamers white. Food consists mainly of small shoal fish and cuttle fish snatched from near the surface as the bird hovers above the water; this species does not dive and seldom settles on the sea (though it can do so), preferring to find a piece of floating wreckage (see page 305).

June and July. This behaviour is the opposite to that usually found in birds which begin their song season early in the year.

4. Observations in higher latitudes, in Norway between latitude  $63^{\circ}23'N.$  and  $69^{\circ}23'N.$ , from 23rd June to the end of the season, showed that the birds were singing much less than those in Britain. The number of minutes in which birds sang in the first three hours of song averaged about a quarter of that of birds in Britain. A bird in full song in the Arctic in July sang 488 songs in one day.

5. Except for night singing, heard only from a strong singer, the main singing periods in higher latitudes were in Hours 5 to 10 and in Hours 17, 20 and 23.

6. In Arctic Norway song ceased in July, one calendar month earlier than the birds in Britain. This was not due to weather conditions. There was no resurgence of song at the end of the season and no August song.

7. Factors thought to be connected with the lesser amount of song in higher latitudes were the continuous light, the lack of night sleep and the lesser amount of song competition.

#### REFERENCES

- ALEXANDER, H. G. (1938): "A chart of the song periods of British birds", in Witherby *et al.*, *The Handbook of British Birds*, Vol. I, p. xxxix.
- BLAIR, H. M. S. (1936): "Birds of East Finmark". *Ibis*, 1936: 300.
- HUDSON, W. H. (1926): *British Birds*. London. p. 149.
- HUTT, F. B. (1949): *Genetics of the Fowl*. New York. p. 286.
- MONTAGU, G. (1802): *Ornithological Dictionary*. London. Vol. I, Introduction, pp. xxxii-xxxiii.
- MONTHLY WEATHER REPORT (1955): H.M. Stationery Office, London. Vol. 72.
- NICE, M. M. (1943): "Studies in the life history of the Song Sparrow, II". *Trans. Linn. Soc. of New York*, vi: 99-126.
- PARKHURST, R. and LACK, D. (1946): "The clutch-size of the Yellowhammer". *Brit. Birds*, xxxix: 358-364.
- PERRY, R. (1946): *Naturalist on Lindisjarve*. London. p. 77.
- ROLLIN, N. (1945): "Song-Thrush song". *Brit. Birds*, xxxviii: 262-270.
- (1951): "Dawn Chorus in March". *Dawn Song and All Day*, i: 33-41.
- WALLACE, G. J. (1949): "Bicknell's Thrush". (In *Life Histories of North American Thrushes, etc.*, by A. C. Bent). *U.S. Nat. Mus. Bull.*, 196: 212.
- WHITE, G. (1813): *The Natural History of Selborne*. London.

## PHOTOGRAPHIC STUDIES OF SOME LESS FAMILIAR BIRDS

### XCI. BRIDLED TERN

Photographs and text by JOHN WARHAM

(Plates 45-48)

THE BRIDLED, Brown-winged or Panayan Tern (*Sterna anaethetus*), widely distributed in tropical and sub-tropical seas, has been recorded only three times in the British Isles. All were beach-drifted birds—one each at Dungeness, Kent, on 19th

November 1931; at Three Cliffs Bay, Gower, Glamorgan, about 11th September 1954; and at North Bull Sanctuary, Dublin, on 24th November 1953.

Like the very similar Sooty Tern (*S. fuscata*), already dealt with in this series (see *antea*, vol. I, pp. 385-389), this bird nests only on islands. There are colonies in the West Indies, and in the Red Sea and Persian Gulf this is one of the most obvious terns. In the Indian Ocean it is both found in the tropics (Seychelles, Mauritius, Laccadives) and further south breeds at intervals along the whole of the Western Australian coast as far down as Cape Leeuwin. The colonies in the latter neighbourhood are probably the most southerly breeding stations of this species in the world. On the other side of the Indian Ocean the birds nest off the Eritrean coast on islands in Assab Bay and elsewhere (Smith, 1951a). On the West African coast the birds are often plentiful, but no breeding stations are apparently known there. In the Pacific Ocean Bridled Terns breed off the Queensland coast, throughout the islands of Oceania and off the Pacific coasts of Central America. The bird also "breeds on islands in the China Sea from Formosa to Malacca and eastward through the Sunda Islands to New Guinea and Australia" (Whittell and Serventy, 1948).

According to Cott (1953), the Bridled Tern shares with the Sooty and Noddy Terns (*Anous stolidus*) the doubtful honour of being one of the most persecuted of the world's birds for its eggs. Colonies are extensively robbed on the Malayan coast, in Borneo, in the Bahamas and in the Red Sea.

Bridled Terns are ocean-going birds which normally come ashore only when nesting. Outside the breeding season their distribution, like that of the Sooty Tern, is unknown, but they certainly disappear from the vicinity of the nesting islands. Unlike Sooty Terns, however, birds of the present species have water-repellent feathers, so that they can settle on the surface of the sea without harm, though it is seldom that they do so. They will, however, settle readily on floating wreckage.

Bridled Terns are slightly smaller than Sandwich Terns (*S. sandvicensis*) and are wholly dark above and white below. They are very like Sooty Terns but are a little smaller than these and the back and wings are dark brown, not black as in the latter species. These size and colour differences are not very obvious in the field except at close quarters or in good viewing conditions. The brown colouring of the upper-parts is more apparent in sunlight; on dull days wings and back appear blackish.

A useful distinguishing feature is the way in which the white forehead is elongated to a superciliary stripe extending behind the eye (plates 44-47). In the Sooty Tern the forehead band is deeper and extends only as far as the eye, not behind it (*cf. antea*, vol. I, plate 53). Voice differences, too, enable these two species to be separated easily in the field. The normal call of the Bridled Tern

is a staccato "wep, wep" or "wup, wup"—"like the yapping of a small dog or the barking notes of a stilt" (Serventy and Whittell, 1948). This note is quite unlike the normal "wideawake" call of the Sooty Tern, although a rather barking note does feature among the latter's calls on the breeding grounds (Warham, 1956). Bridled Terns also use harsh "scarling" notes when fishing—grating cries rendered as "karr", "k-ow", "kr-arr", etc., by Smith (1951b).

In flight (see plate 48) the dark, well-forked tail is noticeable. The outer edges of the outer streamers are white, and the flight as a whole is light and buoyant. The tips of the wings appear to be responsible for propulsion and their "propeller effect" is quite pronounced. The juveniles are much more typical terns than the young Sooties and have white foreheads and eyebrow stripes—although the crown is not dark as in the adult, but streaked with dull white and brown. The rest of the juvenile's upper-parts are brownish more or less streaked with white, the wings dark brown and the rather short tail feathers tipped with dull white giving them a somewhat toothed pattern. Under-parts and throat are white. Once this juvenile plumage is shed, however, the resulting adult dress and dark head are retained throughout the year.

The Bridled Tern's food seems to consist mainly of small shoal fish and cuttle fish. The bird does not dive but, hovering above the sea, snatches its victims from near the surface and it frequently takes advantage of shoals forced to the top by bigger fish. On their nesting islands, these birds tend to feed in the deeper water away from surrounding reefs and from adjacent coasts.

There is some variation in the breeding season of the various populations of the Bridled Tern. Alexander (1928) gives April-June as egg dates for the northern hemisphere, October-December for those south of the Equator. In Somaliland the birds reappear in coastal waters about mid-April and then leave for their island breeding stations where the season extends from May to August (Smith, 1957). The available evidence suggests that there are two breeding populations of the Bridled Tern along the Western Australian coast (Serventy, 1952). In the south most eggs are laid in November and hatching takes place after mid-January. Thus, on one of the most southerly breeding stations, Hamelin Island, two of the four eggs discovered on 31st December 1955 were "starring". Further north, on Phillip Rock, Rottnest Island, the first egg of that colony's 1955 laying was found as early as 26th October. A. J. Campbell caught an incubating male on the same place on 21st November 1889, and all of the ten or so eggs he collected were fresh (Campbell, 1900). Some 1,500 miles further north, on the hot, arid terrain of Sunday Island, Söderberg (1918) found eggs and young on 8th February 1911, which indicates that at this colony, too, eggs were laid in the October to December period. Serventy's paper, however, suggests that at other colonies, e.g. on the nearby Lacepede Islands, eggs

are laid in May. Thus this tern once again parallels the Sooty in its behaviour since the latter also has a double breeding season in Western Australia as it does in the Central Pacific.

The single egg (stone-coloured, spotted with chestnut and grey) is laid on the bare rock or sand. On sand cays and coral islets it is generally placed under a salt bush, but on limestone stacks a crevice under a ledge or the floor of a cave suffices. Bridled Tern colonies are generally much smaller than those of the Sooty Tern and when the two birds use the same islands the Bridled species is still sitting when the Sooties are mostly tending chicks. Incubation is undertaken by both sexes, but neither the duration of their shifts nor the incubation or fledging period seems to have been recorded.

A stay on Lancelin Island, Western Australia, in October and November 1954, when plate 48 was taken, provided me with an opportunity to witness the return of the Bridled Terns to their breeding grounds. The birds first appeared about 24th October, a small group roosting there at night, but on the 26th the indurated limestone cliffs were suddenly invaded by small parties of these terns during the morning. The birds stayed for an hour or so before returning to sea. More appeared on the following morning and subsequently the middle hours of the day saw hundreds of Bridled Terns thronging the cliffs, occupying potential nesting sites and displaying. Many appeared already paired. At first most of the newcomers left in the late afternoon to roost elsewhere, but, as their attachment to the island grew, more and more remained to sleep in their territories and by the time we left the island on 1st November it seemed that egg-laying was imminent.

The birds were fairly tame and allowed a near approach so that displays could be watched without difficulty. The main patterns noted seem to have much in common with the better known northern hemisphere species and with those of the Sooty Tern.

Three main types of posturing prevailed. Commonest was the typical "parading" where two birds, bodies canted towards each other and folded wings drooping slightly outwards, goose-stepped along side by side or circled around each other, the body feathers were sleeked and each participant averted its head slightly from that of its partner.

"Parading" might lead to a second pattern in which the birds faced each other and waved their lowered bills to and fro without actually allowing them to touch, or their heads might be lifted and the fencing movements would again follow.

Intruders often interrupted these demonstrations, but a third pattern in which both terns, facing each other, made pecking movements towards the ground seemed to be the usual prelude to coition: the presumed female would crouch slightly and allow the male to mount.

The "parade" seemed to contain a strong element of appease-

ment and it was noticeable how each bird turned its nape towards the other while sometimes the participants would lightly touch the backs of each others' heads with their bills. Displaying birds were sometimes seen to pick up and fondle stones or straws in their bills. During the "parading" a short "kek" or "kuk" was used and this changed to a growling "greer, greer" during mutual nodding and bill fencing.

Supplanting attacks were repulsed by the defending birds turning towards the attacker with raised crest (the white bases to the crown feathers are then apparent) and threatening with opened beak. If the intruder was repulsed the defender would then give a peculiar braying call and, since the bill was opened very wide, the vibratory tongue was rather obvious. Fighting birds used a variety of harsh growling cries.

"Dreads" were frequent. They were always triggered off by a special "dread" note—"mer-er-er"—started by a single bird which would dart swiftly seawards with widely swept wings and body canting from side to side, making violent evasive movements as if harried by a hawk. The terns in the neighbourhood would immediately follow suit, flying in the same fashion and uttering the same note. Such "dreads" were usually restricted to that section of the colony nearest the initiating bird and could sometimes be started by quite crude imitations of the special note.

Bridled Terns, like Sooties, tend to be restless after dark and to retire late. On Lancelin Island their barking calls were heard at all hours of the night. Roosting birds slept on low salt bushes and on craggy pinnacles, and one asleep on a wooden post was so dazzled by a torch that it could be picked up by hand.

In addition to the above ground displays there are high-speed aerial flights in which two birds dash across the sky, climbing and swooping in unison. The birds may use normal wingbeats or curiously retarded actions resulting in a kind of "butterfly flight". This display was more often seen on the Abrolhos Islands where the season was further advanced and where the Sooty Terns gave identical performances. As obtains elsewhere when these related species nest on the same islands each had its own area although the types of nest sites were identical. Of the two, the Bridled Terns were more timid and would slip off their eggs well before one was into the nesting colony. The Sooty Terns were more tenacious sitters but would often panic at the last moment, fluttering frantically as they strove to break through the bushes beneath which they had laid their eggs. There was no indication of the aggressive tendencies which Murphy (1936) attributes to breeding Bridled Terns, but perhaps this aggressiveness comes with the hatching of the eggs.

Bridled Terns use similar "comfort movements" to those of other members of their genus. They stretch one wing and leg over the fanned tail, preen frequently, and twisting their heads round to one side rub them on to their shoulders. In scratching

head or beak with a foot they use the direct method, bringing the foot straight up from under the wing: such scratching is quite often carried out when flying.

## REFERENCES

- ALEXANDER, W. B. (1928): *Birds of the Ocean*. New York.  
 CAMPBELL, A. J. (1900): *The Nests and Eggs of Australian Birds*. Sheffield.  
 COTT, H. B. (1953): "The exploitation of wild birds for their eggs". *Ibis*, 95: 643-675.  
 MURPHY, R. C. (1936): *Oceanic Birds of South America*. New York.  
 SERVENTY, D. L. (1952): "The bird islands of the Sahul Shelf". *Emu*, 52: 33-59.  
 ——— and WHITTELL, H. M. (1948): *A Handbook of the Birds of Western Australia*. Perth.  
 SMITH, K. D. (1951a): "On the birds of Eritrea". *Ibis*, 93: 201-223.  
 ——— (1951b): "Notes on the Bridled Tern in the Red Sea". *Brit. Birds*, xlv: 325-326.  
 ——— (1957): "An annotated check-list of the birds of Eritrea". *Ibis*, 99: 1-26.  
 SÖDERBERG, R. (1918): "Results of Dr. E. Mjöberg's Swedish Scientific Expedition to Australia 1910-1913: xviii—Studies of birds in north-west Australia". *Kungl. Sv. Vet. Akademiens Handlingar*, 52, no. 17: 1-116.  
 WARRIAM, J. (1956): "Observations on the birds of Pelsart Island". *Emu*, 56: 83-93.  
 WHITTELL, H. M. and SERVENTY, D. L. (1948): *A Systematic List of the Birds of Western Australia*. Perth.

## NOTES

**Eider's method of eating crabs.**—On 16th December 1957 and subsequent days I had several first-winter Eiders (*Somateria mollissima*) under observation from the pier at Southend-on-Sea, Essex. They were seen diving from a range of a few yards and on returning to the surface, on every occasion, each had a small green crab between its mandibles. The crab was toyed with until two or three legs only were held, and then vigorous head-shaking resulted in the crab's falling into the water less these legs which were hastily swallowed by the duck. The crab was caught again by means of a shallow dive and the above procedure repeated until the body was minus all legs and claws. The body was then swallowed whole and on some occasions this was followed with a small drink of sea water.

It seems probable that the crab was dealt with in this manner in order to prevent considerable damage being done to the bird by the legs and claws on a live specimen. Swallowing would also be difficult.

N. PICOZZI

**Attempted coition between House Martin and Sand Martin.**—I was very interested to read Mr. Bernard King's note (*antea*, pp. 121-122). During a long study of Sand Martins (*Riparia riparia*) at Rosebank, Lanarkshire, I have one record of attempted coition between this species and a House Martin (*Delichon urbica*), on



13th June 1955. This was the only case I saw in six years of watching this colony and it followed very closely the description given by Mr. King.

A number of Sand Martins were flying over a field, sometimes settling on the ground, and they were accompanied by a few (approximately four) House Martins. I then noticed one of the House Martins was hovering over a Sand Martin resting on the ground and I watched it settle on the latter's back. For about two seconds the Sand Martin's wings were quivering and the other's flapping and then both birds flew off. P. E. D. COOPER

**Magpie's rapid replacement of dead mate.**—In late March 1956, I shot one of a pair of Magpies (*Pica pica*) which had a completed nest in a pine tree in my garden at Rugeley, Staffordshire. Two days later the survivor had a new mate and introduced it to the completed nest, in which they eventually reared a brood successfully.

In March 1957, Magpies again built a nest in the garden, this time in the next pine tree to the 1956 nest. At 07.00 hours on 30th March I shot one of the pair—I think the female. The other bird was very distressed all the morning, but at about 14.00 hours I was surprised to see that it had already found a new mate. The two birds seemed very excited, hopping around in the trees and making a great deal of noise, and by late afternoon they were both visiting the nest frequently.

Rapid mate replacement in birds of prey has been recorded before on several occasions, but it does not appear to have been recorded in Magpies. This, of course, does not mean that it is not a common thing, and in fact a local farmer tells me that he has seen it before. However, seven hours seems a remarkably short time for replacement. C. D. T. MINTON

**Cock Blackbird feeding juvenile Song Thrush.**—About midday on 22nd May 1958, at Rendcomb, near Cirencester, Gloucestershire, I watched an adult male Blackbird (*Turdus merula*) feed a juvenile Song Thrush (*T. philomelos*) six times within a period of ten minutes. Between feeds the young thrush busied itself among the plants of a flower-bed and discovered several items of food for itself. The Blackbird collected food at distances up to thirty yards and then sought out the bird of the other species to push the collected material into its mouth. The Song Thrush showed no apparent begging attitude but accepted the food the moment the other bird arrived. The Song Thrush was full-grown but in obvious juvenile plumage. CHRISTOPHER M. SWAINE

**Chiffchaff and Whitethroat taking insects from water.**—On the morning of 5th April 1958 three inches of snow fell in west Kent and I was able to observe some interesting and unusual feeding

behaviour by a Chiffchaff (*Phylloscopus collybita*) and a White-throat (*Sylvia communis*).

The two birds were sitting in willow branches about six inches above the surface of a ballast water outside Sevenoaks and I was watching their activities from the top of a sand cliff, thirty feet above them. They were constantly flying out over the water and would momentarily hold their wings motionless over their backs as they glided just above the surface and picked off insects, making a contact ring each time they touched the water with their beaks. After catching an insect each would return to the nearest branch to eat it. Through glasses it was possible to see the insects on the water and watch them being eaten, but it was not possible to identify them.

I do not know which bird had first discovered this unusual method of feeding, but both were working close together, sheltered by the sand cliff from the driving snow, and they continued to do so for over an hour. JEFFERY G. HARRISON

**Tree Pipits feeding nestling Skylarks and removing faecal sacs.—**

On 2nd June 1956 Mr. G. Thomason and I had under observation a Skylark's (*Alanda arvensis*) nest, containing four small young, at Astmoor, near Runcorn, Cheshire. The adult Skylarks were visiting the nest every two or three minutes with food. About 200 yards away a pair of Tree Pipits (*Anthus trivialis*) had a nest, also with young, and these birds were collecting food in the area of the Skylark's nest. Whenever the pipits came within approximately six feet of the latter, the adult Skylarks would drive them away, but on two occasions when the larks were absent we saw the pipits feed the young and also remove faecal sacs. R. P. COCKBAIN

[There are many instances, in the literature, of birds feeding other young of their own or other species, but we do not know of any records involving Tree Pipits and it is interesting to note the nest-sanitation.—Eds.]

**Abnormal growths on the legs and feet of Chaffinch and Blackbird.—**On 2nd February 1958, I trapped a female Chaffinch (*Fringilla coelebs*) and on 2nd March 1958 a male Blackbird (*Turdus merula*), both of which had abnormal growths on their right feet.

The growth on the Chaffinch was of a tough rubbery texture and covered almost the entire right foot. On the upper surface of the growth were a number of wart-like protrusions which, although pliable, could not be removed. The only parts of the foot which were not completely enveloped by the growth were the claws of the middle, outer and hind toes. The tarsus of the infected leg, although wafer thin, was 3 mm. from front to back and brick-red in colour. I considered that it was inadvisable to ring the bird and I released it in the hope of being able to watch its

behaviour on the ground. However, it was joined immediately in the air by a male Chaffinch and both quickly flew out of sight.

In the Blackbird the growth was a hard, round swelling at the base of the hind toe which was considerably thicker than the other toes. This growth was yellow in colour and covered with small, pale brown spots. The whole of the toe was twisted round so that the claw was curved upwards.

Comparison with the growths on Dunnocks (*Prunella modularis*) described by G. R. Edwards (*antea*, vol. xlvii, pp. 186-187) suggests that the one on the Blackbird may have been of the same type, especially in view of the swollen toe. But the shape of the tarsus on the Chaffinch implied a more permanent and perhaps different kind of growth.

A. D. TOWNSEND

**Green Singing Finch living "wild" in Hampshire.**—The article by Mr. Derek Goodwin on "The problem of birds escaping from captivity" (*antea*, vol. xlix, pp. 339-349) was of particular interest to ornithologists visiting Hengistbury Head, Hampshire, in the autumn of 1957, because of the occurrence of a Green Singing Finch (*Serinus mozambicus*) there over a period of nearly three months.

The bird was first sighted by myself on 11th August and was then seen at virtually every visit by many observers until 3rd November. It was, in fact, at first taken to be a male Serin (*S. canarius*) in particularly good plumage, but after correspondence with Dr. J. S. Ash the mistake was realised. I was then able to confirm the identification by reference to Mr. Goodwin's article and was pleased to note that all the identifying features mentioned by him (unforked tail, lack of markings on the under-parts, distinctive head markings and general "clean" appearance) had been noted when the bird was first seen clearly.

It is noteworthy that the bird lived a normal "wild" life during the whole of its stay and that it was far from tame, being much less approachable than, for instance, the resident Chaffinches (*Fringilla coelebs*). On 31st August, whilst it was being watched by Mr. and Mrs. Edwin Cohen, R. J. Jackson and myself, the bird was seen to be carrying twigs to the top of a tall conifer. This apparent attempt at nest construction was continued all that afternoon and the bird was later seen in company with a Linnet (*Carduelis cannabina*), but the presumed courtship was not noted at later visits.

F. R. CLAFTON

## REVIEWS

THE BIRDS OF THE BRITISH ISLES. By D. A. BANNERMAN. Illustrated by G. E. Lodge. (*Oliver and Boyd*, Edinburgh), Vol. VI (1957): 326 pages; 26 colour plates. Vol. VII (1958): 256 pages; 27 colour plates. £3 3s. each.

THE SIXTH VOLUME describes the storks, herons, Flamingo, swans,

geese and shelducks—a total of 30 species. Volume seven covers the remainder of the Anatidae, with 32 accounts including Black Duck and Ring-necked Duck. The Baikal Teal is treated in square brackets, the author adding, “I feel that *Anas formosa* should not appear on the British List under the circumstances related above”. The Mandarin Duck is not mentioned.

In many of the plates Mr. Lodge achieved a gracefully spacious impression by allowing the birds themselves to cover only a relatively small portion of each picture. Some idea of a bird's surroundings and a suggestion of its habits are an often neglected part of ornithological illustration.

Dr. Bannerman acts as much as editor as author and in preparing the text has again drawn upon the experience of a very large group of experts specializing in the species concerned; among his more important contributors in these volumes are Prof. G. J. van Ordt on the Spoonbill and Bewick's Swan in Holland, R. A. H. Coombes on geese and Shelduck, Dr. H. M. S. Blair on a number of ducks, and Lord William Percy on Steller's Eider. He welds the whole together with his wide personal knowledge, acquired from many overseas travels, particularly in Mediterranean and African areas. In addition to articles specially written for this work, much information has been gathered from an extensive circle of correspondents. We learn for example that it is practically certain that a pair of Little Bitterns succeeded in rearing a brood in southern England in 1947 and may have done since, a Whooper Swan nested about 1927 at 2,200 feet near Loch Ness, more than 1,000 Wigeon were killed by a single punt-gunner in 1948, and Scaup bred in Scotland in 1956.

For a more complete idea of the general treatment and lay-out the Pink-footed Goose may be considered—a bird which the author is firmly convinced should be regarded as a full species and not as a race of the Bean Goose. The account runs to 16 pages: it starts with identification, then local distribution in Great Britain in winter, distribution abroad, habits in Britain, habits abroad and nesting. In this last section an account of Spitzbergen comes from the unpublished diaries of J. H. McNeile, for Greenland there is a resumé from Salomonsen's *Birds of Greenland*, George Yeates contributes a special article on the classic breeding ground of the Pink-foot in Iceland, and there is an abbreviated account of the Wildfowl Trust expedition to central Iceland.

Naturally enough it is from published literature that the bulk of the material is skilfully drawn. It results at times in a certain scattering of information and in some repetition, but it also often gives an admirable picture, surprising at times, of relative abundance in various parts of the overseas range of a number of species. Perhaps not least of the many charms of the book is its unexpectedness—one never really knows what one will find in it. It is a fascinating mine of information very well worth digging into.

P.A.D.H.

A BIRD WATCHER IN KENYA. By VERNON D. VAN SOMEREN. (*Oliver & Boyd*, Edinburgh, 1958). 270 pages; 32 plates incorporating 38 photographs in monochrome. 30s.

BIRDS IN KENYA have in the past been dealt with mainly by the gun and the systematist. There have been honourable exceptions, but little has been written for the non-specialist reader. This book, by a member of a family whose ornithological associations with Kenya are strong, does much to fill the gap between the standard works of reference and those books of more general and entertaining approach, of which British birds have encouraged many but the African avifauna few.

The African canvas is broad, but Mr. van Someren has swung away from the traditional approach to nature in Kenya and breaks refreshingly new ground. To say that he treats most of the species mentioned in the book domestically is not to detract from the wealth of individual observations which the author has amassed. The result of this approach is an entertaining series of ornithological cameos figuring species as different as Jackson's Whydah and Crowned Crane. One doubts whether the author puts these forward as scientific studies of breeding behaviour, but the chapter on the Fiscal Shrike comes near to this and all succeed as pleasant journals of their subject's breeding habits and other behaviour.

With such a kaleidoscope of observations and this method of treatment, Mr. van Someren has written a book in detailed sections rather than as a composite whole. Thus it may remain hard for the British reader to grasp the proper context and incredible luxury of bird-watching in Kenya. The author, while expressly limiting himself on this point, forgets his text on several occasions and the hints he then lets fall are tantalizing. It would be unfair to criticize Mr. van Someren too strongly over this, for especially where he deals more generally with the birds of Mount Kenya and Lake Magadi he does succeed in conveying the thrill of the unfamiliar. The book is obviously not intended for "bird swallows", but the reader must guard against expecting an ornithological feast.

Bird-photography today is an exact science and a hard master. Mr. van Someren shows well the versatility of the miniature camera, explaining why he prefers photography at the nest and pointing out the difficulties to those who would follow his example in East Africa. One plate will attract special attention, that of Ibis Point on Lake Magadi: it stands out because what it conveys is as important as what it portrays. Kenya is a primitive and very exciting land, and to watch birds there is to have many demands made on one's attention. Mr. van Someren has obviously exercised discipline in not being side-tracked by the better bird that is always in the next bush and is to be congratulated on a book which lets us approach African birds more intimately than any other yet written.

D.I.M.W.

Forestry Commission Leaflets: No. 36—THE CROSSBILL, by BRUCE CAMPBELL (1955, 10 pages, 9d.); No. 37—THE CAPERCAILZIE, by C. E. PALMER (1956, 10 pages, 9d.); No. 41—THE CRESTED TIT, by BRUCE CAMPBELL (1958, 12 pages, 1s.). Published by Her Majesty's Stationery Office, London.

THESE ATTRACTIVELY PRODUCED glossy leaflets, each illustrated with between five and eight first-rate photographs by well-known personalities, conform to the high standard set by the Forestry Commission for its publications. They form part of a series dealing mainly with the diseases and pests of British woodland—"Income Tax and Death Duties" is appropriately one of the others—and the treatment is scrupulously fair.

Of the Crossbill it is stated that, although its primary food is coniferous seed, the bird is insufficiently numerous to cause the slightest alarm to foresters. The biological problems posed by irruptions from Europe are mentioned.

The Capercaillie—D. G. Andrew has shown (*antea*, p. 191) how the spurious "z" spelling arose—is in a different category, as it is sometimes undoubtedly harmful. Where there is a heavy concentration of birds in young coniferous stands, considerable damage is caused to leading buds, resulting at the least in a serious loss of annual growth. Under conditions such as this, control by shooting may be necessary. Nevertheless, "provided it does not become unduly numerous in the younger plantations, this interesting and beautiful bird may be tolerated and even encouraged".

Dr. Bruce Campbell, who is a forester by training and an ornithologist by profession, summarizes concisely what is known of the Crested Tit and more especially the Scottish race. There is no suggestion that this delightful bird is in any sense a nuisance in the forest; indeed the leaflet has as its object simply to draw attention to an outstandingly interesting inhabitant of the Caledonian pinewoods about which much has still to be learnt. For instance, does the Scottish population, for so long cut off from its relatives, have the same habit as birds in Norway of storing pine seeds in autumn for winter use? W. J. EGGELING

## RECENT REPORTS AND NEWS

By I. J. FERGUSON-LEES and KENNETH WILLIAMSON

**The items here are largely unchecked reports, and must not be regarded as authenticated records. They are selected, on the present writers' judgment alone, from sources generally found to be reliable. Observers' names are usually omitted for reasons of space and in case a report is subsequently rejected, and none of the items will be mentioned in our annual Index. Readers are asked to submit anything of interest as quickly as possible.**

The earlier parts of this summary are mainly concerned with the month of July and the first half of August, a period which

sees a trickle of returning summer-migrants grow into a steady but still small stream. Then the last section includes a number of late May and June reports, and therefore to that extent overlaps with our summary in the July issue (*antea*, pp. 277-284).

During the last two months we have received several detailed lists referring back to the March/early May period: these all fit very well into the general picture of the spring movements already given, and we have thought it best not to refer to them now as it becomes rather tedious to continue harping back on former happenings. Therefore only a few particularly interesting earlier links are mentioned. We are, however, extremely grateful to these people who have sent in belated summaries, as indeed we are to all our contributors who have helped to make this feature a success: we only regret that it is impossible to mention names individually, a fact which will be appreciated when it is realised that one summary this year was based on the reports of nearly 400 people!

#### THE CROSSBILL INVASION

As already briefly mentioned (*antea*, p. 284), it became abundantly clear at the beginning of July that an "irruption" of Crossbills (*Loxia curvirostra*) was in progress. Many reports have reached us, nearly all of comparatively small flocks of 15-30 birds or less, and as these are still coming to hand it would be premature to attempt to depict the pattern of the invasion and subsequent spread. However, a few preliminary remarks can be made in the hope that they will stimulate observers who have not done so to send in their records.

The report of 200 on the island of Rhum, Inner Hebrides, on 20th June remains the earliest date and much the biggest number yet sent to us. The species was first noted at Fair Isle, and also in Shetland, on 27th June, and an increase at Fair Isle on the 29th may be linked with the second peak of 200 at Rhum on the next day. Crossbills seem to have disappeared from the northern isles about 11th July.

Apart from 6 at Clumber, Nottinghamshire, on 26th June, there are so far no reports of any in English localities until 2nd July, when a party was seen at Boars Hill, Oxford, and some began to arrive at Lundy, North Devon. However, in Wales about 18 were present at Trecastle, Breconshire, from 29th June. A spread to inland localities seems to have taken place in the west about 3rd July, since on that day parties of 6 and 8 were seen near Raglan, Monmouthshire, and at Cheadle, Cheshire, respectively, the latter feeding avidly on seeds of wych elm. From this day, too, until the 6th there were about 20 at Spurn Bird Observatory, Yorkshire. By the 6th Crossbills appear to have become quite widespread in the south of England, and they had penetrated to many inland localities by the 9th. There was a definite movement on the Dorset coast on 10th-11th July, perhaps connected with a second peak at Lundy at this time and with passage during the

9th-12th at Herm in the Channel Islands. There were rather fewer reports after 26th July and it seemed that the majority had passed on by this time, though small groups were still present in some counties, particularly in the west (Westmorland, Lancashire, Herefordshire, Oxfordshire), during the first half of August.

There have been extremely few records of Crossbills from Scotland, other than from the northern isles, but from 24th July flocks were about at Strathtay, Perthshire, where Crossbills have been very scarce in the past few years. A party which appeared on Unst, Shetland, on 24th July may have been on passage from the Faeroe Islands.

As usual in the case of "irruptions", most birds are either females or young and very few "red" males have been reported. We shall be glad to receive any information bearing upon this invasion, and when the flow of records ceases it will be time to see what pattern emerges from an analysis of the material. In conclusion, it is worth noting that several observers from this country attending the XIIth International Ornithological Congress in Finland in June, the writers included, remarked upon the enormous numbers of Crossbills moving west in various localities from about 14th June, but particularly in the last twelve days of that month. The "irruption" was noted in Denmark from 19th June, and Crossbills were unusually numerous in Spain in July.

#### THE RETURNING WADERS AND OTHER MIGRANTS

There was a trickle of returning waders from the last days of June, and Whimbrels (*Numenius phaeopus*) were particularly commented on in quite a number of areas right through July: single birds were seen on Skokholm, Pembrokeshire, as early as 30th June and 1st and 4th July, and several inland counties were reporting this species about the middle of the month. Greenshanks (*Tringa nebularia*), Green Sandpipers (*T. ochropus*) and Common Sandpipers (*T. hypoleucos*) were also moving in some numbers from the very beginning of July, as well as a few Wood Sandpipers (*T. glareola*) and Ruffs (*Philomachus pugnax*): 9 Ruffs at Nottingham sewage farm on 6th July were still in breeding plumage, and single Ruffs in Co. Derry on 27th and 31st July are regarded as unusually early for Ireland. Green Sandpipers reached a peak in the last ten days of July and as many as 40 were reported from Northampton sewage farm by the 27th. At Nottingham the waders included Turnstones (*Arenaria interpres*) on 26th and 27th July, with 5 on 8th August, and a Knot (*Calidris canutus*) on 2nd August—two of the less common species inland, though there were also 5 Turnstones inland at Chew Valley reservoir, in Somerset, on 10th August. At the Isle of May, Firth of Forth, Turnstones arriving from the third week of July had built up to about 400 by 5th August, an unusually large number for that date; and these and 30-40 Purple Sandpipers (*Calidris maritima*) with them were mostly in breeding plumage.



A sprinkling of Black Terns (*Chlidonias niger*) occurred throughout July, 2 at Abberton, Essex, on the 13th being the earliest reported, while 11 at Chew, Somerset, on the 19th and 75 at Cliffe, Kent, on the 20th were the largest numbers of which we have heard. Little Gulls (*Larus minutus*) have also been in evidence: the first-summer bird which appeared at Hanningfield, Essex, on 22nd June (*antea*, p. 282) was still present on 13th July and a second-year one was noted at Teesmouth, Co. Durham, on the 10th; at the latter place there were two adults in full plumage on the 17th and one on the 18th; Kent (Dungeness) and Buckinghamshire (Dorney Common) also produced full adults on 26th July and 6th August respectively; and one of three at Weymouth, Dorset, on 11th August likewise still had a totally black head. The Buckinghamshire bird was still present on 17th August. (Not far away, at Ham Island sewage farm, Old Windsor, Berkshire, a Little Gull that was thought to be the same individual spent several weeks in each of three successive autumns, 1954-56, and appeared for one day in 1957.) After early August, reports of Little Gulls became, as always, much more frequent: these included an immature at Hilbre Island, Cheshire, on the 13th (the species is much less common on the west coast).

Very little information has been received on the return movements of Passerines, though, to give examples from opposite sides of the country, the first signs of warbler passage were noted at Skokholm, Pembrokeshire, and Sandwich Bay, Kent, on 22nd-23rd and 30th July respectively. An autumn roost of Yellow and Pied Wagtails (*Motacilla flava flavissima* and *M. alba yarrellii*) in a reed-bed at Sandwich Bay had already reached a nightly total of up to about 250 birds by 20th July.

#### RARER BIRDS IN JULY AND EARLY AUGUST

An immature White-tailed Eagle (*Haliaeetus albicilla*), hotly pursued by several Great Skuas (*Catharacta skua*), was seen on Unst, Shetland, on 8th July, and a Buzzard (*Buteo buteo*) was noted again at Fair Isle on the 13th (*cf. antea*, p. 284). An immature Glaucous Gull (*Larus hyperboreus*) at Hilbre Island, Cheshire, had by mid-August almost completed a year there, a stay which rather overshadowed that of the one in the Cley area (*antea*, p. 281), for the latter was not seen after the end of June. However, we now learn that the north Norfolk coast had a second Glaucous Gull during the summer: this was considered to be a year older and apparently ranged between Blakeney Point and Overstrand; it was picked up dead at Cley on 3rd August. (Two other rather late Glaucous Gulls had remained in the Teesmouth area, Co. Durham, up to 27th May.)

A Squacco Heron (*Ardeola ralloides*) observed on the River Exe near Bampton, Devon, on 16th and 17th July may or may not have been the one that was seen elsewhere in Devon in early June (*antea*, p. 281). The Isle of May produced a Subalpine Warbler (*Sylvia cantillans*) which was trapped on 16th July and remained

until the 23rd, when it was recaptured in poor shape and then died; this was the third Subalpine in Scotland this year (*antea*, p. 284). On the day it first appeared there was also a Turtle Dove (*Streptopelia turtur*) on the island: this is an irregular visitor to most of Scotland, though a pair had been seen at Troup Head, Banffshire, on 1st June. A Spotted Crake (*Porzana porzana*) was heard at Walberswick, Suffolk, on 22nd July and about this time (probably the 21st) an adult Crane (*Megalornis grus*) was shot at Lough Beg, Co. Derry, in Northern Ireland. An adult Rose-coloured Starling (*Sturnus roseus*) was discovered at Fair Isle on the 29th and was still to be seen on 4th August, but a Little Bustard (*Otis tetrax*) that was picked up with a broken wing at Compton, near Newbury, Berkshire, on 28th July was less fortunate and died on 1st August. A Purple Heron (*Ardea purpurea*)—thought to be a first-summer bird—at Wilstone reservoir, Tring, Hertfordshire, first attracted attention on 30th July and had been seen by a number of observers by 11th August, the latest date we have so far: it spent much of its time in a reed-bed, but emerged for short flights at intervals. A second immature Purple Heron was seen in N. Kent on the first two week-ends in August, and another southern bird, a Bee-cater (*Merops apiaster*), was watched at Beddington, Surrey, on the 5th. The first American bird of the autumn, a Lesser Yellowlegs (*Tringa flavipes*), appeared on the Exe estuary in Devon on 10th August.

The Breydon Spoonbills (*Platalea leucorodia*) (*antea*, p. 281) were still present on 9th July, but the one at Hanningfield, Essex, was not seen after the 2nd. Hanningfield, however, had other birds of interest during the month of July, including 5 drake Common Scoters (*Melanitta nigra*) on the 5th and its ever-present Shag (*Phalacrocorax aristotelis*) (*antea*, p. 282) which was still to be seen on the 19th. But most noteworthy of all there, in view of previous remarks on the subject (*antea*, pp. 132 and 239-241), was the appearance of three Ruddy Ducks (*Oxyura jamaicensis*), one an adult male, on this latter date. Another inland Shag was reported from King George VI reservoir at Staines, Middlesex, on 13th July, when it was seen with four Cormorants (*Ph. carbo*); at this reservoir an adult and an immature Shag had also been "left over" from the early spring movements (*antea*, p. 131) and had remained until at least the end of May. There were a number of reports of single Common Scoters inland in various parts of the country during July.

#### EARLY MOVEMENTS OF SEA-BIRDS

To complete the July picture, mention must be made of the early movements of certain sea-birds which are indicated by observations on the Durham and Yorkshire coasts, and to a lesser extent elsewhere. A total of 14 Arctic Skuas (*Stercorarius parasiticus*), mainly immatures, were seen flying south at Hartlepool, Co. Durham, on 5th July and this is quite an unusual date; single birds were noted on 6th and 13th in the same area. These and two

adults at Langstone Harbour, Farlington, Hampshire, on 28th June are perhaps to be connected with an unusual inland record on 19th July, when a dark phase adult was watched over the River Test in Hampshire, near Milbrook. Similarly, two Great Skuas were flying in a northerly direction at Hartlepool on 4th July and single ones were noted there and at Redcar (Yorkshire) on the 6th. On 24th June at least 10 Manx Shearwaters (*Procellaria puffinus*) were flying north-west at Redcar, as were 25 on 5th July and 2 on the 6th, while at Hartlepool there was one on 22nd June, 3 on 5th July, 11 on 6th, 18 on 19th and a few on the 29th. Single Great Northern Divers (*Gavia immer*) and Red-throated Divers (*G. stellata*) on several occasions in June and July off this north-east coast, and one or two Red-breasted Mergansers (*Mergus serrator*)—including a pair that summered off Hartlepool until 19th July—were other interesting observations, which, though not so very remarkable individually, combine to suggest unusual movements. It would be interesting to know how far up and down the coast they were noted.

As a tailpiece, it may be added here that over 500 Leach's Petrels (*Oceanodroma leucorhoa*) were ringed on the N. Scottish island of North Rona in June and early July—roughly twice the Ringing Scheme's previous grand total of this species in 50 years—and one of these has already been recovered on St. Kilda.

#### FURTHER UNUSUAL BIRDS IN MAY AND JUNE

A number of interesting reports for May and June (and two for April) were received too late for inclusion in our last summary. Yellow-browed Warblers (*Phylloscopus inornatus*) are seldom recorded in spring, but one was well authenticated in Devon on 7th and 8th April; there is at least one previous spring record (May) for that county. Single Kites (*Milvus milvus*) near Post-bridge, Devon, on 3rd May and over Shepherd's Bush, London, on 20th May are particularly noteworthy in view of the several other reports of this species in March, April and May (*antea*, pp. 164, 207-208 and 280). And an Avocet (*Recurvirostra avosetta*) at Belvide, Staffordshire, on 20th May should also be mentioned in connection with earlier occurrences (*antea*, p. 207). An immature Bewick's Swan (*Cygnus columbianus bewickii*), with an injured wing, stayed at Alvecote, Warwickshire, until 28th May, a very late date, but more significant was the pair of adult Whooper Swans (*C. cygnus*) which were still present at a former breeding-ground in N. Scotland on 30th June.

A drake Red-crested Pochard (*Netta rufina*) at Abberton reservoir, Essex, on the unlikely date of 1st June was perhaps an escape, but the possibly changing status of this species (*antea*, vol. L, p. 543) should be remembered. The only spring report of Bee-eaters to reach us in 1958 came from Dale Fort, Haverfordwest, Pembrokeshire, where several observers watched two flying in a westerly direction on 31st May, on which day an Ice-

land Gull (*Larus glaucoides*) was seen at Thurso, Caithness (*cf. antea*, p. 282). Caithness also produced a female White-winged Lark (*Melanocorypha leucoptera*) near Loch Scarmeleth on 8th June—a species not previously reported from Scotland—and a single adult Crane at Westerdale from 12th to 15th June. Incidentally, with regard to the surprisingly numerous previous reports of Cranes in 1958, it is interesting to note that one was seen flying south between the Midrips and Rye, Sussex, on 7th April, just two days after an immature had been observed at Saltwood, Kent (*antea*, p. 207). A Lesser Grey Shrike (*Lanius minor*) was seen near Crail, Fife, on 8th June—only one week after there had been one at Fair Isle (*antea*, p. 283). An adult male Little Bittern (*Ixobrychus minutus*) was located in Somerest on 21st June and was still being seen regularly in the same locality seven weeks later.

From 25th to 28th June there was a male Red-headed Bunting (*Emberiza bruniceps*) on North Rona off N. Scotland: this followed a period of cyclonic north-east wind off the coast of Norway, but this species is still a commonly imported cage-bird (see *antea*, vol. xlix, p. 341) and the origin of individuals reported in the British Isles remains a matter of opinion (see discussion in vol. xlvi, pp. 75-76).

Finally, as an addition to previous remarks on Turnstones and Sanderlings (*Crocethia alba*) inland (*antea*, pp. 251-252), we learn that a single Turnstone was at Cannock reservoir, Staffordshire, on 25th May, when there were also 11 Sanderlings; single Sanderlings there on 3rd June and at Alvecote pools, Warwickshire, on 21st May complete the picture.

#### A QUAIL YEAR?

We have had a number of reports of Quail (*Coturnix coturnix*) from southern localities, and more would be welcome. This is obviously a "Quail year" in the northern islands, from which the species has been absent for many years. There has been one bird, possibly a pair, at Baltasound in Unst, Shetland, all the summer, and it is believed that 3 or 4 are present on Fair Isle, though despite attempts to find nests breeding has yet to be proved.

... Now Ready ...

## BIRDS OF THE BRITISH ISLES

Volume VII

David A. Bannerman and  
George E. Lodge

The latest volume of this great work deals with the dabbling, or surface feeding, and the diving ducks. Species described include the mallard, gadwall, teal, garganey, wigeon, pintail, shoveler, pochard, goldeneye, eider, seoter, goosander, merganser, smew and the white-eyed, tufted, ring-necked, buffle-headed, long-tailed, harlequin and scaup ducks. There are 27 colour plates of bird paintings by the late George E. Lodge.

Price 63s. net



## A BIRD WATCHER IN KENYA

Vernon D. Van Someren

In this book the author conveys to the reader some of the pleasure and satisfaction that may be derived from both bird watching and bird photography. The text contains much valuable information, and the author demonstrates to the full the capabilities of the 35 mm. camera. The book is illustrated with 38 photographs taken by the author.

Price 30s. net



Send for Bird Book List to

**Oliver and Boyd**

**Tweeddale Court,  
Edinburgh, 1.**

## SPEND YOUR HOLIDAYS IN A BIRD WATCHERS' PARADISE

---

### PLACE MANOR

---

Nestling in the lush Sub-Tropical vegetation of St. Anthony-in-Roseland, on the edge of lovely Percuil Creek, with its own five safe sandy Bathing Beaches. This peaceful spot the outside world has never known; is a haven of rest for countless numbers of our birds.

Open all the year round. Ideal for a Winter Holiday: **THERE IS NO REAL WINTER IN ROSELAND.**

Terms from £5 5s. per week, all found. Write for Illustrated Brochure to O. Hartc, Place Manor, St. Anthony-in-Roseland, Portscatho, Truro. Phone Portscatho 256. Enclose medium-sized stamped addressed envelope.

---

### ON THE GLORIOUS CORNISH COAST

---

#### SMALL ADVERTISEMENTS

---

**BINOCULARS AND TELESCOPES.** New and used. Descriptive lists and expert advice on request. Exchanges, overhauls. J. R. Hebditch, F.B.O.A., F.S.M.C., 44 Hallgate, Doncaster.

---

9 x 40 Wrayvu Binocular £18/18/0, exchanges, repairs, lists. Bass & Bligh, 18, Market Arcade, Leeds 1.

---

**BINOCULARS AND TELESCOPES,** new and reconditioned, at reasonable prices. Approval allowed, also part exchanges. Lists from Hatton Optical Co. Ltd., Lansdowne, Bournemouth, Hants. (Established 1930).

---

**BINOCULARS AND TELESCOPES,** repaired, cleaned and adjusted; send your instrument for estimate by return. Hatton Optical Co. Ltd., Lansdowne, Bournemouth, Hants.

---

Mr. & Mrs. D. A. T. Morgan are leaving Suffolk. To the many friends they have made in the last 7 years they extend their thanks. Perhaps we'll meet again some day.



SS 12×60

BLOOMED LENSES



The Meopta quota is the only importation of Czechoslovakian binoculars to enter Britain.

Binoculars with a magnification of 12× are the automatic choice of the professional ornithologist. A lower magnification lacks the power for long range observation. Combined with the light gathering power of a 60 mm. object lens, a binocular with a magnification of 12× is the ideal for the professional and the amateur ornithologist.

The construction of a 12 × 60 binocular does present technical difficulties not encountered in the manufacture of the smaller types, notably the elimination of irritating colour fringe, and the usual price is about £70.

The Meopta 12 × 60, with the rare combination of high magnification and brilliant light gathering power, has a complete absence of colour fringe and represents a remarkable achievement in binocular construction.

The price, including the leather case and lanyard, is

**£31 10s. 0d.**

Sole distributor in the United Kingdom,

**THOMAS PARRY**

52, KNIFESMITH GATE,  
CHESTERFIELD.

Telephone 4906

37, SOUTH MOLTON ST.,  
LONDON, W.1.

Telephone : Mayfair 3167

Personal callers welcomed.

*Otherwise Cheque or Money Order crossed, payable THOMAS PARRY, should accompany your name and address, BLOCK LETTERS PLEASE. Binoculars cannot be sent on approval, but satisfaction or full cash refund guaranteed.*

# BRITISH BIRDS



SEPTEMBER 1958

THREE SHILLINGS

# BRITISH BIRDS

AN ILLUSTRATED MONTHLY MAGAZINE

Edited by

E. M. NICHOLSON

W. B. ALEXANDER                      A. W. BOYD

I. J. FERGUSON-LEES

P. A. D. HOLLON                      N. F. TICEHURST

*Editorial Address:* 30, St. Leonard's Avenue, Bedford.

*Photographic Editor:* G. K. YEATES

Annual Subscription £2 (including postage and despatch)  
payable to H. F. & G. Witherby Ltd., 5, Warwick Court, London, W.C.1

---

---

## CONTENTS OF VOLUME LI, NUMBER 9, SEPTEMBER 1958

---

	PAGE
An ecological sketch of the Camargue. By Dr. L. Hoffmann (with contributions from R. Lévêque, P. Aguesse and L. Bigot). Photographs by G. K. Yeates and Dr. L. Hoffmann (plates 49-60) ... ..	321
Migrant land-birds in the Western Approaches. By Ivor McLean and Kenneth Williamson ... ..	351
Obituary: William Stanley Cowin (1907-1958) ... ..	353
Notes:—	
Little Shearwater in Cheshire (C. G. Bennett, A. W. Boyd and N. W. Cusa) ... ..	354
Great Tit killing and carrying Goldcrest (J. L. Caris) ... ..	355
Thrush Nightingale and probable Nightingale at Fair Isle, and the problem of identification (Peter Davis and Peter Hope Jones) ...	356
Nestling Goldfinch's decomposed body rotting feet off rest of brood (Miss Eileen M. Palmer) ... ..	357
North American birds staying on board ship during Atlantic crossing (R. MacArthur and P. Klopfer) ... ..	358
Reviews:—	
<i>Curious Naturalists.</i> By N. Tinbergen ... ..	358
<i>L'Art Français dans Le Livre d'Oiseaux.</i> By René Ronsil ... ..	360
Recent reports and news. By I. J. Ferguson-Lees and Kenneth Williamson ... ..	361

---

Cover photograph by G. K. Yeates: male Penduline Tit (*Remiz pendulinus*) building nest, Camargue (see pages 321-350)



VOL. LI  
No. 9

SEPTEMBER  
1958



## BRITISH BIRDS

---

---

### AN ECOLOGICAL SKETCH OF THE CAMARGUE

By L. HOFFMANN

(*Station Biologique de La Tour du Valat,  
par Le Sambuc, Camargue*)

With contributions from  
R. LÉVEQUE, P. AGUESSE and L. BIGOT

(Plates 49-60)

#### INTRODUCTION

THE RHONE, creator of the Camargue, is born among glaciers and continues as a mountain torrent in its upper reaches, yet long before it touches the Camargue it becomes merely a large gently-flowing river. Lyons, 310 kilometres from its mouth, is only 169 metres above sea-level, so in its last 300 km. the river averages a fall of hardly more than 50 cm. per kilometre. This means that all its heavier loads have been deposited long before it comes to the delta. It drops nothing more there except fine silt; natural stones are found nowhere in the Camargue, even at considerable depth. All the superficial beds down to at least 20 metres consist of alluvial silt or fine sands. But this applies only to the middle of the delta. If we pass eastwards, across the Grand Rhône we suddenly find ourselves in the Crau, on pebbles. We reach here the alluvial zone of the Durance, a great mountain torrent which hurls itself directly down from the Alps on to the coastal plain, and which has everywhere laid down great pebble deposits.

If, on the other hand, we pass westwards from the centre of the delta we meet increasingly sandy surfaces. To understand their origin requires a summary knowledge of the winds of the Camargue. The prevailing wind is from the north-west, coming down from the Massif Central, and is called the *mistral*. It is generally a very strong wind, often blowing for several days. The wind second in importance is from the west, moderate but some-

times quite strong and also blowing often for several days. Both these winds are accompanied by dry sunny weather, but the third, from the south-east, comparable to the Italian *sirocco*, is humid and brings rain. It is much rarer than the other two, but can sometimes attain considerable force. Winds coming from inland thus largely dominate those blowing from the sea, and for this reason the silt deposited by the Rhône has stayed on the surface without being covered with sand by winds from the shore. Yet as the delta has gradually advanced into the sea it has created a peninsula, the western shore of which runs north and south in some places. In such places the west wind can shift some of the coastal sands inland. Such is the origin of the dunes of Beauduc and L'Espiguette, and by similar means much of the Petite Camargue has become covered in sand.

To the visiting ornithologist, the Camargue appears an island of virgin soil in the midst of a country long devoted to intensive cultivation. It has, all the same, during the last two centuries undergone changes, directly or indirectly through human action, which have completely transformed it. Nothing of the present ecology of the Camargue can be understood without appreciating this fact. From ancient evidence it emerges that the Camargue was more widely cultivated than in more recent times and was regarded as a wheat granary of Provence. A varying number of arms of the Rhône intersected the delta, fertilizing the soil by periodic floods and washing part of the salt out to sea. The embanking of the Grand Rhône, begun towards the close of the 18th century, much extended the tracts of salt-steppes and saline lagoons which now appear to us so characteristic of the Camargue. It is nearly certain that the avifauna changed considerably in consequence of this recent ecological evolution.

Today salt is the dominant influence in the Camargue. It is all-powerful on the lower parts, the lagoons and *sansouires*, flooded during part of the year, lying nearly at sea-level. In the next zone of marshes and steppes, about 1 metre above sea-level, it reveals itself only in the ground-water and through capillary action on the surface. Its influence is almost absent only in the northernmost and highest parts of the delta, some 2-3 metres above sea-level. But these parts are today almost entirely under intensive cultivation and no longer have any "Camargue" appearance.

From these geological and historic facts results the present aspect of the Camargue, marked by two series of zonations—one from north to south derived from the growing saline influence and one from west to east as sand gives way to silt and silt to pebbles. If in this account we treat in order each Camargue habitat, starting from the sea and going towards zones less and less saline, we must afterwards consider also the modifications which we shall find eastwards and westwards through the influence of pebbles and sand.

## SUCCESSION OF HABITATS

We find the following succession of principal habitats:

(1) Shore.

(2) Coastal dunes, with rather sparse vegetation, dominated by marram grass (*Ammophila arenaria*), between which rainwater often maintains moist "slacks" for fairly long periods. Some of the dunes of the sandy Petite Camargue are capped by pinewoods of stone pine (*Pinus pinea*). (See plate 49 top.)

(3) Low-lying *sansouire*, a plain partly subject to seasonal flooding and covered with glasswort (*Arthrocnemum* and *Salicornia*). A system of brackish pools, temporary or permanent, mostly intercommunicating, intersects this plain, which is totally uninhabited. In its midst rises a ridge of old dunes, the Bois des Rièges, composed chiefly of Phoenician junipers (*Juniperus phoenicea*) and pistachio (*Pistacia lentiscus*). Part of the *sansouire* is today transformed into salt-pans. (See plates 49 centre and bottom, 52 upper and lower; also *antea*, vol. I, plates 79 and 80.)

(4) Upper *sansouire*, a dry steppe, flooded only in its lower parts during winter, dominated firstly once more by *Salicornia*, which, however, yields place as the salinity diminishes to a more varied plant community dominated by sea-lavender (*Statice* spp.) and some grasses, notably *Brachypodium phoenicoides*; this is rapidly colonized by philaria (*Phillyrea angustifolia*)—a sort of wild olive shrub—which sometimes forms small thickets. All over this steppe are found scattered pools of weak or very weak salinity, sometimes reed-grown, sometimes with open water, and generally encircled by tamarisks (*Tamarix gallica*). Here and there it is also cut by artificial drainage channels, along which tamarisks have become established, and, where the supply of fresh water is constant, these are replaced by elms (*Ulmus campestris*) and white poplars (*Populus alba*). Most of this zone is now cultivated, this being the one which has suffered most during the past decade or so from reclamation for ricefields. (See plates 55 upper, 57 and 58; also *antea*, vol. I, plate 71.)

(5) The dry and stony Crau, sparsely covered with vegetation, in which grasses and strongly aromatic herbs predominate. At the slightly moister fringes of the Crau the kermes oak (*Quercus coccifera*) and evergreen oak (*Quercus ilex*) form spinneys or in places actual woods at their limit of range towards the silty Camargue. (See plate 60.)

(6) Agricultural zone, composed chiefly of ricefields, vineyards and meadows, which today occupies nearly all the northern part of the delta as well as the raised belts following the old or existing arms of the river. (See plate 55 lower.)

(7) Riverside forest, mostly subject to seasonal floods, and composed chiefly of white poplar, white willow (*Salix alba*), alder

(*Alnus glutinosa*), and ash (*Fraxinus oxyphylla*), and also in the driest parts elms and downy oaks (*Quercus pubescens*). This forest attains in places a tropical density with privet (*Ligustrum*), dogwood (*Cornus sanguinea*), hawthorn (*Crataegus oxyacanthus*), *Amorpha fruticosa* and brambles (*Rubus* spp.), etc. (See plate 53.)

#### THE SHORE

Between Le Grau-du-Roi near Aigues-Mortes and Fos-sur-Mer near Port-de-Bouc a beach of fine sand stretches for nearly 100 kilometres, interrupted only by the two mouths of the river, by a certain number of *graus* (former river mouths now linking lagoons with the sea) and by the village of Saintes-Maries-de-la-Mer. The coast is in general fairly shallow—in the Golfe de Beauduc it is even necessary to go out nearly a kilometre to reach a depth of one metre. A belt of dry sand separates the sea, when it is calm, from the dunes and the *sansouires*. This belt is only a few metres wide at some points, but broadens to some hundreds of metres at others.

Only two birds regularly nest along this shore or in its immediate vicinity: the Kentish Plover (*Charadrius alexandrinus*) and the Oystercatcher (*Haematopus ostralegus*). However, the Common Tern (*Sterna hirundo*), the Little Tern (*Sterna albifrons*) and the Herring Gull (*Larus argentatus*) throughout the nesting season commonly search for food in the shallow water along the seashore and even breed occasionally at some spots. A curious fact, only discovered in the past few years, is that some little parties of Eiders (*Somateria mollissima*) spend the whole year along the shore near the mouth of the Grand Rhône. No breeding has, however, been proved so far.

#### THE DUNES

The coastal dunes form an almost continuous belt behind the shore of the Camargue, less than 100 metres broad for a great part of their length, but going back to a depth of several kilometres in the Petite Camargue and round the Pointe de Beauduc. They cover about 50 sq. km. and their highest points rise to 9 metres above sea-level in the Petite Camargue and to 7 metres at Beauduc. These dunes are the most important in the western Mediterranean, but are small compared with certain coastal dunes of the Atlantic and Baltic. Marram grass and a legume, *Medicago marina*, are dominant, but there are plenty of other herbaceous plants so that in May and June these places are made attractive by a varied carpet of flowers. Some pools of water remain during a great part of the year in the middle of the dunes and thus permit certain animals to find a niche there.

These dunes harbour a fairly rich insect fauna dominated by Coleoptera (beetles) and burrowing Hymenoptera (ants, bees and wasps). From the end of May to July swarms of Orthoptera (grasshoppers) attract certain of the Laridae, especially Gull-billed Terns (*Gelochelidon nilotica*), Black-headed Gulls (*Larus ridibundus*) and Herring Gulls. Among reptiles and batrachians

we should note the presence of the Ladder Snake (*Elaphe scalaris*), the Spanish Sand Lizard (*Psammmodromus hispanicus*) and the Southern Mud Frog (*Pelobates cultripes*). Among mammals are the House Mouse (*Mus musculus/spicilegus*), Rabbit (*Oryctolagus cuniculus*) and Fox (*Vulpes vulpes*), while Wild Boar (*Sus scrofa*) sometimes penetrate to these places.

There are only two species of birds which nest regularly in and are characteristic of the dunes. They are the Short-toed Lark (*Calandrella cinerea*) and the Tawny Pipit (*Anthus campestris*). This poverty in species during the breeding season, however, gives place to a varied avifauna at times of migration. This is particularly true for the spring, since all sorts of birds, above all small Passerines, having crossed the Mediterranean, discover here the first sheltering vegetation and the first fresh water. One finds here then birds belonging to very different habitats, even birds of the shadiest forests such as, for example, the Wood Warbler (*Phylloscopus sibilatrix*) and others. On the few spots where there are some trees—chiefly *Eleagnus*, pine and elm—Magpies (*Pica pica*), Kestrels (*Falco tinnunculus*) and Corn Buntings (*Emberiza calandra*) breed.

A part of the dunes of the Petite Camargue is covered with woods of stone pines, with an under-storey of such shrubs as Phoenician junipers, pistachio, philaria and some herbaceous plants, such as *Daphne gnidium*, *Cistus salviaefolius*, *Asphodelus cerasifer* and *Rosmarinus*. These woods are colonized by a number of species absent from the treeless dunes. Among these we should note a reptile such as the Green Sand Lizard (*Lacerta viridis*), and a mammal such as the Badger (*Meles meles*). The most spectacular of the birds are the different colonial-nesting species of heron: Little Egrets (*Egretta garzetta*), Night Herons (*Nycticorax nycticorax*) and a few pairs of Squacco Herons (*Ardeola ralloides*). Hobbies (*Falco subbuteo*) nest there also, as well as Carrion Crows (*Corvus corone*), Sardinian Warblers (*Sylvia melanocephala*), Nightingales (*Luscinia megarhynchos*) and Goldfinches (*Carduelis carduelis*). The Black Kite (*Milvus migrans*), the Sparrowhawk (*Accipiter nisus*), the Nightjar (*Caprimulgus europaeus*) and the Long-eared Owl (*Asio otus*) are probable breeders in that part, although no nest has so far been found. This habitat is poorly covered ornithologically and a more systematic study would certainly reveal several more Passerine nesting species.

#### THE LOW-LYING SANSOUIRE AND THE SALINE LAGOONS

This habitat, with those parts of it modified by exploitation as saltpans, extends over all the lower parts of the delta behind the shore and the coastal dunes. It covers about 500 sq. km. between Le Grau-du-Roi and Fos-sur-Mer, and nearly all the Reserve, including the Etang du Vaccarès, is in this zone.

##### (a) *The Arthrocnemum glauci*.

Most of the higher ground emerging during the greater part of the year carries a vegetation almost entirely composed of glass-

wort (*Arthrocnemum glaucum* = *Salicornia macrostachya*). The clusters of these plants cover roughly 50-80% of the soil, letting the bare silt appear between them.

This zone is very poor in species, and generally also in individuals. Among invertebrates only some beetles (Coleoptera) and spiders (Lycosidae) have a certain importance. Coleoptera of the genera *Cicindela* and *Bledius* sometimes even swarm, and probably thus attract some birds. Some reptiles and mammals are encountered in these habitats, but they are simply animals from neighbouring habitats coming there on the prowl.

Only four species of birds nest in this vegetation and only one of those, the Skylark (*Alauda arvensis*), occurs almost throughout. Two of the others, the Short-toed Lark and the Yellow Wag-tail (*Motacilla flava*)\*, have only a somewhat local distribution in the neighbourhood of the upper *sansouire*. The fourth species, the Kentish Plover, on the other hand prefers the parts most denuded of vegetation.

Around depressions the *sansouire* becomes more and more denuded, and it is there submerged during the greater part of the year by saline or sometimes super-saline water. Its invertebrate fauna is thus that of the lagoons and may attract large flocks of waders or ducks to make a halt.

(b) *The saline lagoons.*

The vegetation forms, by contrast, large floating masses in the lagoons themselves, in which masses the dominant species is *Ruppia maritima*. It is in the most southerly lagoons that this vegetation is densest; proceeding northwards the waters become less saline and other varieties of *Ruppia* are found. The young shoots appear at the beginning of spring; at its close comes the flowering, covering the surface of the lagoons with a lively yellow; fruiting follows during the summer. The seeds accumulate consequently on the bed of the marsh. The invertebrate fauna, essentially concentrated on the masses of *Ruppia* as well as on the abundant brown algae on the edge of the lagoons, is relatively poor in species but rich in individuals. Both in the southern and the northern lagoons we find numerous amphipods (*Gammarus locusta*) and isopods (*Sphaeroma hookeri*). In the most saline lagoons occur also some polychaete worms (*Nereis diversicolor*) and molluscs (cockles, *Cardium* spp., and *Paludestrina* spp.). It is above all at the end of spring and the beginning of summer that this fauna abounds.

Marine fish which occur sparsely in the less saline lagoons (*Mugil capito*, *Morone labrax*, etc.) exist side by side with such freshwater species as Carp (*Cyprinus carpio*) and Pike Perch (*Lucioperca lucioperca*). Eels (*Anguilla anguilla*) swarm every-

\*The Ashy-headed race (*M. f. cinereo-capilla*) meets the Spanish form (*M. f. iberiae*) in S. France, and much of the Camargue population is intermediate (see N. Mayaud, 1952, *Alauda*, vol. xx, pp. 1-20; and M. Schwarz, 1956, *Orn. Beob.*, vol. 53, pp. 61-72).—Eds.

where. The 22 following species have been proved to live in this zone during the last few years :

(a) 7 species of freshwater origin :

Perch ( <i>Perca fluviatilis</i> )	Carp ( <i>Cyprinus carpio</i> )
Pike Perch ( <i>Lucioperca lucioperca</i> )	Gambusia ( <i>Gambusia affinis</i> = <i>holbrocki</i> )
Pike ( <i>Esox lucius</i> )	Stickleback ( <i>Gasterosteus aculeatus</i> )
Catfish ( <i>Ameiurus nebulosus</i> )	

(b) 15 species of marine or saline origin :

Pilchard ( <i>Sardina sardina</i> )	Grey Mullet ( <i>Mugil cephalus</i> )
Eel ( <i>Anguilla anguilla</i> )	Thin-lipped Grey Mullet ( <i>Mugil capito</i> )
Gar-fish ( <i>Belone belone</i> )	Smelt ( <i>Atherina mochon</i> )
Pipe-fish ( <i>Syngnathus abaster</i> )	Plaice ( <i>Pleuronectes platessa</i> )
Sea Perch ( <i>Morone labrax</i> )	Brill ( <i>Scophthalmus rhombus</i> )
Dorado ( <i>Chrysophrys aurata</i> )	Turbot ( <i>Scophthalmus maximus</i> )
Goby ( <i>Gobius</i> sp.—? <i>minutus</i> )	Sole ( <i>Solea</i> sp.—? <i>vulgaris</i> )
Golden Grey Mullet ( <i>Mugil auratus</i> )	

The breeding avifauna of this zone is almost entirely concentrated on some islets in the lagoons. These islets are inhabited by big mixed colonies of Black-headed Gulls, Common Terns, Little Terns, Gull-billed Terns, Sandwich Terns (*Sterna sandvicensis*), Avocets (*Recurvirostra avosetta*) and some Redshanks (*Tringa totanus*). Pairs of Roseate Terns (*Sterna dougallii*) or Slender-billed Gulls (*Larus genei*) nest irregularly in these colonies. In the middle of the islets, in the most tussocky vegetation, are found nests of Mallard (*Anas platyrhynchos*), Gadwall (*Anas strepera*) and Red-crested Pochard (*Netta rufina*), and, more irregularly, of Shoveler (*Spatula clypeata*) and Pintail (*Anas acuta*). Often a clutch of duck's eggs contains eggs of two or three different species. Herring Gulls, Kentish Plovers, Oystercatchers, Black-winged Stilts (*Himantopus himantopus*) and Shelduck (*Tadorna tadorna*) often join these colonies, but are also found, in greater isolation, here and there on the islands, banks, etc. On islands with tussocky vegetation Yellow Wagtails, Spectacled Warblers (*Sylvia conspicillata*) and Skylarks make their nests.

In spring and autumn great flocks of waders stay on passage in the saline lagoons. These birds must feed on amphipods (*Gammarus*) and isopods (*Sphaeroma*), but doubtless also frequently on *Nereis*, on molluscs, on crustacean plankton and even on seeds of *Ruppia*. Black-tailed Godwits (*Limosa limosa*), Ruffs (*Philomachus pugnax*), Dunlins (*Calidris alpina*), Grey Plovers (*Charadrius squatarola*) and Ringed Plovers (*Ch. hiaticula*) are the most abundant species. With the waders, great flocks of duck also begin to arrive to pass the winter in this zone. Wigeon (*Anas penelope*), Teal (*A. crecca*), Mallard, Gadwall and Shoveler are the most numerous species in these flocks.

Large numbers of Cormorants (*Phalacrocorax carbo*) inhabit the saline lagoons from autumn to spring; many of these that have been shot or found dead have been carrying Dutch rings. They

fish in the sea and in the saline lagoons and rest on the shores of the islets or on posts in the water. The Flamingo (*Phoenicopterus ruber*) is common throughout the year, although less numerous in winter. The Little Egrets and the Purple Herons (*Ardea purpurea*) come here in summer, the Common Herons (*Ardea cinerea*) from late summer to spring. The large herons, like the Cormorants and the gulls, feed particularly in the saline waters, on fish such as Eels, mullets and flat fish, while the egrets prefer crustaceans, insect larvae and small fish such as *Atherina*, *Gobius*, *Gambusia*, etc.

During winter all this zone is largely submerged following the great rains of October and November which pour on to the Camargue the greater part of its annual precipitation. It dries progressively during spring and summer and in early autumn reaches a minimum waterlevel which often allows the salt to crystallize in a good part of the lagoons before the rains begin again in September or October. The cycle repeats itself every year, but the amounts are very variable. In the most recent years, however, everything has been changed since the discharge of the canals draining the ricefields maintains during the whole year a much higher water level, sometimes approximating to that of winter. One no longer finds nowadays the great dry shores of Vaccarès and the other lagoons, and still less the ponds, so dried up as to lead to crystallization of the salt.

(c) *The salins or salt-pans.*

Around the Salin de Giraud and in the Petite Camargue an important part of the saline lagoons has been transformed into industrial salt-pans. Sea-water is introduced there and is concentrated in embanked lagoons and guided towards the crystallization surfaces. One can, then, observe a gradation of salinities; some lagoons have a salt concentration close to that of the sea, while others have concentrations much higher than 100 gm./litre.

The flora, in the least saline lagoons, is still dominated by *Ruppia maritima* which flourishes there as in the more saline ones, but fruits less and less well. When the concentration is highest, only threadlike green algae survive.

While the invertebrate fauna in the least concentrated pools is similar to that of the brackish ones (*Cardium* spp., *Paludestrina* spp., *Nereis diversicolor*, *Gammarus locusta*, etc.), that of the pools richest in salt is very special; one only meets, in these extreme conditions, very few species, but the number of individuals is considerable. Thus the swarms of a phyllopod, *Artemia salina*, are very spectacular. Larvae of Diptera (*Ephydra* spp., Chironomidae), as well as a dytiscid beetle, *Potamonectes cerisyi*, also abound in these places.

It is only in spring and summer that this invertebrate fauna is abundant; during autumn and winter these waters are almost totally devoid of fauna and flora alike. Fishes are numerous only



in pools of almost marine salinity; these are all sea fishes. Only small species such as the Smelts (*Atherina mochon*) and gobies (*Gobius* spp.) penetrate into the more saline pools.

The avifauna of the *salins* is essentially the same as that of the brackish waters. It should be noted, however, that it is here that the Flamingos nest, and find very good feeding conditions from spring to autumn. For the Avocet also the *salins* provide a very good habitat during the breeding season. However, if the brackish waters are rich in avifauna during the whole year and especially in winter, the *salins* by contrast are rich only during the summer months: waders on passage are numerous there at the end of spring, from late April until the beginning of June, and the earlier part of the autumn passage is particularly spectacular; between these two periods broods of gulls and terns and of the southern waders are abundant there. Yet from October until March this habitat is almost completely birdless, while the natural brackish lagoons hold a very rich avifauna all through the winter. This is supported then for the most part by seeds of *Ruppia*, by small animals which manage to maintain themselves within the shelter of the aquatic vegetation or by fishes. These three resources are lacking in the super-saline pools.

(d) *The Bois des Rièges.*

An old chain of dunes rises like a little archipelago in the midst of the low *sansouire* to the south of the Etang du Vaccarès. It is known under the name of Bois des Rièges and, for the admirer of virgin landscapes and the botanist, is one of the most exciting parts of the Camargue. The Bois des Rièges are composed mainly of Phoenician junipers (plate 52 upper) reaching a height of six metres and mingled with other tall shrubs such as pistachio, alaternes (*Rhamnus alaternus*), philaria, etc. They shelter a fairly rich herbaceous vegetation, including such superb flowers as asphodels (*Asphodelus cerasifer*), narcissi (*Narcissus tazetta*) and pancratium (*Pancretium maritimum*). Some pools of water remain there most of the year. Like the vegetation the fauna of the Bois des Rièges resembles that of the wooded dunes of the Petite Camargue. The avifauna, however, is less rich, and the abundant Sardinian Warbler and the omnipresent Nightingale, with the Magpie, Kestrel and Red-legged Partridge (*Alectoris rufa*), are the only regular nesters.

(e) *The bird colonies on the islets.*

The group of birds most characteristic of this brackish zone is undoubtedly that of the Flamingos and the Lari-limicolines nesting on the islets. The habit of nesting on these islets puts these birds out of reach of predatory mammals, of which the Fox is the most formidable. We have several times noted that islets joined up again with the land through summer desiccation have been rapidly and completely pillaged by Foxes. The number of the islets is fairly limited in the lagoons of the Camargue, and not all

are suitable for nesting. Little islands need to be sheltered from the *mistral*, and must therefore be in the north-western parts of the larger lagoons or in small marshes. In other places only islets large enough to avoid total submersion, despite the full force of the wind, can offer hospitality to breeding birds, which are then massed chiefly on the south-eastern or central parts of the islets, best sheltered against waves. For these reasons there are not more than about forty islets occupied by bird colonies, of which more than half are in the *salins*. A single colony may consist of anything from a few tens to several thousands of pairs.

Among the gulls and the Avocet—species typical of these colonies—the Herring Gulls lay first, beginning at the end of March, followed by Black-headed Gulls towards mid-April and Avocets towards the end of the month. The Herring and Black-headed Gulls establish themselves in the dense *Salicornia* shrubs, while the Avocets seek bare hollows in the interior or a few sheltered shores (plate 50 lower). Starting from the beginning of May, Gull-billed Terns (plate 50 upper), Sandwich Terns, Common Terns and, towards the middle of the month, finally the Little Terns lay their eggs. These species establish themselves in the transition zone between the vegetation and the bare shores, the Little Tern even on denuded shores which emerge from the beginning of May. The Flamingos, which make a colony on their own, install themselves on an island where there are no other species except the Herring Gulls, and lay about 20th April, sometimes even up to some weeks earlier. All the Camargue Flamingos usually nest in a single colony (plate 51).

Among the ducks, which nest often in great concentrations in the midst of the roughest vegetation on the islets, the Mallard begins laying from March, while the Gadwall and the Red-crested Pochard hardly lay before the beginning of May. Other species more or less closely accompanying this procession are the Kentish Plover, which starts to lay sometimes before mid-April, and the Redshank, Oystercatcher and Shelduck at the end of the month.

The different species concentrated on the same islet for nesting purposes are nevertheless ecologically very distinct, as is shown by the places to which they go for food. Only the Flamingo, the Avocet, the Redshank and the Shelduck feed themselves entirely in the zone of the brackish lagoons. The Kentish Plover and the Oystercatcher have their principal habitat there but often venture on to the seashore. All the other species are essentially attached to habitats other than the brackish pools. The Common, Little and Sandwich Terns and the Herring Gulls feed along the shoreline and even offshore, while the Black-headed Gulls and Gull-billed Terns and the three ducks forage over freshwater habitats or even dry land (see Fig. 1).

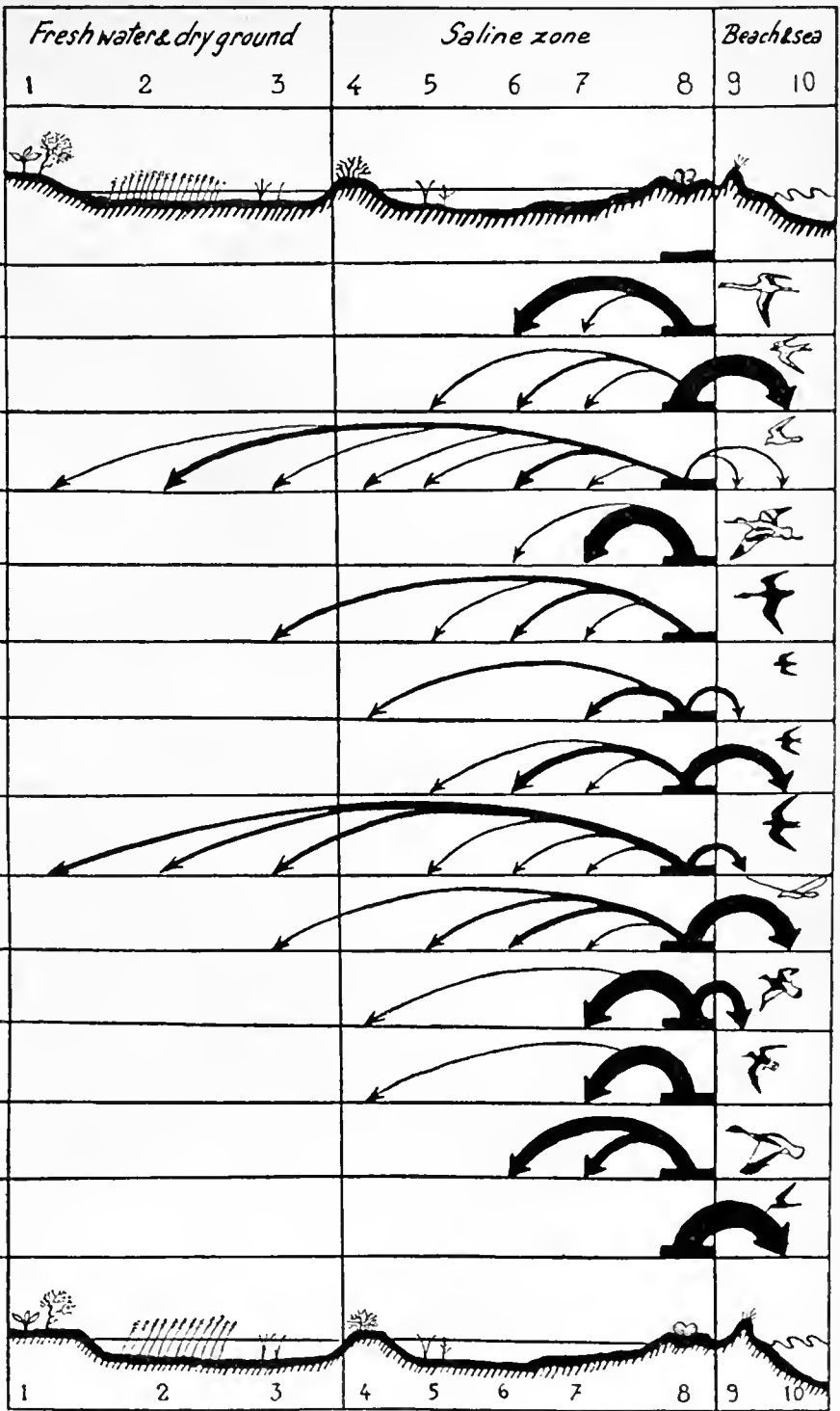

FIG. 1.—THE FEEDING GROUNDS OF THE BIRDS BREEDING ON ISLANDS IN THE SALINE LAGOONS. Column 8 represents the nesting islets in a simplified cross-section of Camargue habitats, and the relative thicknesses of the arrows for each species indicate the extent to which the bird concerned uses the other zones for feeding. These other zones are numbered as follows: (1) dry ground and cultivation; (2) ricefields; (3) swamps; (4) salt-steppe; (5) pools of low salinity (5-15 gm. per litre); (6) saline pools (15 or more gm. per litre) less than 10 cm. deep; (7) saline pools (15 or more gm. per litre) more than 10 cm. deep; (8) nesting islets; (9) dunes and beaches; (10) sea.

FIG. 2.—from a drawing by J. A. Valverde in *La Terre et La Vie*, 1957, p. 174, which was based on a sketch by R. Lévêque)

On the average of the years 1955-57 the numbers of pairs nesting in the brackish zone were approximately:

Flamingo ( <i>Phoenicopterus ruber</i> )	4,000
Black-headed Gull ( <i>Larus ridibundus</i> )	3,000
Common Tern ( <i>Sterna hirundo</i> )	2,000-3,000
Avocet ( <i>Recurvirostra avosetta</i> )	600-800
Duck—Mallard ( <i>Anas platyrhynchos</i> )	) Several hundreds altogether
Gadwall ( <i>Anas strepera</i> )	
Red-crested Pochard ( <i>Netta rufina</i> )	
Kentish Plover ( <i>Charadrius alexandrinus</i> )	Several hundreds
Little Tern ( <i>Sterna albifrons</i> )	300-400
Gull-billed Tern ( <i>Gelochelidon nilotica</i> )	300
Herring Gull ( <i>Larus argentatus</i> )	About 150
Redshank ( <i>Tringa totanus</i> )	50-100
Oystercatcher ( <i>Haematopus ostralegus</i> )	50-100
Shelduck ( <i>Tadorna tadorna</i> )	50 individuals, nesting pairs?
Sandwich Tern ( <i>Sterna sandvicensis</i> )	20-40
Roseate Tern ( <i>Sterna dougallii</i> )	Sometimes a pair
Slender-billed Gull ( <i>Larus genei</i> )	Sometimes a pair

These figures are very variable for the Common, Sandwich and Little Terns, species which forage mainly in the sea. This may be due to the great variability in the numbers of small fish along the Camargue coast. Thus the total of Common Terns hardly exceeded 500 in 1955, but was some 3,000 in 1956.

#### THE UPPER SANSOUIRE AND THE MARSHES

This zone—situated between the low *sansouire* and the arms of the river or neighbouring ground—constitutes the raised part of the Camargue. It occupies an area of about 750 sq. km., between Aigues-Mortes, Saint Gilles, Arles and Fos-sur-Mer.

##### (a) *Salicornietum fruticosae*.

The low parts of this zone, lying generally near sea-level and under moderately brackish water during winter, are again occupied by *Salicornia*, but of the species *Salicornia fruticosa*, which is more tufted and bushy than the *Arthrocnemum glaucum* of the low *sansouire*. This is accompanied by some other halophilous plants, such as sea purslane (*Obione portulacoides*) and sea lavender (*Statice limonium*), and also by the graminaceous *Glyceria festucaeformis*. The proportion of bare soil is reduced to less than 20%. The invertebrate fauna is again sparse, though considerably richer than in the *Arthrocnemetum glauci*. Most prevalent are again beetles (Coleoptera) and spiders (Arachnida), but fair numbers of Heteroptera and Isopoda, and especially molluscs, are also present. This association is less halophile than the *Arthrocnemetum glauci*, but needs more humidity and even winter flooding. The *Arthrocnemetum* occurs only on a few higher and drier parts of the upper *sansouire*, where more salt is concentrated through capillarity and evaporation. On the other hand, the *Salicornietum fruticosae* occurs in the low-lying *sansouire* near only moderately brackish water. Fig. 2 presents a cross-

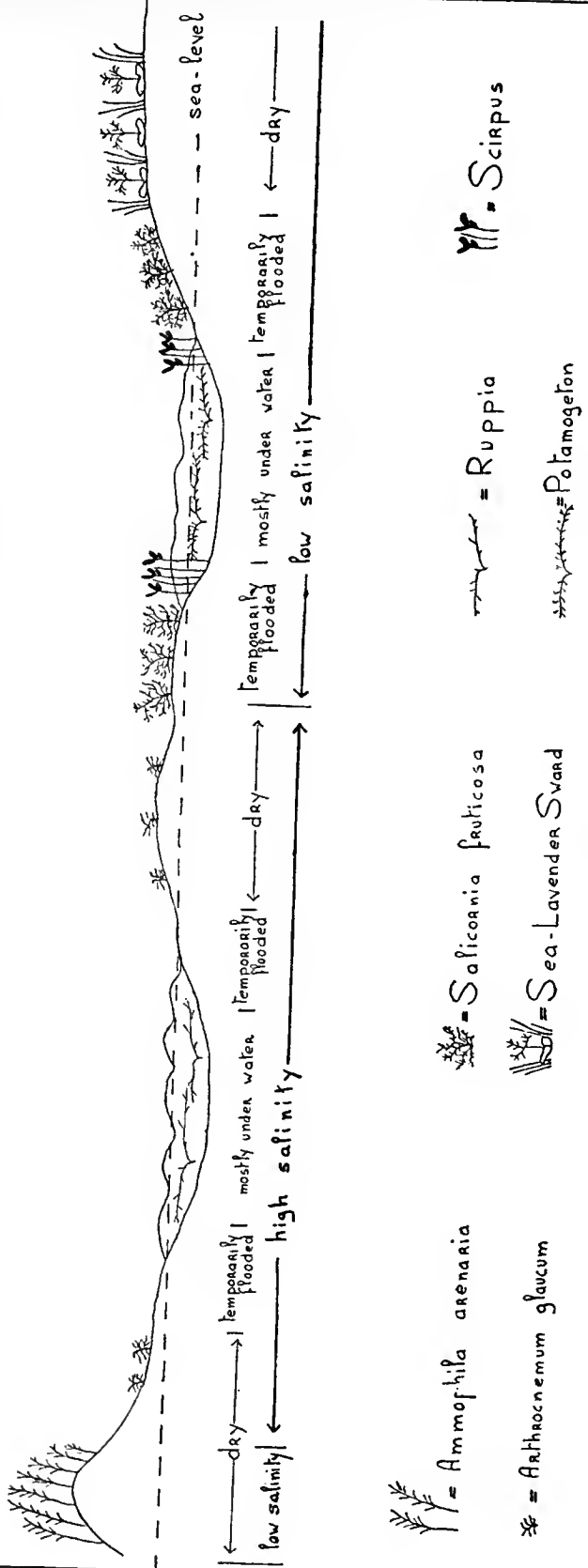

FIG. 2.—CROSS-SECTION FROM DUNES TO SEA-LAVENDER SWARD, TO SHOW THE DISTRIBUTION OF SALICORNIA AND ARTHROCNEMUM. High salinity + dryness gives rise to *Arthrocnemum glaucum*, low salinity + moistness to *Salicornia fruticosa*. Lagoons (*étangs*) of high and low salinity have the following plant successions:

- |                          |                            |   |
|--------------------------|----------------------------|---|
| Permanent parts          | High salinity              | Low salinity  |
| Temporarily flooded zone | <i>Ruppia</i>              | <i>Potamogeton</i> or <i>Phragmites</i>                                 |
| Surrounding dry ground   | Bare ground                | Low parts <i>Scirpus</i> ; higher parts <i>Salicornietum fruticosae</i> |
|                          | <i>Arthrocnemum glauci</i> | Sea-lavender sward  |
- (Drawn by Miss M. Gallegra from a sketch by L. Hoffmann)

section inland from the dunes to show the distribution of the *Salicornia* and the *Arthrocnemum*.

The Spectacled Warbler (plate 56 left) and the Yellow Wagtail are the two most characteristic nesting birds and, with the Skylark, the most abundant in this zone. In parts with poor plant cover, Short-toed Larks, Crested Larks (*Galerida cristata*), Tawny Pipits, Pratincoles (*Glareola pratincola*) (plate 57 centre), Lapwings (*Vanellus vanellus*) and Kentish Plovers breed as well. Red-legged Partridges and Stone Curlews (*Burhinus oedicnemus*) also nest sometimes in the *Salicornia*, although they are more characteristic of the sea-lavender sward.

(b) *The sea-lavender sward.*

The *Salicornietum fruticosae* is followed, on the higher, drier and less saline surfaces, by the sea-lavender sward. Its vegetation is both denser and richer in species. It completely covers the ground and is dominated by some halophytes, of which sea-lavenders (*Statice limonium* and *virgatum*), sea purslane (*Obione portulacoides*) and shrubby seablite (*Suaeda fruticosa*) are most notable. But there is also a large variety of xerophytes, both grasses and many flowering plants such as, for instance, dandelion (*Taraxacum officinale*), daisy (*Bellis annua*), *Inula viscosa*, *Myosotis intermedia*, *Geranium rotundifolium*, etc. The highest parts of the sea-lavender sward, uninfluenced by salt, are covered with groups of *Phillyrea angustifolia* shrubs, which can attain the density of a maquis. The invertebrate fauna of the sea-lavender sward is richer than that of the lower zones, and particularly noteworthy is the presence, from May and June onwards, of numbers of grasshoppers (Orthoptera).

Reptiles and mammals, rather rare in the preceding zones, find an excellent habitat in the sea-lavender sward. Wall Lizards (*Lacerta muralis*), Green Sand Lizards (*L. viridis*) and the large and impressive Ocellated Lizards (*L. lepida*) abound; and Montpellier and Ladder Snakes (*Malpolon monspessulana* and *Elaphe scalaris*) find their favourite habitat here; but the Grass Snake (*Tropidonotus natrix* = *Natrix natrix*) and the Water Snake (*T. viperinus* = *N. maura*) prefer the vicinity of water, and the Southern Bordeaux Snake (*Coronella girondica*) is only sometimes seen; the skink *Chalcides lineatus* has been recorded in the soil. Before the advent of myxomatosis there was a very dense population of Rabbits in this habitat. The burrows of Foxes and of Badgers are frequently found, and the Weasel (*Mustela nivalis*) is fairly common. Several species of small rodents and insectivores (including the tiny musk shrew, *Suncus etruscus*) are also common. Cattle for bull-fights and semi-wild horses graze here and in the marshes near-by. The upper parts are frequented by large flocks of sheep from September till May.

Most of the birds nesting in the *Salicornietum fruticosae* are also found in the sea-lavender sward. The Red-legged Partridge, Stone Curlew, Lapwing, Skylark and Tawny Pipit are characteris-

tie. The Bee-eater (*Merops apiaster*) hunts here, and also nests if it finds a sandy cliff. Wherever the philaria bushes appear, the Magpies nest, and often also Linnets (*Carduelis cannabina*), Corn Buntings, Nightingales, Whitethroats (*Sylvia communis*) and Great Grey Shrikes (*Lanius excubitor*).

Often, passing over these dry swards, one comes upon groups of tamarisks or even elms. They grow in the places where man-made ditches retain fresh water. Many of these ditches have not been maintained for dozens of years and now look quite natural. If the fresh water is held for only a very limited part of the year, there are only a few more or less stunted tamarisks. If, however, it is retained for a longer period, the tamarisks become more splendid, get covered with brambles, and even are shortly replaced by elms or even white poplars, which may actually form woods round the ditches, where these are supplied with permanent fresh water. These trees shelter a relatively rich avifauna, part of which feeds in the zones already described. The Kestrel and Black Kite make their nests in the elms or poplars, Turtle Doves (*Streptopelia turtur*) more in the brambles. Rollers (*Coracias garrulus*), Hoopoes (*Upupa epops*) and Green Woodpeckers (*Picus viridis*) occupy their hollows. Nightingales and White-throats sing where brambles are present. Penduline Tits (*Remiz pendulinus*) (plate 54) nest in the tamarisks, elms and other trees at the edges of ditches, and Fan-tailed Warblers (*Cisticola juncidis*) favour their vicinity. Cuckoos (*Cuculus canorus*), Scops Owls (*Otus scops*) and Little Owls (*Athene noctua*) are common here, and the Long-eared Owl occurs in some places. Among rarer birds breeding in this zone are the Sardinian Warbler and the Lesser Grey Shrike (*Lanius minor*), and perhaps in some places the Blue Tit (*Parus caeruleus*), while the Kingfisher (*Alcedo atthis*) may breed irregularly. The Short-toed Eagle (*Circaetus gallicus*) is seen all the summer, but no nest has been found so far, and immature Bonelli's Eagles (*Hieraetus fasciatus*) may hunt here all the year round.

Where the woods become rather denser, Cetti's Warblers (*Cettia cetti*), Melodious Warblers (*Hippolais polyglotta*), Great Tits (*Parus major*), Blackcaps (*Sylvia atricapilla*) and Golden Orioles (*Oriolus oriolus*) are to be found. Along old branches of the river this habitat grows in some places into denser woods and is then like the riverain forest. Around farm-houses it often assumes a more park-like aspect and is then colonized by a number of species attached to cultivated land: Barn Owl (*Tyto alba*), Tawny Owl (*Strix aluco*), Carrion Crow, Jackdaw (*Corvus monedula*), Mistle Thrush (*Turdus viscivorus*) (occasionally), Spotted Flycatcher (*Muscicapa striata*), Woodchat Shrike (*Lanius senator*), Starling (*Sturnus vulgaris*), Greenfinch (*Chloris chloris*), Goldfinch, Chaffinch (*Fringilla coelebs*), House Sparrow (*Passer domesticus*) and Tree Sparrow (*P. montanus*). In spring and autumn these woods often show quite spectacular concentrations of central and north European Passerines on migration.

While it is true that the *Arthrocnemum glauci*, *Salicornietum fruticosae*, and sea-lavender sward succeed each other as one goes inland from the brackish lagoons to the cultivated parts, it must not be assumed that all the land of the low *sansouire* zone consists only of *Arthrocnemum glauci*, that this is followed by a uniform belt of *Salicornietum*, and that the whole peripheral part of the Camargue is given over to sea-lavender sward. The Camargue is a large plain, but slopes—often imperceptible to the naked eye—making a difference in height of about 50 cm. between the lowest and highest points in almost every sq km. of the plain are everywhere apparent. As the type of vegetation is, above all, determined by the height of the ground above the saline ground-water table, the flora reacts sensitively to differences of only 10 or 20 cm. We are not, therefore, faced with a succession of vegetation zones pure in themselves, but with a mosaic of the plant associations described in the preceding pages. In every zone of the low *sansouire* and of the upper *sansouire* we find *Arthrocnemum*, *Salicornietum*, and the sea-lavender sward, but in the low *sansouire* it is generally the *Arthrocnemum* that is dominant. In the intermediate zone it is the *Salicornietum fruticosae* that dominates, and in the high part the largest area is covered by the sea-lavender sward. Thus the Pratincole, which has been called a typical bird of the *Salicornia fruticosa* zone, in fact breeds mostly in the *Arthrocnemum glauci*, but always in the intermediate zone, in the neighbourhood of *Salicornia fruticosa* and of fresh water.

The low *sansouire* has undergone modification by indirect human intervention only in the salt-pans; it remains wild for practically its whole extent, man's only influence being in the influx of waste water from the cultivation. On the other hand, the land of the upper *sansouire* is extensively levelled, worked and maintained under irrigated cultivation. The two largest tracts still intact—although a little penetrated by cultivation—are situated one south-east of the Vaccarès round Fielouse and the Tour du Valat, and the other south-west of the Vaccarès round Mornès, Bardouine and Les Grandes Cabanes. Each of these sectors still contains about 40 sq: km. of upper *sansouire* in its wild state.

The numerous depressions in the upper *sansouires* are occupied by marsh of a very weak salinity which supports a freshwater fauna and flora. Their surface area varies between a few ares (are = 100 sq. m.) and some sq. km. Open marshes, with submerged plant masses and with relatively little vegetation emerging, must be distinguished from the marshes with the surface well-nigh invisible beneath a dense growth of reeds and reed mace (*Typha*).

(c) *Open marshes.*

The vegetation of the open marshes forms compact submerged clumps of plants, of which the chief are a water-milfoil, *Myrio-*



*phyllum spicatum*, and a pondweed, *Potamogeton pectinatus*. These plants, like the *Ruppia* of the brackish waters appear at the beginning of the spring, flower in May and fruit in the course of the summer. Their seeds accumulate at the bottom from the end of the summer onwards. On the edge of these marshes, as also in the shallower marshes which dry out entirely, grow bulrushes (*Scirpus*) and water crowfoot (*Ranunculus*). The seeds of the former and the bulbs of the latter are added to the store composed of the seeds already mentioned and the area is thus prepared to receive the wintering ducks. In the flowering season, from March until May, the water crowfoot covers the marsh in white carpets. The invertebrate fauna here is generally rich in species and in individuals. Apart from the planktonic crustaceans (Cladoceres and Copepoda) whose big swarms are often to be seen, especially in winter, there must be noted the presence in spring and summer of numbers of larvae and imagos of various insects (in order of importance: Diptera (flies), Coleoptera (beetles), Heteroptera (bugs), Odonata (dragonflies), Ephemeroptera (mayflies), etc.). The fish fauna—in the marshes submerged all the year round—includes Carp (*Cyprinus carpio*), Rudd (*Scardinius erythrophthalmus*), Catfish (*Ameiurus nebulosus*), Pike Perch (*Lucioperca lucioperca*), etc.—in other words fresh-water species exclusively. Also to be seen are Eels (*Anguilla anguilla*).

Batrachians are also abundant in this zone of fresh-water marsh: Marsh Frogs (*Rana ridibunda*) are everywhere, and Southern Mud Frogs (*Pelobates cultripes*) in some temporary pools.

There are hardly any aquatic mammals, Otters (*Lutra lutra*) being very rare, but herds of bulls and horses like to come, especially in the fine season, to browse in these marshes: as a result they must fertilize them with their dung.

Nesting birds most characteristic of these marshes are Whiskered Terns (*Chlidonias hybrida*) (plate 58 right) and Black-winged Stilts (plate 57 bottom). The terns make their nests between the emergent stalks of bulrushes (*Scirpus*), and these plants provide both material for these floating nests and the anchor that keeps them in place. It has been observed that the terns are incapable of pulling out for themselves the stalks necessary for construction but are reduced to collecting stalks already pulled out by bulls. They nest in groups of from several dozen to several hundred pairs. In these colonies and their neighbourhood Great Crested Grebes (*Podiceps cristatus*) and Little Grebes (*P. ruficollis*), as well as Coots (*Fulica atra*), often place their nests.

The Black-winged Stilts prefer to construct their cone-shaped nests on the edges of small marshes. Mallard, Gadwall, Red-crested Pochard and Garganey (*Anas querquedula*) breed around these marshes and stay there during the summer with their young.

The level of the marshes falls constantly throughout the summer, many of them being completely dried out by the beginning of

autumn, by which time others are surrounded by wide mudflats. On these flats many waders on their autumn migration find a habitat which often holds them for some time. Assemblies of Stilts begin in July and are soon augmented by large bands of Little Ringed Plovers (*Charadrius dubius*) and of Wood Sandpipers (*Tringa glareola*). These two species pass in tens of thousands and, like other Limicolines, undergo at the beginning of autumn in the Camargue a partial moult of their flight feathers. This keeps them in the district for some weeks. Other species of "shanks" arrive, including quite regularly the Marsh Sandpiper (*Tringa stagnatilis*). Snipe are very numerous (especially the Common Snipe, *Capella gallinago*, but also Jack Snipe, *Lymnocyptes minimus*) and often *Calidris* of various species. Ruffs and Ringed Plovers come to join these Limicolines, although they prefer the brackish lagoons. The fish and invertebrate fauna concentrate in the shrunken pools and attract different species of herons: Common Herons which arrive about the end of June, Purple Herons and Little Egrets, as well as Black-headed and Herring Gulls, and even Black Kites and Egyptian Vultures (*Neophron percnopterus*). From July on, flocks of different ducks also make their appearance, and from the middle of autumn it is they which predominate over all other species, remaining alone with flocks of Coots, some Black-headed and Herring Gulls, Great Crested Grebes, Little Grebes, Cormorants and Herons over the winter on the rain-swollen marshes.

In the spring a new migration of Limicolines takes place, but it is not so numerous as that of autumn, as the raised level of the water does not leave any open shores. The Black-tailed Godwits predominate in March and early April, and the Wood Sandpipers at the end of April and in May.

(d) *Marshes under reedbeds.*

The flora of the reedbed marshes is composed mainly of reeds (*Phragmites communis*) and of reed-mace (*Typha angustifolia*), whose young shoots appear from March onwards, and whose flowering takes place at the end of spring and in early summer. The density of vegetation is considerable and dry stalks remain throughout the winter where they are not cut or burned, as is done in some places with the object of making the spring growth more abundant.

The invertebrate fauna of these marshes is principally composed of insects (larvae and imagos). Diptera, Heteroptera and Odonata are the most important groups. Molluscs, although more frequent in these marshes than in those with submerged vegetation, are mostly in small numbers; plankton swarms are generally un-spectacular.

Among fish, only *Gambusia* (*G. affinis* = *holbrocki*) frequent these marshes in any quantities. While, of batrachians, Marsh Frogs are still abundant, it is the Tree Frogs (*Hyla arborea*) that

predominate in this dense vegetation. Some newts (*Triturus helveticus*) and Pond Tortoises (*Emys orbicularis*) also inhabit this zone. The mammals of the reedbeds are still practically unknown, but some Brown Rats (*Rattus norvegicus*) are found, as also occasional Otters and Polecats (*Mustela putorius*).

Among nesting birds the Purple Heron (plate 58) is the most spectacular, breeding in small colonies of 4-100 pairs. At the season of rearing young a constant traffic is established between their nests and the dykes and marshes of the neighbourhood, facilitating the tracing of the colonies. Bitterns (*Botaurus stellaris*) and Little Bitterns (*Ixobrychus miuutus*) are common nesters, as are Little Grebes, Water Rails (*Rallus aquaticus*), Moorhens (*Gallinula chloropus*) and Coots. The status of the small rails of the genus *Porzana* is little known, but it is likely that the Spotted Crake (*P. porzana*), Baillon's Crake (*P. pusilla*) and Little Crake (*P. parva*) breed here and there. Marsh Harriers (*Circus aeruginosus*) are common; Montagu's Harriers (*Circus pygargus*) also nest here, but are less numerous. Among Passerines, Reed Warblers (*Acrocephalus scirpaceus*) and Great Reed Warblers (*A. arundinaceus*) (plate 56 right) nest in large numbers in the reeds, while Bearded Tits (*Panurus biarmicus*), Savi's Warblers (*Locustella luscinioides*) and Reed Buntings (*Emberiza schoeniclus*) occupy the tussocky edge of the reedbeds. Moustached Warblers (*Luscinola melanoptogou*) construct their nests in the reed-mace itself and are common wherever this plant grows in any density.

These reedbeds, which are thus quite rich in the breeding season, are very poor during migration and over the winter. Their food resources are very much restricted: the tiny seeds of the reed and *Typha* are eaten only by some Passerines, notably Reed Buntings and Bearded Tits. No seeds remain in the water as they do in the open marshes, and the resources in invertebrate fauna and fish are also less extensive than in the open marshes and are accessible only to some specialists, notably the different rails which stay there in considerable numbers on passage. In some places around Vaccarès and in the Petite Camargue the reeds form no more than a belt around deeper stretches of open water, and produce "edge effects" which may enrich their fauna, especially in fishes. Among birds, the Great Crested Grebe is added in such places.

#### ECOLOGY OF WINTERING DUCKS

About 150,000 ducks winter in the Camargue, making it one of the principal European wintering places for Anatidae. These are mainly seed-eating, and to a less extent grass-eating, species, for which animal food plays only a secondary rôle. Food resources for these ducks are mainly the following:

- (i) In the brackish lagoons, the beds of *Ruppia*, covering a large number of sq. km. in this zone. The ducks eat their seeds and often also the stems.
- (ii) In the open marshes of the upper *sansouire* zone, the

*Potamogeton* (Pondweed) and *Myriophyllum* (water-milfoil), whose seeds and stems must be eaten by the ducks, as also the *Scirpus* (bulrush) and *Eleocharis* which bear much-sought seeds. The stems of the numerous *Chara* (algae) must probably also be eaten, as well as the bulbs and possibly the stems of *Ranunculus baudotii* (water crowfoot).

- (iii) Finally, the cultivations which, in the rice-fields often left fallow during the winter, offer numerous grains of rice and, in the submerged vineyards, grape-seeds and weed-seeds.

Teal, Mallard and Wigeon are, usually in that order, the most numerous species in winter. They alone make up more than two-thirds of the total number of wintering ducks. Gadwall, Shoveler and Pochard (*Aythya ferina*) follow, with 10,000 or more individuals each, and some thousands of Tufted Duck (*Aythya fuligula*), Red-crested Pochard and Pintail mingle in the bands. All the other ducks come to the Camargue in only small numbers, except the Gargancy of which several thousand pass in spring and autumn without stopping for the winter.

The flocks stay during the day on the lagoons of the Reserve or on the big marshes of some private properties, where they are generally not much disturbed. The Reserve alone holds nearly two-thirds of the duck population of the whole Camargue. In the evening the bands flock in all directions towards the interior of the country, to settle in small marshes or on slightly-flooded or even almost dry cultivated lands. Although most species can be found in nearly all habitats, the Wigeon and the Pintail have a clear preference for the brackish lagoons with *Ruppia* beds, while the Teal keep rather to the *Scirpus* of the edges of the fresh-water marsh; Gadwall often browse in the vegetation in the middle of the big fresh-water swamps, and Pochard, Tufted Duck and Red-crested Pochard prefer the rather deeper parts of slightly brackish or fresh-water pools; Shoveler and Mallard are met with almost everywhere. We cannot go further into the details of the ecology of these wintering ducks, because neither stomach analysis nor systematic observation of the search for food have yet been made in the Camargue.

#### THE CRAU

A few kilometres east of the Grand Rhône a gradual slope forms the zone of transition between the marshes of the Camargue and the stony plains of the Crau. From the bulrush (*Scirpus*) and reed (*Phragmites*) marshes there is a gradual rise by the marshes of sedge (*Cladium*), and the damp grasslands of purple moor-grass (*Molinia*) mingled with quillwort (*Isoetes*) and *Holoschoenus* and by the dry grasslands of tor-grass (*Brachypodium*) to the evergreen oakwood.

From the north of Mas Thibert (16 km. south-east of Arles) to

Fos-sur-Mer (on the Mediterranean 4 km. north-west of Port-de-Bouc) and as far as Miramas (north of the Étang de Berre), the woods of evergreen or holm oaks (*Quercus ilex*), mixed with philaria and with some other evergreen shrubs, form a belt round the southern part of the Crau, whose breadth ranges from a few hundred metres to several kilometres. In places the woods are impoverished and degenerate to a scrub in which the kermes oak (*Quercus coccifera*) and cistus (*Cistus spp.*) replace the evergreen oak.

The fauna of the transition zone has never been studied and can hold some surprises, both for birds and other vertebrates. It is improbable, however, that any birds live there which are not found elsewhere in the Camargue or the Crau. The oakwood itself also remains nearly unknown territory as regards mammals and reptiles, although the Hare (*Lepus europaeus*), Rabbit, Weasel and Ladder Snake have all been observed there. However, some ornithological observations enable a provisional list of its breeding birds to be given:

Red-legged Partridge ( <i>Alectoris rufa</i> )	Nightingale ( <i>Luscinia megarhynchos</i> )
Stone Curlew ( <i>Burhinus oedicnemus</i> )	Orphean Warbler ( <i>Sylvia hortensis</i> )*
Turtle Dove ( <i>Streptopelia turtur</i> )	Sardinian Warbler ( <i>Sylvia</i>
Great Spotted Cuckoo ( <i>Clamator</i>	<i>melanocephala</i> )
<i>glandarius</i> )*	Subalpine Warbler ( <i>Sylvia cantillans</i> )
Nightjar ( <i>Caprimulgus europaeus</i> )—?	Great Grey Shrike ( <i>Lanius excubitor</i> )
Woodlark ( <i>Lullula arborea</i> )*	Lesser Grey Shrike ( <i>Lanius minor</i> )*
Magpie ( <i>Pica pica</i> )	

\*These four species probably occur only where the habitat is changed by cultivation.

Passing through the oak forest we reach the stony plains without woody vegetation, called the Coussous, the genuine Crau (plate 60 upper). Only the virgin regions of its southern, flat part are described here, the north being cultivated or showing some transition to the Alpilles mountains. Today two great tracts of these Coussous still survive, one at the north-western end of the Crau and the other to the south, almost entirely separated from each other by the irrigated cultivation around Entressen. The southern part still covers more than 120 sq. km. (partly developed as airfields), and the northern accounts for about 80 sq. km. The vegetation of this stony plain is very sparse, but rich in species. The asphodel (*Asphodelus fistulosus*) and the grass *Stipa capillata* are the most characteristic plants. Other abundant and generally distributed plants are the flax (*Linum gallicum*), a thyme (*Thymus vulgaris*), several euphorbias (*Euphorbia cyparissias*, *E. exigua* and *E. seguieriana*) and also the grasses *Dactylis glomerata* (cocksfoot), *Brachypodium ramosus* and *Sideritis romana*. The vegetation of the Crau develops with the aid of rains chiefly from winter to spring, and shrivels up rapidly on the arrival of summer. Herds of sheep are pastured there from autumn to spring and their folds are the only features relieving this monotonous landscape.

If the mammals and reptiles of this habitat are still very little known, the avifauna is nevertheless pretty well explored. Here is the list:

Kestrel ( <i>Falco tinnunculus</i> )—at sheepfolds.	Calandra Lark ( <i>Melanocorypha calandra</i> )
Lesser Kestrel ( <i>Falco naumanni</i> )—at sheepfolds.	Short-toed Lark ( <i>Calandrella cinerea</i> )
Red-legged Partridge ( <i>Alectoris rufa</i> )	Skylark ( <i>Alauda arvensis</i> )
Little Bustard ( <i>Otis tetrax</i> )	Crested Lark ( <i>Galerida cristata</i> )—?
Stone Curlew ( <i>Burhinus oediconemus</i> )	Swallow ( <i>Hirundo rustica</i> )—at sheepfolds.
Pratincole ( <i>Glareola pratincola</i> )	Black-eared Wheatear ( <i>Oenanthe hispanica</i> ) (plate 60 lower)
Pin-tailed Sandgrouse ( <i>Pterocles alchata</i> )	Tawny Pipit ( <i>Anthus campestris</i> )
Little Owl ( <i>Athene noctua</i> )—at sheepfolds.	Linnet ( <i>Carduelis cannabina</i> )*
Hoopoe ( <i>Upupa epops</i> )—at sheepfolds.	Corn Bunting ( <i>Emberiza calandra</i> )*

\*These two species probably occur only where the habitat is changed by cultivation.

The Short-toed Lark is by far the most numerous species, being found everywhere and in great density.

There follows the transition zone between the Crau and the Alpilles. Here Dartford Warbler (*Sylvia undata*), Cirl Bunting (*Emberiza cirrus*) and Ortolan Bunting (*E. hortulana*) should be added as breeding birds.

#### THE RIVERAIN FOREST

Along both arms of the Rhône a fairly damp, dense forest has grown up between the embankments and the river. For most of the course it is from 10 to 30 metres wide, but it broadens to a hundred or even several hundred metres at certain places along the Grand Rhône, as at Beaujeu, Giraud, Bécasses, the Bois d'Estaing and the Mas du Village. Tallon (1958) describes the vegetation of this forest in the following terms (translated from the French, with scientific names inserted):

"The riverain forest, or white poplar (*Populus alba*) association, borders the two arms of the river with a tall and dense fringe of pale green, but generally only as far back as the embankment. Besides the white poplar it includes the common elm (*Ulmus campestris*) with, in the lowest part towards the Rhône, the white willow (*Salix alba*), the alder (*Alnus glutinosa*), an ash *Fraxinus oxyphylla* and, in the most elevated parts, some oaks (*Quercus pubescens*). In the shrub-layer are such shrubs as privet (*Ligustrum vulgare*), dogwood (*Cornus sanguinea*) and hawthorn (*Crataegus* spp.). There are few herbaceous plants, as the Rhône often overflows the ground; we cite, as typical, stinking iris (*Iris foetidissima*), a cuckoo pint *Arum italicum*, the grass *Brachypodium silvaticum*, a ragwort *Senecio erraticum*, and rarely in the moistest parts the Loddon lily (*Leucoium aestivum*)."

In recent years an invading shrub *Amorpha fruticosa* has assumed a dominant position in the undergrowth.

Among mammals, which are as yet little known in this forest, the Beaver (*Castor fiber*), still widespread, and the Red Squirrel (*Sciurus vulgaris*) must be specially mentioned. The avifauna is

fairly rich, but, like this habitat as a whole, it shows little Mediterranean character and has affinities to the avifauna of a riverain forest of any other part of Europe. Here are the most abundant and typical species :

Sparrowhawk ( <i>Accipiter nisus</i> )	Magpie ( <i>Pica pica</i> )
Black Kite ( <i>Milvus migrans</i> )	Jay ( <i>Garrulus glandarius</i> )
Hobby ( <i>Falco subbuteo</i> )	Great Tit ( <i>Parus major</i> )
Turtle Dove ( <i>Streptopelia turtur</i> )	Blue Tit ( <i>Parus caeruleus</i> )—?
Cuckoo ( <i>Cuculus canorus</i> )	Long-tailed Tit ( <i>Aegithalos caudatus</i> )
Scops Owl ( <i>Otus scops</i> )	Short-toed Treecreeper ( <i>Certhia brachydactyla</i> )
Tawny Owl ( <i>Strix aluco</i> )—?	Blackbird ( <i>Turdus merula</i> )
Long-eared Owl ( <i>Asio otus</i> )	Nightingale ( <i>Luscinia megarhynchos</i> )
Green Woodpecker ( <i>Picus viridis</i> )	Cetti's Warbler ( <i>Cettia cetti</i> )
Great Spotted Woodpecker ( <i>Dendrocopos major</i> )	Melodious Warbler ( <i>Hippolais polyglotta</i> )
Lesser Spotted Woodpecker ( <i>Dendrocopos minor</i> )	Blackcap ( <i>Sylvia atricapilla</i> )
Golden Oriole ( <i>Oriolus oriolus</i> )	Spotted Flycatcher ( <i>Muscicapa striata</i> )
Carriion Crow ( <i>Corvus corone</i> )	Chaffinch ( <i>Fringilla coelebs</i> )
Jackdaw ( <i>Corvus monedula</i> )	

To this list must be added, as a speciality of the Camargue riverain forest, the colonies of Little Egrets (plate 53 right), Night Herons and Squacco Herons.

#### ECOLOGY OF THE HERONRIES

Four different types of heronries can be distinguished in the Camargue :

(a) Mixed colonies in the riverain forests of the Grand Rhône, mainly of little Egrets with which are associated numerous Night Herons and often some Squacco Herons. Every year about three colonies of this kind exist in the Camargue, each containing from about a hundred to more than a thousand breeding pairs. These colonies shift their sites fairly often, probably on account of the cutting or growth of trees. The herons need a fairly thick wood which lets them build in positions sheltered from the *mistral*, since the wind makes the eggs fall out of the nests when the trees shake.

(b) Colonies in clusters of stone pines, composed similarly to those of the riverain forest, of which there are two or three occupied in the Camargue each year. For such colonies exposure to the wind is less damaging, since the pines are more stable against the *mistral*.

(c) Colonies of Little Egrets or Night Herons, or both, in tamarisks on the edges of the marshes, of which only two have yet been reported, one of about 50 pairs of Night Herons, the other of about 200 pairs of Little Egrets and a few Night Herons.

(d) Colonies of Purple Herons already described on page 339.

The total number of colonial-nesting herons in the Camargue may be estimated at about 1,500 pairs of Little Egrets, more than 11,000 pairs of Purple Herons, over 1,000 pairs of Night Herons

and 10 or 20 pairs of Squacco Herons. In 1957 and 1958 at least one pair of Cattle Egrets (*Ardeola ibis*) bred in a mixed colony.

The fishing-grounds of these herons cover nearly all the Camargue. The following types can be distinguished:

- (i) the lagoons of the low-lying *sansouire*, searched especially by the Little Egrets, but fairly often too by Purple Herons;
- (ii) open swamps of the upper *sansouire*, exploited by all four species;
- (iii) overgrown swamps of the upper *sansouire*, the rather open parts of which are searched by Purple, Night and Squacco Herons;

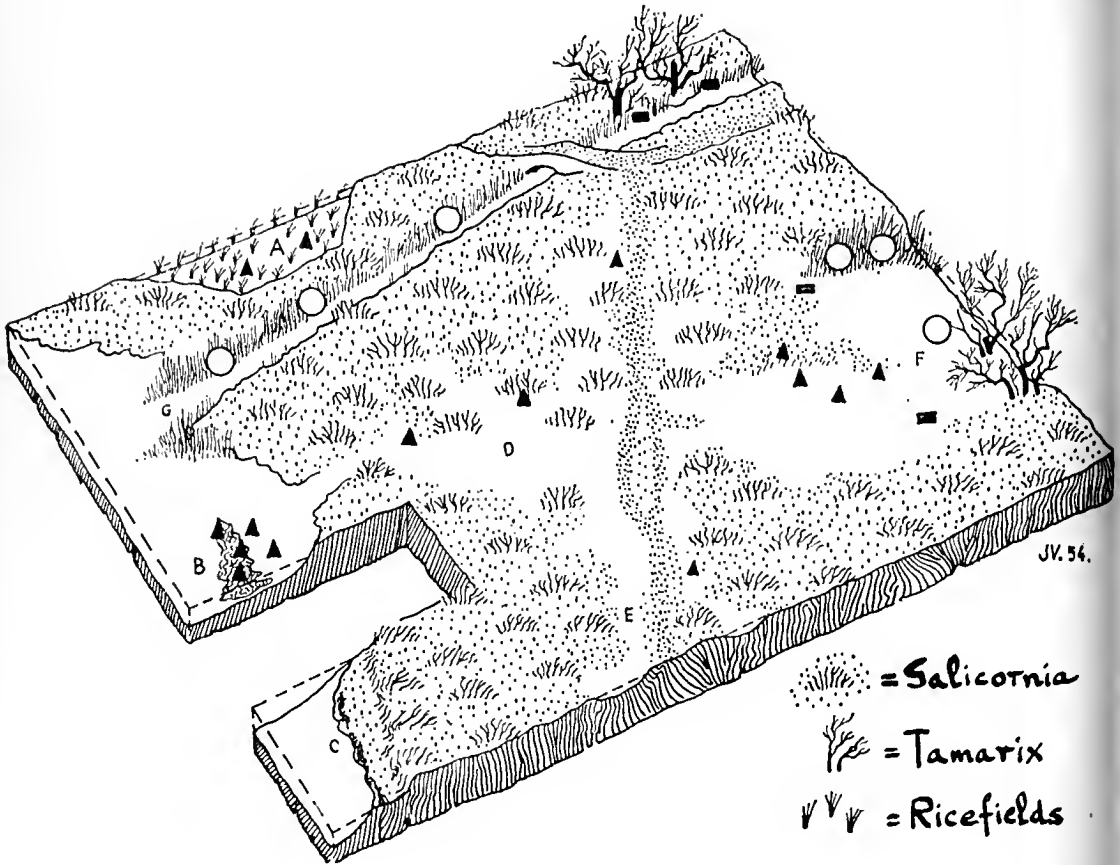

FIG. 3—THE FEEDING GROUNDS OF THE THREE MAIN HERON SPECIES IN THE CAMARGUE  
 LITTLE EGRET (*Egretta garzetta*)—black triangles  
 NIGHT HERON (*Nycticorax nycticorax*)—black rectangles  
 PURPLE HERON (*Ardea purpurea*)—large white circles

The areas of *Salicornia*, tamarisks and ricefields are suggested by symbols in the drawing. The feeding grounds are further indicated by the lettering:

A = Ricefields.

B & C = Pools of high salinity and about 15 cm. deep. (B with *Ruppia* and algae).

D & F = Pools of low salinity, with *Ranunculus* or *Potamogeton* in the centre, and *Salicornia* and *Scirpus* on the edge.

E & G = Ditches (G with *Typha* or *Phragmites*).

(Taken from a drawing by J. A. Valverde in *Alauda*, vol. xxiv, page 7)

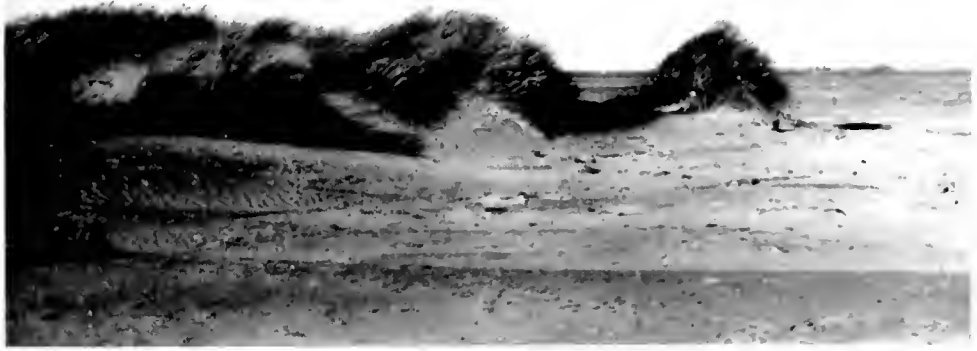

*L. Hoffmann*

## SAND-DUNES AND FLAT SHORE: BEAUDUC, CAMARGUE.

Low, narrow, marram-dominated dunes divide the lagoons from the flat, dry beach and the sea; only Short-toed Larks and Tawny Pipits nest among them, but gulls and terns come to feed on the rich insect fauna (see pages 324-325).

*G. K. Yeates*

## LA DIGUE DE LA MER, NEAR LES SAINTES-MARIES: CAMARGUE, APRIL 1937

Between Les Saintes-Maries and Salin de Giraud (map, vol. 1, pp. 506-507) a road runs like this among the lagoons. In spring the reinforcing posts, like the dunes, provide the first resting-places for many migrants.

*L. Hoffmann*

## CRACKED MUD AND ARTHROCNEMUM IN THE LOWER SANSOÛIRE: CAMARGUE

Flooded in winter and dried out into a jig-saw in summer, this is a characteristic habitat of the lower delta—the haunt of Skylarks, Short-toed Larks, Yellow Wagtails and, in the bare areas, Kentish Plovers (see page 326).



G. K. Yeates

GULL-BILLED TERN BY NEST: ETANG DIT L'IMPÉRIAL, CAMARGUE, MAY 1950. Small islets in the lagoons, if high enough to escape flooding and sufficiently protected from the *mistral*, often harbour large colonies of gulls and terns which are thus out of reach of Foxes (see pages 329-330). Typical of these, though varying in numbers, is the Gull-billed Tern (note the short tail and stout bill).



G. K. Yeates

AVOCETS AT NEST: ETANG DE FANGASSIER, CAMARGUE, MAY 1947. The black-and-white Avocets, with their distinctively upcurved bills, are the characteristic wading birds of the islets, which they share with terns, gulls, some Kentish Plovers, Red-crested Pochard and other ducks, etc. (see pages 327 and 330). The vegetation here is glasswort (*Aythya*). Nests are sometimes much less bulky.



G. K. Yeates

FLAMINGOS WITH NESTS AND YOUNG: NEAR SALIN DE GRAUD, CAMARGUE, MAY 1956

Industrial salt-pans are a feature of the south-eastern Camargue and the Petite Camargue. There in the summer the Flamingos find excellent feeding conditions, and the single colony is formed on an island where there are no other species except the Herring Gulls (see page 330). The choice is fortunate, for the ground, being private, permits control of visitors down the low access routes. Here the newly-hatched chicks are being led to water, and the great variation in the size of the adults can be seen.



*L. Hoffmann*

JUNIPERUS PHOENICEA IN THE BOIS DES RIÈGES: CAMARGUE, APRIL 1949  
 Phoenician junipers are the dominant growth over this old chain of sand-dunes to the south of Vaccarès (see page 329). This area is a virgin landscape of great interest to the botanist, a vestigial counterpart of the rich dunes of the Coto Doñana, but breeding birds are few: Sardinian Warbler, Nightingale, Red-legged Partridge, Magpie, Kestrel.



*G. K. Yeates*

EDGE OF SALINE LAGOON: ÉTANG DE FOURNIET, CAMARGUE, MAY 1950  
 The heart of the Camargue is occupied by the great *étangs*, varying annually in depth and becoming less saline in the north. Most of the breeding birds are confined to suitable islets (see plate 50), but hordes of waders come on migration and in winter during the day there are vast flocks of ducks. Here the shore is covered with glasswort (Spectacled Warblers and Yellow Wagtails) and scattered tamarisks.



G. K. Yeates

LITTLE EGRET AT NEST

Along both arms of the Rhône a narrow belt of damp forest has grown up between the river and the embankments, dense enough to harbour Beavers. It is an association of white poplars, some elms and other trees, with a thick shrub-layer of privet, dogwood, hawthorn, etc. (see pages 342-343). Although not confined to this habitat, the principal colonies of Little Egrets (and Night and Squacco Herons) are here, and also such species as Black Kite, three woodpeckers, Golden Oriole, Short-toed Treecreeper and Melodious and Cetti's Warblers.

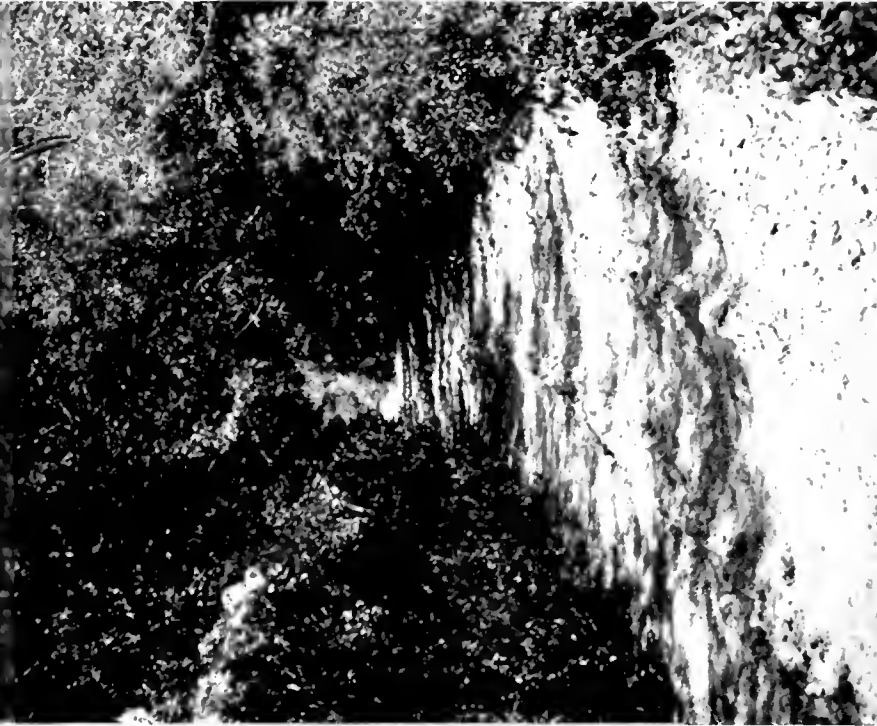

F. Hoffmann

PART OF RIVER FOREST



G. K. Yeates

MALE PENDULINE TIT BUILDING NEST: LA CAPILLIÈRE, CAMARGUE, APRIL 1937. Tamarisks are characteristic of the upper *sansouïre* and of the drains (*canaux*). It is in them (and also in elms and other trees) that one of the Camargue's special birds, the Penduline Tit, most frequently makes its elaborate nest (see page 335). Greyish-white head and throat, black mask and chestnut back make this species easily recognisable. The nest here is only half constructed: the exposed and flimsy sprays of tamarisk to which it is fixed afford little protection against the *mistral* which destroys many first attempts annually.



G. K. Yeates

## UPPER SANSOUIRE NEAR LA CAPELIÈRE: CAMARGUE, APRIL 1937

In the more raised areas the vegetation becomes less sparse and the glasswort (*Arthrocnemum*) is replaced by the bushier *Salicornia fruticosa* (see page 332). This is transitional ground between the saline lagoons and the fresh-water *marais*. Here there are Spectacled Warblers in the glasswort, Fan-tailed Warblers in the grass, Penduline Tits in the trees.



G. K. Yeates

## A TYPICAL CAMARGUE FARM: NEAR VILLENEUVE, MAY 1950

North of Vaccarès reclamation has destroyed the natural habitats. Cultivation round the *mas* (see page 346), with these cypresses for wind-breaks, has produced a pastoral countryside that is little different, except for its many drainage ditches, from other parts of Provence. Some 21 species, especially Passerines, are resulting colonists, however.



G. K. Yeates

GREAT REED WARBLER AT NEST

NEAR VILLENEUVE, CAMARGUE, MAY 1947

The Spectacled is the characteristic warbler of the *Salicornia*, in which this nest is sited (see page 334): at one time badly confused in the Camargue with the Dartford Warbler, it is not unlike a Whitethroat, but smaller, with a pinker breast and a more contrasted white throat; the "spectacles" are not conspicuous except at close quarters. In the fresh-water marshes the Great Reed is numerous (as is the Reed Warbler) (see page 330) and its loud song is to be heard not only in the dense reedbeds, but even in the *Salicornia*.



G. K. Yeates

SPECTACLED WARBLER AT NEST

LA CAPILLÈRE, CAMARGUE, MAY 1937





L. Hoffmann

UPPER SANSOUIRE AT LA TOUR DU VALAT: CAMARGUE, JULY 1947

This shows the upper *sansouire* in its less dense form (cf. plate 55 lower), with *Salicornia fruticosa* dominant and the small black Camargue bulls grazing it.



G. K. Yeates

PRATINCOLE ON EGGS: LES GRANDES CABANES, CAMARGUE, MAY 1947

The few Camargue colonies of Pratincoles favour the above type of terrain, though chiefly in the intermediate zone between *Arthrocnemum* and *Salicornia* (see page 336).



G. K. Yeates

BLACK-WINGED STILTS: LES GRANDES CABANES, CAMARGUE, MAY 1937

Sea-lavenders (*Statice* spp.) are dominant in the higher parts of the upper *sansouire* (see page 334). Rapid summer evaporation occasionally leaves Stilts and other marsh birds breeding, as here (male on nest, female right), in a bone dry area.



G. K. Yeates

WHISKERED TERN AT NEST: ÉTANG DE REDON  
 Whiskered Terns are many, often large, tracts of fresh-water swamps in the upper *sansouire*. These provide nesting haunts for Whiskered Terns, Coots, Great Crested and Little Grebes, and in the dense reed-beds (*Phragmites* and *Typha*) for Purple Herons, Marsh Harriers, Bitterns and Little Bitterns, among others (see pages 337-339). The Whiskered Terns—a contrast of black crown, white cheeks and dusky under-parts—build their floating nests between the emergent stalks of bulrushes (*Scirpus*) and among the water crowfoot (*Ranunculus*), using rush-stalks that have been



L. Hoffmann

FRESH-WATER MARAIS IN THE UPPER SANSOUIRE  
 Between the central saline lagoons and the arms of the water swamp in the depressions in the upper *sansouire*. These provide nesting haunts for Whiskered Terns, Coots, Great Crested and Little Grebes, and in the dense reed-beds (*Phragmites* and *Typha*) for Purple Herons, Marsh Harriers, Bitterns and Little Bitterns, among others (see pages 337-339). The Whiskered Terns—a contrast of black crown, white cheeks and dusky under-parts—build their floating nests between the emergent stalks of bulrushes (*Scirpus*) and among the water crowfoot (*Ranunculus*), using rush-stalks that have been



G. K. Yeates

PURPLE HERON AT NEST: MARAIS DE BARBIGAL, N.E. OF ARLES, MAY 1947. Note the serpentine appearance produced by the long brownish-yellow bill and the even longer thin chestnut neck boldly striped with black. This bird is typical of the marshes in the upper *sansouire*. Though it retires to the thickest and densest reed-beds to build its loose and untidy nests in colonies of 4 or 100 pairs, it is constantly visible passing to and from its feeding-grounds in the dykes and open marshes (see page 330). Its attenuated form is often to be seen as, surprised by the passing car, it rises from a road-side ditch.



*G. K. Yeates*

A BLACK-EARED WHEATEAR SITE: RETOUR DES AIRES, LA CRAU, MAY 1950. As the Rhône brought down silt, the Durance deposited pebbles to form stony deserts. At first sight uninteresting, they make a natural garden of plants like asphodel and thyme. In the pads of the latter, Short-toed Larks nest abundantly; this is the dominant species in an avifauna which includes Calandra Lark, Pratincole (few), Pin-tailed Sandgrouse (rare) and Black-eared Wheatear (see pages 341-342).



*G. K. Yeates*

SMALL BLACK-EARED WHEATEAR (BLACK-THROATED FORM): LA CRAU, MAY 1950. Never common, this beautiful black and sandy bird with white rump and whitish crown is found scattered over the open Crau. Piles of stones erected during the German occupation as an obstacle to aeroplanes appear to have brought about an increase of these birds by providing perches and nest-sites.



FIG. 4—THE FEEDING ZONES OF BLACK-WINGED STILTS (*Himantopus himantopus*), LITTLE EGRETS (*Egretta garzetta*) AND PURPLE HERONS (*Ardea purpurea*) IN A CAMARGUE POOL

These three species are often found feeding at the same pools, but they occupy quite different zones. The Black-winged Stilts, which nest on the surrounding marshy ground, prefer the less deep waters at the edge, where they hunt small insects and their larvae. The Little Egrets penetrate the open water, and the areas of submerged or low vegetation, to a depth of about 15 cm., where they catch insects, crustaceans and fish up to 44 mm. in length. The Purple Herons occupy the deep centre or the reedy edges (*Typha* or *Phragmites*), where they take the biggest fish. There is little or no overlap in the feeding-zones of the three species.

(Taken from a drawing by J. A. Valverde in *Alauda*, vol. xxiv, page 8)

- (iv) ricefields, in which Little Egrets and Squacco Herons often obtain food, and Night and Purple Herons occasionally do so;
- (v) irrigation and drainage channels visited particularly by Purple Herons and frequently also by Night Herons.

While Purple Herons eat mainly fish, the Little Egrets and Night Herons have a varied diet in which insects and crustaceans are generally more important than fish. The Little Egret hunts most often by running in the shallower and more open parts of the swamps, which allows it to catch insects and crustaceans more easily than fishes. The Purple Heron awaits its chance in the deeper parts of the swamps or on the edges of dykes. The Night Heron prefers overgrown places and also relies on ambush.

The feeding-grounds of Little Egret, Night Heron and Purple Heron are illustrated in Fig. 3; and Fig. 4 indicates the different depths at which the Little Egrets and Purple Herons feed, compared with the Black-winged Stilts.

#### INFLUENCE OF CULTIVATION

The northern part of the Camargue and of the Crau, as well as the higher ground following the arms of the river, are today for most of their extent cultivated, and cultivation is more and more infiltrating the lower ground, too. These cultivated areas take the form of isolated *mas* (farm townships) equipped with an irrigation system and generally surrounded by a little woodland, by ricefields, by vineyards, by meadows and by some fields of cereals (plate 55 lower). Their establishment in the Camargue has had a great direct and indirect effect on the bird population.

(a) Species which probably only colonized the Camargue and Crau as a consequence of reclamation for agriculture:

Lesser Kestrel ( <i>Falco naumanni</i> )	Swallow ( <i>Hirundo rustica</i> )
Quail ( <i>Coturnix coturnix</i> )	House Martin ( <i>Delichon urbica</i> )
Woodpigeon ( <i>Columba palumbus</i> )—non-breeding	Carrión Crow ( <i>Corvus corone</i> )
Great Spotted Cuckoo ( <i>Clamator glandarius</i> )	Jackdaw ( <i>Corvus monedula</i> )
Barn Owl ( <i>Tyto alba</i> )	Orphean Warbler ( <i>Sylvia hortensis</i> )
Little Owl ( <i>Athene noctua</i> )	Lesser Grey Shrike ( <i>Lanius minor</i> )
Tawny Owl ( <i>Strix aluco</i> )	Starling ( <i>Sturnus vulgaris</i> )
Swift ( <i>Apus apus</i> )	Greenfinch ( <i>Chloris chloris</i> )
Crested Lark ( <i>Galerida cristata</i> )	Goldfinch ( <i>Carduelis carduelis</i> )
Woodlark ( <i>Lullula arborea</i> )	Serín ( <i>Serinus canarius</i> )
	House Sparrow ( <i>Passer domesticus</i> )
	Tree Sparrow ( <i>Passer montanus</i> )

(b) Ordinary species of the natural Camargue or Crau, able in one way or another (not necessarily for breeding purposes) to take advantage of habitats created by cultivation:

Purple Heron ( <i>Ardea purpurea</i> )	Garganey ( <i>Anas querquedula</i> )
Little Egret ( <i>Egretta garzetta</i> )	Black-tailed Godwit ( <i>Limosa limosa</i> )*
Squacco Heron ( <i>Ardeola ralloides</i> )	Wood Sandpiper ( <i>Tringa glareola</i> )*
Night Heron ( <i>Nycticorax nycticorax</i> )	Black-winged Stilt ( <i>Himantopus himantopus</i> )
Mallard ( <i>Anas platyrhynchos</i> )	Herring Gull ( <i>Larus argentatus</i> )
Teal ( <i>Anas crecca</i> )*	

Black-headed Gull ( <i>Larus ridibundus</i> )	Nightingale ( <i>Luscinia megarhynchos</i> )
Black Tern ( <i>Chlidonias niger</i> )*	Melodious Warbler ( <i>Hippolais</i>
Whiskered Tern ( <i>Chlidonias hybrida</i> )	<i>polyglotta</i> )
Gull-billed Tern ( <i>Gelochelidon nilotica</i> )	Blackcap ( <i>Sylvia atricapilla</i> )
Golden Oriole ( <i>Oriolus oriolus</i> )	Linnet ( <i>Carduelis cannabina</i> )
Magpie ( <i>Pica pica</i> )	Corn Bunting ( <i>Emberiza calandra</i> )
Great Tit ( <i>Parus major</i> )	

\*These four species do not breed on the Camargue, but have a certain importance by reason of their great abundance on passage.

The fact that the species listed can profit from cultivation does not imply that they have increased following agricultural reclamation. Some of them have lost one habitat in order to gain another instead, which may be either better or worse than the previous habitat.

(c) Species whose distribution has been reduced by agricultural reclamation:

Red-legged Partridge ( <i>Alectoris rufa</i> )	Short-toed Lark ( <i>Calandrella cinerea</i> )
Lapwing ( <i>Vanellus vanellus</i> )	Skylark ( <i>Alauda arvensis</i> )
Stone Curlew ( <i>Burhinus oediconemus</i> )	Spectacled Warbler ( <i>Sylvia</i>
Pratincole ( <i>Glareola pratincola</i> )	<i>conspicillata</i> )
Pin-tailed Sandgrouse ( <i>Pterocles</i>	Tawny Pipit ( <i>Anthus campestris</i> )
<i>alchata</i> )	Yellow Wagtail ( <i>Motacilla flava</i> )
Roller ( <i>Coracias garrulus</i> )	Great Grey Shrike ( <i>Lanius excubitor</i> )

This last list of species is briefer than that of the species favoured by the spread of cultivation. While, however, the species so favoured are largely ubiquitous forms existing in many other places, the endangered species are aboriginal forms more characteristic of the wild Camargue and less common elsewhere in Europe.

The Stonechat (*Saxicola torquata*) needs particular mention. This species was common some ten years ago, but has since disappeared almost completely as a breeding bird. The increasing irrigation does not seem to be sufficient explanation for its disappearance.

If agricultural reclamation has profoundly modified the places where it has occurred, it has no less influenced the Camargue as a whole through bringing in so much fresh water. This water, after having irrigated the ricefields, is discharged into the brackish lagoons, raising their summer levels and reducing their salinity. At the same time, it inflates the volume of ground-water, which remains saline. This has led to changes in the flora and the invertebrate fauna, as well as in the avifauna of the saline lagoons. The Avocet, needing wide mudflats flooded with water to a shallow depth, has disappeared from certain places, as has the Flamingo, which now only finds at certain spots the salinity which it requires. Black-headed Gulls and Herring Gulls, however, taking advantage not only of the higher water-level in the saline lagoons but also of the cultivated fields themselves, have increased.

The raising of the ground-water table, on the other hand, has modified the terrestrial vegetation, especially to the detriment of trees. The herbage has also suffered in some places. Lapwings and Stone Curlews have greatly declined in the upper *sansouire*,

and the Pratincole has vanished from places where it used to nest. This last species does not seem to have decreased in the Camargue as a whole, but rather to have colonized new breeding places instead of old ones.

At the moment there is a move to discharge the used irrigation water by pumping it into the Rhône instead of pouring it into the lower-lying lagoons. If this project should be realized it would no doubt trigger off a development in the opposite direction which would tend to turn the still uncultivated parts of the Camargue once more towards the aspect which they had before the area's invasion by rice-fields.

Another danger exists in the extension of the salt-pans, which takes place at the expense of the saline lagoons. The modification of the avifauna which this involves can be appreciated by comparing the fauna of the saline lagoons (pp. 326-328) with that of the *salins* or salt-pans (pp. 328-329). It will above all harm the wintering ducks, but also some of the nesting waders and terns.

The Camargue is thus a landscape undergoing profound transformation, and its protectors have a very heavy responsibility. Will they succeed in conserving its treasures or must we face the successive losses of some of its most interesting species?

#### ACKNOWLEDGEMENTS

My grateful thanks are due to my collaborators, Messrs. L. Bigot, P. Agucsse and R. Lévêque, who have contributed, each according to his speciality, various notes and faunal lists which have served me as a basis for a great part of this work; to Mr. G. Tallon for having revised and criticized the botanical sections; to Mr. G. K. Yeates for providing many of the photographs and for preparing the captions to them all; to Mr. E. M. Nicholson for having translated this paper into English; and to him and Mr. I. J. Ferguson-Lees for having suggested in the first place that this ecological sketch should be written, for having given me their careful criticisms, and for having had the patience to wait for several months for the task's completion.

#### SELECTED BIBLIOGRAPHY

Since the last century the Camargue has attracted many naturalists and the publications on the area are exceedingly numerous. The files of the Biological Station at the Tour du Valat, which are far from being complete, contain more than 700 titles on the fauna, flora and geography of the Camargue, and more than half of these concern ornithological publications.

Here we can do no more than draw attention to a small selection of the most important modern works in each field:

#### (1) GEOGRAPHY AND GEOLOGY

- OLDHAM, E. D. (1930): "Historic changes of level in the delta of the Rhône". *Quart. J. Geol. Soc. London*, 86: 64-93.  
 DENIZOT, G. (1938): "La Crau, la Camargue et l'Étang de Berre". (Part I.) *Ann. Fac. Sc. Marseille*, (2), 11: 1-60.  
 RUSSELL, R. J. (1942): "Geomorphology of the Rhône delta". *Ann. Ass. Amer. Geogr.*, 32: 149-254.



DUBOUL-RAZAVET, CHR. (1955): "Contribution à l'étude géologique et sédimentologique du delta du Rhône". *Thèse, Fac. des Sciences, Paris—Rec. Trav. Station Marine d'Endoume, Bull. no. 10, 363 p.*

## (2) BOTANY

MOLINIER, R. and TALLON, G. (1949-50): "La végétation de la Crau (Basse-Provence)". *Rev. Gén. Bot.*, 56: 525-540; 57: 48-61, 97-127, 177-192, 235-251, 300-318.

TALLON, G. (1958): "La végétation de Camargue; groupement plus particuliers au delta". *83e Congrès National des Sociétés Savantes, Colloque sur la Camargue.* (in press).

————— (1929-1957): Numerous notes in *Actes Rés. Zool. Bot. de Camargue* (until 1941) and *La Terre et la Vie* (since 1949).

## (3) INVERTEBRATE ZOOLOGY

PETIT, G. and SCHACTHER, D. (1954): "La Camargue. Etude écologique et faunistique". *Ann. Biol.*, 30: 193-253.

AGUESSE, P. (1955): "Notes préliminaires sur les Odonates de Camargue". *La Terre et la Vie*, 1955: 287-308.

RIOUX, J. A. and ARNOLD, M. (1955): "Les Culicidés de Camargue". *La Terre et la Vie*, 1955: 244-285.

BIGOT, L. (1955): "Les Rhopalocères et Grypocères de Camargue". *La Terre et la Vie*, 1955: 309-312.

ENGEL, H. (1957): "Ökologisch-faunistische Studien im Rhône-Delta, unter besonderer Berücksichtigung der Mollusken". *Bonn. Zool. Beitr.*, 8: 5-55.

AGUESSE, P. (1957): "Complément à l'inventaire de la faune invertébrée des eaux camarguaises". *La Terre et la Vie*, 1957: 241-252.

BIGOT, L. (1957): "Complément à l'inventaire de la faune entomologique de la Camargue". *La Terre et la Vie*, 1957: 253-258.

AGUESSE, P. (1957): "La classification de eaux poikilohalines, sa difficulté en Camargue, nouvelle tentative de classification". *Vie et Milieu*, viii: 341-365.

BIGOT, L. (1958): "Les grands caractères écologiques des milieux terrestres de Camargue". *83e Congr. Nat. Soc. Sav., Colloque sur la Camargue* (in press).

## (4) ICHTHYOLOGY

LÉVEQUE, R. (1957): "Notes sur la faune ichthyologique de Camargue". *La Terre et la Vie*, 1957: 237-240.

## (5) ORNITHOLOGY

## (a) Illustrated books:

YEATES, G. K. (1946): *Bird Life in Two Deltas*. London.

GALLET, E. (1949): *Les Flamants roses de Camargue*. Lausanne.

YEATES, G. K. (1950): *Flamingo City*. London.

DRECHSLER, H. (1957): *Wunderwelt der wilden Vögel*. Leipzig.

————— (1957): *Zigeuner, Stiere und Flamingos*. Leipzig.

## (b) Faunistic and ecological works:

GLEGG, W. E. (1931): "The birds of L'Île de la Camargue et la Petite Camargue". *Ibis*, 13, I: 209-241, 419-446.

MAYAUD, N. (1938): "L'avifaune de la Camargue et des grands étangs voisins de Berre et de Thau". *Oiseau*, viii: 284-349. (This work takes into consideration all the previous literature.)

LOMONT, H. (1938-1954): Numerous ornithological notes in *Actes Rés. Zool. Bot. de Camargue* (Nos. 22/23, 1938-39), *Bull. Mus. Hist. Nat. Marseille* (3-6, 1943-46) and *La Terre et la Vie* (1949-54).

VALVERDE, J. A. (1955/56): "Essai sur l'Aigrette Garzette (*Egretta garzetta*) en France". *Alauda*, xxiii: 145-171, 254-279; xxiv: 1-36.

HOFFMANN, L. and PENOT, J. (1955): "Premier recensement des canards hivernant en Camargue". *La Terre et la Vie*, 1955: 315-20.

LÉVEQUE, R. (1957): "L'avifaune nidificatrice des eaux saumâtres camarguaises en 1956. Essai de recensement suivi d'une première esquisse écologique". *La Terre et la Vie*, 1957: 150-178.

HOFFMANN, L. and LÉVEQUE, R. (1955-57): "Calendriers ornithologiques" in the 1st, 2nd and 3rd *Comptes rendus* of the Station Biologique de la Tour du Valat.

[Dr. Hoffmann's "An ecological sketch of the Camargue" completes the international trilogy begun last December with "The Camargue and the Coto Doñana" by E. M. Nicholson, I. J. Ferguson-Lees and P. A. D. Hollom (*antea*, vol. L, pp. 497-519) and continued in January with "An ecological sketch of the Coto Doñana" by J. A. Valverde (*antea*, pp. 1-23). We regret the delay over the publication of this third paper, but to make the comparison fully comprehensive Dr. Hoffmann and his collaborators had to undertake some further investigations during the 1958 breeding-season, and we considered it well worth while to accept the postponement thereby involved.

As Dr. Hoffmann's paper is one of a series of important and inter-related studies from the Station Biologique de la Tour du Valat and from the research scientists associated with the Réserve Zoologique et Botanique de Camargue, the scientific names have not been changed to conform to British practice except in the cases of birds, where it would be confusing in an ornithological journal to depart from those normally adopted. In any event the divergences were very small and, where the names of animals and plants differ from those used in Sr. Valverde's paper, synonyms have been indicated.

At the beginning of this series we stated that a list of sources of information would be published at the end of it. Dr. Hoffmann has pointed out at the end of his paper that the library of the Station Biologique de La Tour du Valat, although incomplete and still rapidly growing, already contains more than 700 Camargue titles, and his select list of the most important works for further reference is an invaluable guide. Meanwhile, we feel that the publication in April 1958 of Guy Mountfort's *Portrait of a Wilderness* (see review, *antea*, pp. 200-202) has obviated the necessity of our publishing a bibliography on the Coto Doñana, as this up-to-date work on the area contains a list of over 50 titles.

With the completion of the series, arrangements are being made by our publishers for the preparation of a limited number of reprints for the convenience of those specially interested. These will be available in mid-November from H. F. & G. Witherby, Ltd., 5, Warwick Court, London, W.C.1, at a cost of 2/6 for each of the three papers or 6/- for the whole series. The reprints will include the 36 plates of photographs with which the series has been illustrated.

Although the three papers together represent perhaps the most comprehensive international comparative study yet undertaken in the animal ecology of Europe, the authors are well aware of its many limitations and are themselves intensifying efforts to widen and deepen available knowledge, in which they hope that others will be stimulated to participate by the provisional and preliminary outlines now given. Further ecological investigations are much needed elsewhere, not least in the British Isles.—EDS.]

# MIGRANT LAND-BIRDS IN THE WESTERN APPROACHES

By IVOR McLEAN AND KENNETH WILLIAMSON

DURING THE FIRST THREE WEEKS of April 1957, and again during the last three weeks of October, the first-named author served with the scientific staff of "Weather Observer", a weather-ship of the Marine Branch, Meteorological Office (Air Ministry), at station "Kilo" in latitude  $45^{\circ}$ N. and longitude  $16^{\circ}$ W. This is well within the Atlantic region named Western Approaches by Nicholson (1951), and is distant some 500 miles from Land's End and 600 miles west of the Biscay coast of France, the nearest land being the north-west corner of Spain 300 miles away. A number of land-bird migrants were recorded, especially in the autumn, when, out of 8 which came aboard, 5 died of starvation following exhaustion of their energy reserves. This short paper is chiefly devoted to these land-birds, but a few comments on marine species seen in spring are included first.

## SPRING MIGRATION

There were no Fulmars (*Fulmarus glacialis*) at "Kilo" in April. The last was seen at  $51^{\circ}$ N. on the way down, and the first was at about  $50^{\circ}$ N. on the return. Kittiwakes (*Rissa tridactyla*) were very scarce and mostly immature: "Kilo" must be near their southern limit at this season. All 4 species of skua were seen, a Great (*Catharacta skua*) at  $49^{\circ}55'$ N. on 27th March being followed by a Pomarine (*Stercorarius pomarinus*) at  $45^{\circ}$ N.  $16^{\circ}$ W. on 2nd April. The first Arctic Skua (*S. parasiticus*) appeared at "Kilo" on 11th April, and the one and only Long-tailed Skua (*S. longicaudus*) came next day.

A Swallow (*Hirundo rustica*) and a Sand Martin (*Riparia riparia*) arrived at "Kilo" together, at 19.32 hours G.M.T. on 5th April. The weather was cloudy, with a layer of low stratus at 1,000 feet and visibility about 2 miles. They were still aboard at dusk, but at first light on the 6th only the Swallow remained. During the morning it frequented the bridge and often flew into the wheelhouse, where it was seen to take at least two house-flies; but there were not enough flies aboard to make a meal, and it died in mid-afternoon. The *Daily Weather Report* for this period suggests an origin for these two birds on the north coast of Spain or the Biscay coast of France.

The ship returned to base on 23rd-24th April, and a steady trickle of migrants was seen as it passed through the Irish Sea. A Swallow at 05.40 hours on the 24th, circling the ship, was probably one which had come aboard on the previous evening and gone to roost on a ledge of the balloon-shed roof. It flew off 10 minutes later in a northerly direction. In mid-morning 2 Swallows passed, flying northwards, and 3 flew low in the same direction in mid-afternoon. There were 2 Dunlins (*Calidris alpina*) at mid-day and a Wheatear (*Oenanthe oenanthe*) in the afternoon, and 7

Meadow Pipits (*Anthus pratensis*) at various times between 09.00 and 13.28 hours, all flying low towards the north and showing no interest in the ship. The weather was very hazy and at no time was the Irish coast visible; the ship passed within 10 miles of Great Saltee (Co. Wexford) in the early morning, but the only land seen was Tuskar Rock, just visible about 2 miles away. These birds would appear to have been migrating normally, in stable anticyclonic air.

#### AUTUMN MIGRATION

A greater variety of land-birds was seen at "Kilo" during the last three weeks of October than had appeared in the spring, and the species are best dealt with in systematic order:

MOORHEN (*Gallinula chloropus*).—An immature bird arrived aboard soon after noon on 9th October. Once, when disturbed, it settled on the sea alongside the ship. Late in the day it hid in a tunnel-like cavity beneath the bridge, and died there during the night.

REDSTART (*Phoenicurus phoenicurus*).—A ♀ appeared at 09.45 hours on 10th October and stayed about an hour.

ROBIN (*Erithacus rubecula*).—A Robin came aboard at 11.25 hours on 14th October and stayed half-an-hour.

MEADOW PIPIT (*Anthus pratensis*).—One which came aboard during the night of 8th/9th October died in the early afternoon. Of 2 which flew aboard at noon on the 9th, one died in the night and the other late next morning. All were of quite good weight, nearly 20 gm. A Meadow Pipit appeared in the early afternoon of the 12th and stayed half-an-hour.

YELLOW WAGTAIL (*Motacilla flava*).—One took refuge on the ship at 18.00 hours on 13th October. It was not so exhausted as the pipits and spent most of the daylight hours searching for food. Next morning it was less active and permitted close approach, preferring to run along the deck rather than fly when disturbed—always a sign of growing weakness. Its weight was 14 gm. Early in the afternoon it was disturbed by one of the crew and fell into the sea and was drowned. The bird had a buffish eye-stripe, white chin, and buffish-white under-parts tinged with yellow, and was probably a ♀.

GREY WAGTAIL (*Motacilla cinerea*).—One which came aboard at 09.10 hours on 17th October stayed under an hour and a half. Like the Redstart and Robin, it was very restless and easily disturbed.

STARLING (*Sturnus vulgaris*).—At 09.00 hours on the 15th a tanker, the *Lingula*, passed very close, southward-bound, and a bird which rose from her deck when disturbed by one of the crew, to fly round the ship and settle again, was recognized as a Starling.

The times at which the Moorhen, Meadow Pipits and Yellow Wagtail appeared suggest that these were diurnal migrants; the Redstart and Grey Wagtail, on the other hand, would appear to have been migrating by night.

The Moorhen and Meadow Pipits of 9th October could have originated on the north and west coasts of the Iberian Peninsula, where there was fog early in the day and a light E.S.E. to S.E. wind on the periphery of a low centred to the south-west of "Kilo". Similar conditions obtained on the morning of the 10th, as the low was slow-moving and in process of filling. Early on the 12th there was a light E.N.E. wind over Biscay associated with a front lying between "Kilo" and Finistère, south of an anticyclone over England. There was fog on the Finistère and Biscay coasts, and indeed over most of France, early on 13th and 14th October, with a light E.N.E. breeze offshore to the north of a weak low in the Straits of Gibraltar. The Grey Wagtail seems likely to have originated on the south Spanish or Portuguese coasts and to have travelled through a col between highs over the Azores and Pyrenees, behind the warm front of a low then advancing on southern Ireland.

During the ship's return through the Irish Sea on 2nd November, some Skylark (*Alauda arvensis*) migration was seen. A flock of 10 circled the ship at 11.20 hours before making off towards Wicklow Head, clearly visible 10 miles abeam. At 12.30 hours 2 lots, of 56 and 47 birds respectively, crossed the bows: they were flying low towards Ireland, which was still clearly visible. The ship was abeam of the *Codling* Light-vessel at the time.

#### REFERENCE

NICHOLSON, E. M. (1951): "Birds of the North Atlantic". *Proc. Xth Int. Orn. Congr.*, 600-602.

## OBITUARY

WILLIAM STANLEY COWIN (1907-1958)

HIS MANY FRIENDS and correspondents throughout the United Kingdom will learn with regret of the sudden death of W. S. (Will) Cowin, of Douglas, Isle of Man, on 29th June 1958, at the nearly age of fifty.

Born in Douglas on 17th August 1907, Will Cowin was a man of many parts: a keen rifleman, chess-player and philatelist, but probably best known as the Island's foremost naturalist, equally interested and well-informed in botany, entomology and ornithology. He had numerous plant and insect discoveries to his credit, notably that of *Epitriptus cowini*, a robber-fly (Asilidae) which bears his name. But birds were his chief love, and throughout his life he was an indefatigable watcher and collator of information which he passed on annually to his fellow-naturalists through the medium of *The Peregrine* (*Yn Shirragh ny Ree*), the Manx natural history magazine which he founded in 1942 (in collaboration with Kenneth Williamson) and which he edited for sixteen years. When, in 1948, the British Trust for Ornithology

launched its scheme of Regional Representatives, it was only natural that Will Cowin should be invited to stand for the Isle of Man, and this position he retained until his death. Ringing was a particular interest of his and in the past thirty years he was responsible for marking several thousand birds, particularly Ravens, Choughs and gulls. He made a number of contributions to *British Birds* and other journals and at the time of his death he was engaged in writing a revision of P. G. Ralfe's *The Birds of the Isle of Man*, which it is hoped will be published in the near future.

A very gentle and kindly man, he would spare no pains to show hospitality to the many British and foreign naturalists who visited the Island, and he had a wide circle of correspondents who will surely mourn his untimely death.

E.F.L.

## NOTES

**Little Shearwater in Cheshire.**—On 10th May 1958 a living bird was picked up by school-children in a field near Stoekport, Cheshire, and eventually came into the hands of one of us (C.G.B.) from Inspector Brooks of the R.S.P.C.A. The bird was not visibly injured and was free from oil, but was nevertheless moribund. Upon superficial inspection it was clearly seen to be a shearwater with a passing resemblance to a Manx Shearwater (*Procellaria puffinus*), being generally dark above and white below. However, it was markedly smaller than a bird of that species and had a more slender and more delicately formed bill, which was also noticeably shorter in proportion to the head. Moreover, the dark crown did not extend below the eye as it does in the Manx Shearwater, but left a whitish irregular superciliary stripe.

We examined the bird carefully while it was still alive and the following measurements and description were recorded:—

Bill 26 mm., wing 178 mm., tarsus 36 mm., middle toe with claw 40 mm. The crown, back and tail were sooty black, paler and more smoky on the head, and darker and browner on the back. The line of demarcation between dark and light on the head and neck was indistinct and irregular with a narrow zone of mottling. The under-parts were generally white, and the white on the lores extended over the eye. A narrow mottled stripe on the ear-coverts separated the superciliary stripe from the white cheek. The under tail-coverts were generally white, but the hindmost feathers were sooty black forming a narrow irregular terminal border to the underside of the tail. This terminal border was very narrow at the sides. The dorsal aspect of the wings was sooty black but noticeably more brown than was the back; some greater wing-coverts had narrow white tips. The under wing-coverts were white but the small feathers at the leading edge were mottled. The upper mandible was black. The lower mandible was black at the tip but otherwise blue-grey. The tarsi were blue-grey save for their hinder aspect which was black. The inner and middle toes were blue-grey and the outer toes were black. The webs of the feet were a very pale bluish lilac. The iris was brown-black.

There seemed little doubt from comparison with the descriptions in *The Handbook*, and with the photograph facing page 211 in R. M. Loekley's *Shearwaters* (1942), that the bird was a Little Shearwater (*Procellaria baroli*) and in all probability

of the Madeiran race (*P. b. baroli*). There had been a fairly strong wind from the south-west for two days.

The bird subsequently died and the skin is now preserved in Bolton Museum (Lancashire). Mr. A. Hazelwood and Mr. E. Gorton of that museum confirmed our identification of it as *P. b. baroli* and reported to us that it was a female very much in moult with a granular ovary; it was in good bodily condition, but it had been fatally damaged by a blow leading to peritoneal inflammation.

Mallophaga found on the wing-feathers were identified by Miss Theresa Clay at the British Museum (Natural History) as *Halipeurus* sp. Acarine parasites on the wings proved to be *Pteronyssus puffini* (Buckholz).

This appears to be the twelfth recorded occurrence of the Little Shearwater in the British Isles, and the tenth of the Madeiran race. It is interesting to note that only three of the previous eleven records have been for the spring months of April and May; the other eight, from Kent and Sussex, were reported from August to December.

C. G. BENNETT, A. W. BOYD and N. W. CUSA

**Great Tit killing and carrying Goldcrest.**—On 20th January 1958, Mr. W. French and I were walking near the River Irthing just above Lanercost, near Brampton, Cumberland. It was a very bitter day. As we followed a low drystone wall on the edge of a wood, a Great Tit (*Parus major*) fluttered along the ground and flew up into an elderberry bush some 5-6 feet high. Something appeared to be attached to the bird's feet and at first we thought it was some foreign material entangled in the claws. When we approached, the tit flew very heavily into the next bush, after which it was flushed in turn from quite a number of bushes and sometimes flew distances of 12-15 yards. Eventually it tired and settled on the ground inside the wood, whereupon it started to peck at the object it had been carrying with it. We watched the scene for a few minutes; then my companion crept up against the wall and succeeded in frightening the bird so that it dropped the object—which we had by then concluded must be a mouse. Imagine our surprise on picking up a Goldcrest (*Regulus regulus*), which was still warm. It had been killed by a peck at the back of the skull, the eyes had been eaten and the head was badly torn. What particularly amazed us both, however, was the manner in which the tit carried the Goldcrest in its feet, as would a hawk.

J. L. CARIS

[We showed this remarkable observation to Dr. David Lack, but he was unable to produce any parallel from the studies of Great Tits carried out by the Edward Grey Institute, Oxford. The second observer has sent us an independent letter of confirmation, and the careful and detailed description seems to exclude any possibility of an error. Great Tits have been known to kill "a bat and young birds, attacking the brain" (*The Handbook*, vol. I, p. 248) and will sometimes also attack other birds caught with them in cage-traps.—EDS.]

**Thrush Nightingale and probable Nightingale at Fair Isle, and the problem of identification.**—At least two, and probably three, birds of the genus *Luscinia* were seen at Fair Isle in the course of May 1958. One of these was trapped, and proved to be a Thrush Nightingale (*L. luscinia*), the fourth British record and the third for Fair Isle. Another was well seen, and was almost certainly a Common Nightingale (*L. megarhynchos*). The third must remain indeterminate.

The supposed Nightingale was found by P.H.J. in cultivated land near the Haa, during the early afternoon of 7th May. Notes made at the time gave the following description:

Size, slightly larger than a House Sparrow (*Passer domesticus*) near-by; upper-parts and wings warm brown, upper tail-coverts and tail rufous-brown; breast and belly uniform pale grey-buff, with slightly whiter throat; under tail-coverts appeared to have a pale orange-brown wash. There was the appearance of a faint buff-white ring around the eye. The legs were a medium shade of buffish-grey.

The bird was feeding in the fashion of a Robin (*Erithacus rubecula*), with short jerky movements, mainly along the base of a stone dyke bordering the ploughland, and was watched for ten minutes in good light, at ranges down to ten yards. It then flew away and was not located again.

What was presumably the same bird was seen briefly by James Stout of Midway on his croft on the morning of 8th May, but could not be found later. Neither P.H.J. nor J.S. had had previous experience of the Nightingale, though both had seen the Thrush Nightingale trapped in May 1957 (*antea*, p. 198), and both considered the present bird to be more warmly coloured on the upper-parts. In view of this opinion, and since no striations had been visible on the breast, we were prepared to accept this record as the second occurrence of *L. megarhynchos* at Fair Isle. Our experience with a Thrush Nightingale, a week later, made us more cautious.

The 1958 Thrush Nightingale was caught in the Double Dyke trap at 06.20 G.M.T. on 15th May, the 47th anniversary of the first accepted British specimen at Fair Isle. It was identified from wing-formula (short 1st primary, 3.5 mm. less than coverts; long 2nd primary, 4 mm. less than 3rd; only the 3rd emarginate) and the following description was noted:

Upper-parts and wings earth-brown, considerably less rufous than tail and upper tail-coverts; belly whitish, under tail-coverts buff; a "gorget" of grey-brown wash across the breast and extending on to the flanks, but only very indistinct striations on the breast, considerably less obvious than in our 1957 bird. The outer greater coverts had the small pale tips of a first-summer bird; the inner secondaries were abraded, and showed no pale tips. The legs were brown-flesh in colour. The measurements taken included: wing (straight) 89.5 mm., tail 65, bill (from skull) 16, tarsus 26.5; and the weight was 19.7 gm.

While this bird was still at the observatory, James Stout had flushed a similar bird from the low cliffs at Kirkigeo in the south of the isle. His view was again very brief, and he was justifiably cautious about the identification.



The trapped bird was released at North Haven, and remained near the observatory buildings (usually under them!) until the 17th. On several occasions the writers, with Dr. A. G. G. Thompson and Mr. William Crawford, had fairly good opportunities for observations in the field, when our bird emerged to forage on the sward. It was rarely possible to detect any striations on the breast, and, in bright sunlight particularly, the upper-parts seemed of a much warmer brown than we had anticipated. In other circumstances, we might easily have mistaken the bird for a common Nightingale.

A few days later, through the good offices of Dr. A. C. Stephen and Kenneth Williamson, we received three skins of *L. luscinia* (two Russian, one Polish) and six of *L. megarhynchos* from the Royal Scottish Museum. These confirmed the recognized differences in plumage, *megarhynchos* being redder on the entire upper-parts, with the rump nearer to the rufous tail in shade, whereas in *luscinia* the rump has the more earthy tone of the mantle. The central tail-feathers are rather darker than the rest in *luscinia*, but more or less uniform in *megarhynchos*. Both species have a grey zone across the breast, but in *luscinia* this is darker, and most feathers have deeper grey-brown markings along the shafts. We were very interested to note, however, that in one Russian specimen the striations were very indistinct, and the whole appearance of the breast less clouded, than in the other two specimens. Moreover, the upper-parts were a little warmer in tone. This was very like our 1958 capture.

Our conclusion is that sight-records of Nightingales, especially outside the normal range, should be treated with reserve. A record of the wing-formula of any trapped specimen is imperative. The Thrush Nightingale has considerably extended its range in Sweden during the past few years, as reported in *Vår Fågelvärld* (vol. 17, p. 159) by I. Ahlen, and like some other expanding species—e.g. Greenish Warbler (*Phylloscopus trochiloides*)—may be expected to occur more frequently in Britain.

PETER DAVIS and PETER HOPE JONES

**Nestling Goldfinch's decomposed body rotting feet off rest of brood.**—On 23rd June 1958, in the grounds of Durleigh Reservoir, Somerset, I inspected the nest of a Goldfinch (*Carduelis carduelis*) sited 4ft. 6ins. from the ground in a small buddleia bush. The nest contained three partly fledged young about 8-9 days old, which I decided to ring. To my surprise I was unable to lift any single chick from the nest as their legs appeared to be tangled in something. Eventually I lifted the three out altogether, bringing with them the partially decomposed remains of another nestling which had died when about 4-5 days old. It was this that was causing the trouble, for the live birds each had a leg caught underneath the carcass. One chick I was able to release and ring unharmed, but the other two each had a foot rotted off

completely: in one case the stump had hardened and dried off, but in the other it was still raw and inflamed. If I had not released them it seems extremely doubtful whether they would ever have left the nest safely, which they did within a few days.

EILEEN M. PALMER

**North American birds staying on board ship during Atlantic crossing.**—Among the passengers aboard the Holland-America Line ship "Statendam", which left New York City on 27th September 1957 and arrived in Southampton on 4th October 1957, were two White-throated Sparrows (*Zonotrichia albicollis*), one Black-throated Green Warbler (*Dendroica virens*), one Pine Warbler (*D. pinus*) and one Tennessee Warbler (*Vermivora peregrina*). The two White-throated Sparrows were fed with crumbs by passengers and stewards, and were seen to be alive and apparently healthy on the day when the ship came into sight of the British Isles. The insectivorous warblers were observed to hawk after small flies during the first three days of passage, but were then seen no more: it is conceivable that a faster ship, such as one of the "Queens" or the "United States", would have allowed these birds to arrive safely also. R. MACARTHUR and P. KLOPPER

## REVIEWS

CURIOUS NATURALISTS. By N. TINBERGEN. (*Country Life*, London, 1958). 280 pages; illustrated. 35s.

IN HIS PREFACE, Dr. Tinbergen writes that he long hesitated about writing this semi-autobiographical book, and repeatedly in the main text he seems to find it necessary to defend the pursuit of such "useless" knowledge against the practical commonsense of the average layman, and to justify his devotion to field natural history before his more laboratory-minded professional colleagues. He need not have been either hesitant or defensive. His book is one of the best possible advertisements for the general interest and scientific value of natural history in the proper sense of the term, and should secure many valuable recruits to its pursuit.

Dr. Tinbergen (like Konrad Lorenz and A. R. Wallace, and indeed Charles Darwin himself) is a natural naturalist. He loves nature in all its beauty and strangeness, and wants to understand its manifestations. In this book he describes the various projects which this combination of devotion and interest has led him to undertake, usually in collaboration with a team of students and colleagues. These include a study of how predatory wasps recognize their prey and learn the surroundings of their nest; the amazing memory-capacity of sandwasps; the biological value of camouflage, warning coloration and "terrifying" patterns like eye-spots; the study, largely carried out by his colleague Manning, on the allæsthetic relations between flowers and their insect

pollinators; the extraordinary courtship of the Grayling butterfly; the dispersal habits of Camberwell Beauty caterpillars; a voyage to Greenland to investigate the behaviour of Snow Buntings and Husky Dogs (and incidentally to learn a great deal about the Arctic and its ecology); the ontogeny of behaviour in Hobbies; and finally the elaborate and still incomplete studies of reproductive behaviour in Eiders and in various gulls. For some reason (perhaps because the work was all done in the laboratory), he regrettably does not include an account of his important researches on Stickleback reproductive behaviour.

It is, of course, his ornithological studies which will be chiefly interesting to readers of *British Birds*; but they will find that these are illuminated by his work on insect behaviour and adaptations. In addition, it is very helpful to his professional colleagues in other branches of biology to have his general conclusions set forth so clearly, without over-abundance of detail and technical argument.

Not unnaturally, what I personally find of chief interest is the flood of new light that he and Lorenz have shed on bird courtship and display. When, at the start of my biological career over 45 years ago, I began studying and puzzling over these problems in grebes and divers and various waders, all I had to go on was the Darwinian assumption that all displays were epigamic, and that the bright colours and striking attitudes involved in them had originated because of their capacity to stimulate the opposite sex. I introduced the idea of mutual selection, and paved the way for the concept of the pair-bond by suggesting that mutual display served as an emotional bond between members of a mated pair in species where both sexes played similar rôles in caring for the eggs and young. By the 1930's it had become clear that a large proportion of displays subserved threat against rivals, not stimulus to mates. Then Lorenz and Tinbergen, largely on the basis of comparative field-study of related species, showed that display attitudes originated from intention movements, displacement activities and other expressions of conflict, and later became genetically ritualized, and enhanced in effectiveness, by the development of appropriate bright coloration and special plumage. In so doing, they made the evolution and function of display much more intelligible (we can now really understand what the Great Crested Grebe's courtship is all about, instead of just speculating as to its Darwinian selective value). They also initiated comparative ethology as a new branch of biological science: one which the field naturalist and bird-watcher can understand and to which they can make useful contributions.

Tinbergen is also one of the chief exponents of taking experimental methods into the field. His work with dummies and models has led to the concept of specific sign-stimuli (e.g. the importance of the red breast in the Robin, as later demonstrated by Lack) and of supernormal stimuli (e.g. with outsize models of eggs). He has also well brought out the great range of

individual variation in display behaviour. Here too, as with simple field experimentation, the amateur can make a real contribution.

I have only one point of general criticism to make. Tinbergen calls the head-flagging posture of Black-headed Gulls "*nothing but* (my italics) the outcome of the simultaneous arousal of fear and a tendency to stay", and the upright posture of Herring Gulls "*nothing but* a combination of movements belonging to two different actions—attack and escape". My experience is that whenever anyone says that something is "*nothing but*" something else, he is almost always wrong! This is the error of reductionism, which tries to explain the present nature of something wholly in terms of its origins or components.

It is of the greatest interest to discover that such attitudes result from the simultaneous arousal of conflicting trends; but they are not "*nothing but*" bits of the two sets of activities, any more than the properties of water are nothing but a combination of the properties of hydrogen and oxygen. The combination is something in its own right, with certain properties which cannot be wholly foretold by a knowledge of the properties of its components. It is a novel entity, which can exert a novel allaesthetic effect, and so become a new sign-stimulus in its own right.

But this is a detail. In general, Tinbergen's book can be warmly commended to all naturalists (which includes, I hope, all readers of *British Birds*).

JULIAN HUXLEY

L'ART FRANCAIS DANS LE LIVRE D'OISEAUX (Eléments d'une iconographie ornithologique française). By RENÉ RONSIL. (*Mémoires de la Société Ornithologique de France et de l'Union Française*, No. 6, Paris, 1957). 136 pages; 20 plates, of which 4 in colour; 4 text illustrations.

THIS, a work of bibliography rather than of ornithology, is an account of French bird-book illustration from the invention of printing to the present day, from the first crude fourteenth century beginnings, through the gradual rise in competence, to the start of the great age in François-Nicolas Martinet's illustrations to Buffon's *Histoire Naturelle des Oiseaux*, and from the age of Levaillant, Vieillot and Temminck to Audubon (who is claimed as a Frenchman) and the lesser known figures of later times. It is unfortunately obvious that the statement of William Swainson quoted on the title-page, "France has always excelled in ornithological painters", applies to the past, that the great age was the beginning of the nineteenth century, that the great French ornithological artists have been primarily museum illustrators and that later French bird-painters have not kept up with the modern trend of portraying birds in action. In spite of the excellence of the illustrations chosen by M. Ronsil, they are few and it is difficult for the ornithologist who is not also a bibliophile to judge of the text without knowing the works (some

of them very rare) with which it deals. However, it is salutary for the British bird-watcher, who all too commonly utterly neglects this branch of his subject, to be informed about the founders of ornithology, the great men of the past, who to him are simply "somebodies" after whom a stint or a skua may have been named. It is salutary also for us to be reminded that it is our duty to preserve the fine bird books of the nineteenth century, the finest that have ever, or probably will ever, be produced, lest they be dismembered to decorate the studies of the rich and provide table-mats for their dinner parties.

M.F.M.M.

## RECENT REPORTS AND NEWS

By I. J. FERGUSON-LEES and KENNETH WILLIAMSON

The items here are largely unchecked reports, and must not be regarded as authenticated records. They are selected, on the present writers' judgment alone, from sources generally found to be reliable. Observers' names are usually omitted for reasons of space and in case a report is subsequently rejected, and none of the items will be mentioned in our annual Index. Readers are asked to submit anything of interest as quickly as possible.

### THE EARLY SEPTEMBER DRIFT

As this summary is being completed we are receiving many reports of a spectacular drift movement in the first part of September. This appears to have affected, to a greater or lesser extent, the whole of the East Coast from Shetland to Essex, and to have been reflected in the south from Kent to the Scilly Isles. Very large numbers of Willow Warblers (*Phylloscopus trochilus*), Redstarts (*Phoenicurus phoenicurus*), Pied Flycatchers (*Muscicapa hypoleuca*), Wheatears (*Oenanthe oenanthe*) and Whinchats (*Saxicola rubetra*), with lesser quantities of Tree Pipits (*Anthus trivialis*), Spotted Flycatchers (*M. striata*) and Garden (*Sylvia borin*) and other warblers, formed the bulk of this movement. But Wrynecks (*Jynx torquilla*) were unusually widespread and a good sprinkling of Barred Warblers (*Sylvia nisoria*), Bluethroats (*Cyanosylvia svecica*), Ortolans (*Emberiza hortulana*) and Red-breasted Flycatchers (*Muscicapa parva*) added considerable spice. Among rarer species, there were at least 14 Icterine Warblers (*Hippolais icterina*)—10 of them being trapped and ringed—in Yorkshire, Norfolk and Dorset. However, as reports concerning this movement are still pouring in, we feel it is best largely to exclude the period from this summary, which therefore chiefly covers August, with, as usual, a few earlier reports received too late for inclusion last month (*antea*, pp. 314-320).

### THE RARER BIRDS IN AUGUST

A few early August rarities were reported last month (*antea*, pp. 318): the Purple Heron (*Ardea purpurea*) at Tring, Hertfordshire, was last definitely seen on 12th August, possibly on the 15th. On the 3rd a *Hippolais* warbler was watched at Portland Bird Observatory, Dorset: this was believed to be a Melodious Warbler (*H. polyglotta*), and birds confirmed as such were trapped there

on 17th and 28th August. These latter dates were paralleled by other reports of Melodious Warblers at Skokholm, Pembrokeshire (young bird, trapped, 15th and 16th); near Eastbourne, Sussex (trapped, 17th); and at Bardsey, Caernarvonshire ("probables" seen, 18th and 29th). Yet all this is somewhat overshadowed by the fact that we have already received news of 12 further Melodious Warblers between 5th and 21st September from Bardsey, Skokholm, Great Saltee (Co. Wexford) and St. Agnes (Scilly Isles). It is interesting to consider how systematic trapping at these bird observatories in recent years has shown this species to be an annual drift vagrant to the western side of Britain, when before 1954 there were only 7 British records!

Another rarer warbler of which there were several reports during August was the Aquatic Warbler (*Acrocephalus paludicola*): the first was at Farlington Marshes, Hampshire, on the 6th, then on the 20th there was one at Holme, Norfolk, and another at Holywell Ponds, Northumberland (the latter being seen again on the 21st); finally, two were seen at Yalding, Kent, on 31st. Juvenile Woodchat Shrikes (*Lanius senator*) appeared on Skokholm on 3rd-4th and 29th-30th, and both were trapped; incidentally, a first-summer female was caught there on 4th June, but has not previously appeared in these pages (*cf. antea*, pp. 280-281 where, however, 2 on Great Saltee were incorrectly dated and should have been given as 3rd and 6th May).

On 4th August an Iceland Gull (*Larus glaucoides*) was identified in Langstone Harbour, Portsmouth, Hampshire, and on the 6th an adult Crane (*Megalornis grus*) was watched for some time near Lothbeg Point, Helmsdale, Sutherland—both species that have figured a number of times in our summaries this year. On the 6th, too, a first-summer Great Spotted Cuckoo (*Clamator glandarius*) was picked up dead at Winterton, Norfolk: there are only 7 previous records of this species in the British Isles.

Ospreys (*Pandion haliaëtus*), perhaps the same bird, were seen in three places in Suffolk in mid-August: at Minsmere, over the River Alde (10th and 11th), and in the Blythburgh area (from 14th to at least 30th). Little Bitterns (*Ixobrychus minutus*) were reported from Yalding in Kent on the 10th and from Cley in Norfolk on the 28th; in addition, the male in Somerset that was first noted on 21st June (*antea*, p. 320) was seen up to 15th August and towards the end of July it was discovered that a female was present in the same area: this latter bird was last located on 22nd August.

On the 14th a Tawny Pipit (*Anthus campestris*) was seen at Ridham Marsh, Kent, and there was an adult at Portland on the 30th. On the 15th a male Roek Bunting (*Emberiza cia*) was identified at Dale Fort, Pembrokeshire, and it was heard again the following day. Another rare bunting was a male Rustic (*E. rustica*) reported from Cannock reservoir, Staffordshire, on the 17th, and on the 18th Portland produced an immature male Black-cared Wheatear (*Oenanthe hispanica*). Then on the 19th, after some hours of N.E./E. wind, no less than 5 Icterine Warblers

appeared at Gibraltar Point, Lincolnshire, and two were trapped: the only other migrants there that day were Pied Flycatchers, six Snipe (*Capella gallinago*) and a Wood Sandpiper (*Tringa glareola*)!

Ireland came into the picture at about this time, with an adult Sabine's Gull (*Xema sabini*) at Kinnegar, Co. Down, on the 20th, and a Short-toed Lark (*Calandrella cinerea*), apparently a juvenile, at Dunerue Street Marsh, Co. Antrim, on the 22nd and the 23rd. About this period an Icterine Warbler arrived on Fair Isle (see below). A few days earlier, on the 17th, an adult Mediterranean Black-headed Gull (*Larus melanocephalus*) appeared at Hartlepool, Co. Durham, for the third year running (*cf. antea*, p. 207) and it was seen regularly thereafter. Essex now also produced an adult Mediterranean Gull at the Naze on the 25th, and another was seen at Copeland Bird Observatory, Co. Down, on the 30th or the 31st; in addition to which there was an immature at Kinnegar on 6th September. A Spotted Crake (*Porzana porzana*) was identified at West Kirby, Cheshire, on the 28th.

A Lesser Yellowlegs (*Tringa flavipes*) that appeared on the Kingsbridge estuary, S. Devon, on 29th August was seen again on 2nd September. It is perhaps possible that this was the same bird as that noted on the Exe estuary on 10th August (*antea*, p. 318), for at least to the second week of September the autumn was notable for the absence of records of American species: by then we had not received one well-authenticated report of a Pectoral Sandpiper (*Calidris melanotos*), a species that in recent years has come to be regarded as a regular wanderer to the British Isles.

The month closed with reports of a White-winged Black Tern (*Chlidonias leucopterus*) at Blythburgh, Suffolk, on the 30th; a Black-winged Stilt (*Himantopus himantopus*) at Thornham, Norfolk, on the 31st; and a male Black-headed Bunting (*Emberiza melanocephala*) at St. Agnes Bird Observatory in the Scilly Isles for five days from the 31st. We do not at the moment, however, reconsider that the description of the tern is sufficient to rule out the possibility of Whiskered Tern (*Ch. hybrida*); and, to a lesser extent, the same problems of escape from captivity apply to the Black-headed Bunting as to the Red-headed species (*E. bruniceps*) (see references given *antea*, p. 320).

#### AUGUST AT FAIR ISLE

With the exception of movements of waders, terns and other sea-birds (see below), migration seems to have been generally sparse throughout most of the country until about the fourth week of August. In such conditions the pattern of migration is usually not very clear on the mainland and it is convenient on this occasion to outline the month on Fair Isle, since the observations there illustrate the general trends and serve as a hook on which to hang the whole picture.

Migration began slowly at Fair Isle, but the latter half of the month was marked by some interesting movements, chief among which were an unusually heavy passage of Common Gulls (*Larus canus*); a remarkably late movement of Swifts (*Apus apus*); and

a pleasant if not over-exciting run of warblers and other species from about the 20th onwards, which provided a curiously accurate foretaste of the big September drift to come.

Early on, there were a few species which are of unusual occurrence at Fair Isle in the late summer, such as a second-year Glaucous Gull (*Larus hyperboreus*) on the 2nd and an adult Whooper Swan (*Cygnus cygnus*) on the sea off North Haven between the 3rd and 6th. Two Shovelers (*Spatula clypeata*) arrived on the 15th, followed by single birds on the 19th and 21st, and there was a Shelduck (*Tadorna tadorna*) on the 22nd. Wader passage was normal except that Green Sandpipers (*Tringa ochropus*) were of almost daily occurrence till the 24th, and Redshanks (*T. totanus*) were more in evidence than usual.

Although Common Gulls moved through daily, with about 160 on the 10th and more next day, the maxima of over 1,000 birds recorded on the 16th and 19th were exceptionally high. These figures were not surpassed later in the month, but numbers again rose to 750 on the 21st and 800 on the 23rd during the period of strong Passerine movement. There was also strong Curlew (*Numenius arquata*) and Snipe (*Capella gallinago*) passage from the 21st. The Swifts, too, were first noted at this time, there being 150 on the 21st with only a single bird over the next two days, and then further bursts of passage with 120 on the 24th and 26th followed by a gradual decrease to the 29th (see "A wreck of Swifts?", below).

The big days for Passerine migrants were the 21st and 24th; although some of the species had appeared by mid-month, their peaks came on one or other of these days. Garden Warblers declined from 10 on the 21st-22nd, but Willow Warblers were most numerous on the 24th-25th. Whinchats, building up slowly from the 19th, reached a peak with 25 on the same two days, whilst Pied Flycatchers were at their best on the 23rd-24th. Of the rarer warblers, there was an Icterine during the 23rd-25th, two Wood Warblers (*Phylloscopus sibilatrix*) on the 19th and one or two later, and Barred Warblers on four occasions—the 9th, 16th, 23rd-24th and 27th-29th. Other interesting species at this period were two Turtle Doves (*Streptopelia turtur*) from the 27th, a Wryneck on the 22nd, an adult male Fieldfare (*Turdus pilaris*) on the 29th-30th, occasional Red-backed Shrikes, an adult male Red-headed Bunting on the 28th, a juvenile Ortolan and three small incursions of Ruffs (*Philomachus pugnax*). Perhaps the most remarkable arrival, however, was of 13 Tree Sparrows (*Passer montanus*) on the 23rd, in view of the strong spring migration of this species (*antea*, p. 283) and the subsequent "summering" on the island of at least two, and possibly as many as 4, birds.

#### PASSERINES AND OTHER LAND-BIRDS

As now happens every year, there was a trickle of Hoopoes (*Upupa epops*) in England from late July and some thirty were reported to us. Until the middle of August (with the exception of one that was present in the Ridgewell area, N. Essex, for much



of July) all were in South Coast counties from St. Agnes in the Scilly Isles to Hampshire, but in the second half of the month single birds were noted at Syston, Leicester (13th-21st); Burley-in-Wharfedale, Yorkshire (16th-17th); Higher Disley, near Stockport, Cheshire (20th); Cheam, Surrey (23rd); Harborne, Birmingham (24th) and Salthouse, Norfolk (30th)—with others in Essex, Kent, Sussex, Dorset and the Channel Islands, and at the beginning of September one appeared at Knocktopher, Co. Kilkenny.

Though the first movements of warblers and chats started at the end of July on both sides of the country (*antea*, p. 317), the trickle remained very thin almost everywhere until 11th-12th and 15th-16th August. At these times there was an increased passage of Willow Warblers and Whitethroats (*Sylvia communis*) in the Irish Sea area, and a movement of Whinchats, Garden Warblers, Sedge Warblers (*Acrocephalus schoenobaenus*) and Whitethroats at various points down the East Coast from Shetland to Norfolk; in some places Redstarts and Pied and Spotted Flycatchers were commented upon. A Long-eared Owl (*Asio otus*), new to the island group, was found in one of the houses on St. Kilda on 10th August, and a Nightingale (*Luscinia megarhynchos*), rare as far north as Yorkshire, was trapped at Spurn Bird Observatory on the 16th. Marsh Harriers (*Circus aeruginosus*) are seldom seen far inland outside East Anglia, so that an immature at Tring, Hertfordshire, on the 17th is also worthy of note.

At Portland Bird Observatory, Dorset, the usual passage of Tree Pipits and Yellow Wagtails (*Motacilla flava*) began in earnest about the 17th and continued to the end of the month, with up to 50+ Tree Pipits a day during the last week and a peak of 300+ Yellow Wagtails on the 30th. The highest number of Yellow Wagtails at Dungeness, Kent, was 120 on the 24th, but the dates of the Portland Tree Pipit movements coincide well with the much smaller passage of this species there and in other southern localities from Kent to Somerset. The first two Tree Pipits of the autumn at Dungeness appeared on the 17th and there were also two at Sandwich Bay, Kent, on the 15th, both places having small numbers of these birds to the end of the month. Similarly, a movement of Tree Pipits was particularly commented on at Kewstoke, north of Weston-super-Mare, Somerset, during the early mornings of the 17th-20th. On the East Coast Passerine movement was poor at this time, except perhaps on the 19th-20th when there was a slightly increased flow of warblers, chats and flycatchers on the N. Norfolk coast, and it was on the latter of these two days that Aquatic Warblers appeared there and in Northumberland (see above).

It was not, in fact, until the period 21st-24th that there came many really large Passerine movements and it will be noted how these and other dates coincide reasonably closely with the peak periods on Fair Isle (see above). On 21st August there was an "avalanche" of Willow Warblers at Skokholm and it was estimated that there were probably over 1,000 on the island: 215 were ringed on that day, together with 30 Whitethroats and 14

Spotted Flycatchers. Dungeness at this time (23rd) had its peak numbers of Whitethroats and Willow Warblers (estimated 250 and 200 respectively)—as well as a Collared Dove (*Streptopelia decaocto*)—and a Whitethroat trapped at Sandwich Bay on the 27th has been ringed at Lundy, Devon, six day previously.

#### A WRECK OF SWIFTS?

On the 23rd, too, Monks' House Bird Observatory, Northumberland, had a small movement of Garden Warblers, Pied Flycatchers and Whinehats, while a Reed Warbler (*Acrocephalus scirpaceus*) was trapped, and on the following day a Barred Warbler was caught (*cf.* Fair Isle). But the main feature of this time here was an interesting "wreck" of Swifts. About 20 were seen in the observatory area from 12.00 to 18.00 on the 22nd, and on that day there were several comments in the district about "late Swifts". The following afternoon 4 were picked up dead or dying on the Farne Islands and subsequently two more were brought in at the observatory. Presumably these birds were connected with the remarkably late passage of Swifts at Fair Isle (see above) and the movement seems to have been reflected as far west as St. Kilda, where 7 appeared on the 23rd and there were 15 on the 24th; there were also 8 there on the 28th, fewer on the next two days and 9 on the 31st. We feel that this passage of Swifts may prove to have been of considerable interest and we should be glad to receive any records of unusual movements, particularly in the north of the country, during the last week of August. On 7th September 100+ Swifts were noted at Spurn, Yorkshire.

Apart from the Swifts there was little of interest on St. Kilda during August, though a Buzzard (*Buteo buteo*) on the 25th was a new bird for the island-group and a Ruff on the 24th and 25th was also noteworthy, this species being rare in N.W. Scotland. There was a strong passage of Ringed Plovers (*Charadrius hiaticula*) there on 20th August, and it is interesting to compare the dates of White Wagtail (*Motacilla alba*) passage with those for, say, Skokholm. The first White Wagtail at St. Kilda was on 19th August, a week later than in 1957, and there had been an increase to 21 by the 21st; on Skokholm the passage of *alba* wagtails began on the 25th with 3, followed by 12 (including one adult male White Wagtail) on the 29th and about 20 (all identified as White Wagtails) on the 30th. An early Lapland Bunting (*Calcarius lapponicus*) and a fine Greenland Wheatear (*Oe. oe. leucorrhoea*) were trapped at Skokholm during this time, both on the 28th.

The last few days of the month were fairly quiet in most places until the 30th-31st when Spotted and Pied Flycatchers reached a peak at Dungeness, and other places reported increases in these species and in Willow Warblers, Redstarts and Tree Pipits. These and Barred Warblers trapped at Gibraltar Point, Lincolnshire, and Blakeney Point, Norfolk, on the 30th and the 31st, were the advance guard of the big September movement.

## WADERS AND SEA-BIRDS

The outstanding feature of the wader passage during the period under review was the movements of Whimbrel (*Numenius phaeopus*), which seem to have been unusually large and widespread ever since the beginning of July (*antea*, p. 316): data are not complete enough for it to be possible to form a full picture of the pattern of this migration, but 9th-10th, 14th-17th and 25th-27th August appear to have been peak periods and the heavy passage was still continuing in the first week of September. Apart from this there has been nothing remarkable about the waders. Some areas, particularly on the South Coast, have reported good numbers of Ruffs, Wood Sandpipers and Green Sandpipers (*Tringa ochropus*), and also of Spotted Redshanks (*T. erythropus*) and Greenshanks (*T. nebularia*), but the general impression is that these species and the Little Stint (*C. minuta*), which is likewise sometimes the subject of big movements, have shown no more than a normal passage—while Curlew Sandpipers (*C. testacea*) have everywhere been astonishingly few.

Only three Temminck's Stints (*C. temminckii*) were reported during August—two at Nene Mouth, Lincolnshire (14th and 26th) and one at Farlington, Hampshire (29th and until 6th September). An early Jack Snipe (*Lymnocyptes minimus*) was noted at Dorney (Common, Buckinghamshire, on 21st August. Apart from these, an Avocet (*Recurvirostra avosetta*) at Steart Point, Somerset, on the 17th and 5 Dotterel at the Midrips, near Camber, Sussex, on the 20th (then 2 there on the 21st) should be mentioned. On 5th August there was an albino Sanderling (*Crocethia alba*) in a flock of 100 of this species at Holkham, Norfolk.

Black Terns (*Chlidonias niger*) were noted in one district or another on almost every day in August, but in the first half of the month reports were few and numbers small except on the 10th, when there was evidently a medium passage in S.E. England, with 55 and 27 at Queen Mary and Staines reservoirs in Middlesex the largest parties recorded. Then from the 16th to the end of the month there was a continuous flow of Black Terns which, however, never reached widespread spectacular proportions. Peaks were on the 18th (including 116 at Westward Ho! in N. Devon and a steady passage off the S.E. Coast), the 24th-25th (highest numbers at Dungeness), the 27th (including 150 at Queen Mary reservoir) and the 30th. (Of these dates the 10th, 24th and 30th are week-ends, but the figures generally and our sources of information suggest no particular bias.) Various reports of the movements of other terns (*Sterna* spp.) have been received, but the data are inadequate.

In previous summaries (e.g. *antea*, p. 317) we included reports of Little Gulls (*Larus minutus*), but, as usual, these became much too frequent for individual mention after the beginning of August ((August-March being the period when this species is a regular visitor). In fact, sixteen counties (including 4 inland ones) reported Little Gulls during August, in some cases two or three

individuals being involved. Among these, however, were several reports from Ireland which are worth itemizing as the species is normally regarded as an unusual visitor there: an adult at Kinnegar, Co. Down, on 16th, 19th and 20th, and an immature there on the last two of these days; an adult by the West Pier at Dun Laoghaire, Co. Dublin, on 22nd August and for two or three days previously; and an immature at Duncrue Street Marsh, Co. Antrim, on 1st September. (Earlier in the summer between 25th May and 29th June, one and sometimes two immatures were seen at Kinnegar.)

A fresh north-east wind on 25th August brought several big parties of skuas, probably all Arctic (*Stercorarius parasiticus*), to the mouth of the River Nene on the south-west side of the Wash: the largest flock was of 40 birds and others were of 31, 26 and 19. It was possible to say definitely that they were not the same birds each time and such a series of large compact groups close inshore seems unusual. It has, in fact, been a good autumn generally for skuas, and there have been a number of reports of Pomarine (*S. pomarinus*) and Long-tailed (*S. Longicaudus*) which we hope to summarize with the September observations.

There have been previous references in *British Birds* to the occurrence of Balearic Shearwaters (*Procellaria puffinus mauretanicus*) off Portland Bill, Dorset (*antea*, vol. xlvii, pp. 285-296; vol. li, pp. 27-28). The first to be seen there this autumn was on 17th August, an average date. On the other hand, at St. Ives Head, Cornwall, where regular sea-watches have been kept each morning, a single *mauretanicus* was identified on 26th July, and between 30th July and 4th August several (maximum 8+ on 31st July) were noted among some hundreds of Manx Shearwaters (*P. p. puffinus*) that were circling in the Bay because sprat were plentiful. Further observations of *mauretanicus* were made at St. Ives on 6th, 13th, 14th, 17th and 20th August, and then there was a very heavy passage (200 estimated) of this race between 06.30 and 07.15 on the 25th; the last, like most of the others, were moving west. Meanwhile, we have received an independent report from the same area of 82 shearwaters moving west in 4½ hours on 15th August: "there were some typical Balearics and a few *P. p. puffinus*, but 57 of the 82 were the contrasted brown and white birds which have been referred to as the 'yelkouan-type'" (*cf. antea*, p. 28). A Sooty Shearwater (*P. grisea*), also flying west, was seen off St. Ives Head on 27th August (and a Great Northern Diver, *Gavia immer*, still in summer plumage, appeared on 31st August and was still present on 9th September).

Though Whooper Swans are not unknown in Ireland in summer (*Birds of Ireland*, 1954, p. 96, gives seven such records, including one for August), the occurrence of 2 adults at Lough Beg, Co. Derry, on 23rd August seems noteworthy. And 4th August is surely an unusually early date for a juvenile Puffin (*Fratercula arctica*) to be found 30 miles inland at Great Gonerby, near Grantham, Lincolnshire.

PURCHASED  
17.8.1958

## SMALL ADVERTISEMENTS

9/- for 3 lines (Minimum); 3/- for each extra line or part thereof. For the use of a Box Number there is an extra charge of 1/-.

9 x 40 Wrayvu Binocular £18/18/0, exchanges, repairs, lists. Bass & Bligh, 18, Market Arcade, Leeds 1.

WANTED—Copies of *British Birds*, MAY, JULY and AUGUST 1957. The Publishers will still pay full price and postage for any in good condition.

GOING TO SPAIN? If so, your pleasure will be doubled by reading Guy Mountfort's *Portrait of a Wilderness*, superbly illustrated by Eric Hosking. It is the outstanding nature book of the year. Recommended by the Book Society. Hutchinson, 30s.

FAIR ISLE BIRD OBSERVATORY. Watchers very welcome in "rare bird season", October-November. Details from Warden.

FOR SALE. *British Birds*, 1931-1940 inclusive; bound green and gold. What offers? Bonus, Green Shutters, Runfold, Farnham, Surrey.

BANNERMAN'S *Birds of Tropical West Africa*, vols. I to VIII for sale, good condition. Apply W. H. Ramsay, Ach-na-Coile, Maybole.

**SPEND YOUR HOLIDAYS IN A BIRD WATCHERS' PARADISE**

### PLACE MANOR

Nestling in the lush Sub-Tropical vegetation of St. Anthony-in-Roseland, on the edge of lovely Percuil Creek, with its own five safe sandy Bathing Beaches. This peaceful spot the outside world has never known; is a haven of rest for countless numbers of our birds.

Open all the year round. Ideal for a Winter Holiday: **THERE IS NO REAL WINTER IN ROSELAND.**

Terms from £5 5s. per week, all found. Write for Illustrated Brochure to O. Harte, Place Manor, St. Anthony-in-Roseland, Portscatho, Truro. Phone Portscatho 256. Enclose medium-sized stamped addressed envelope.

**ON THE GLORIOUS  
CORNISH COAST**

WANTED. Custodian (part time) for small Nature Sanctuary North Essex coast. No qualifications necessary, but must have keen interest in natural history (general or specific) and some knowledge of small craft and outboards. Free cottage. No remuneration. Write Box Z.R.848, Deacons Advertising, 36 Leadenhall Street, E.C.3.

FOR SALE. *British Birds*, vols. 42 (1949) and 43 (1950), unbound, in excellent condition. £2 10s. od. or nearest offer. Smith, 7 Knights Lane, Tiddington, Stratford-on-Avon.

BINOCULARS AND TELESCOPES. New and used. Descriptive lists and expert advice on request. Exchanges, overhauls. J. R. Hebditch, F.B.O.A., F.S.M.C., 44 Hallgate, Doncaster.

BINOCULARS AND TELESCOPES, new and reconditioned, at reasonable prices. Approval allowed, also part exchanges. Lists from Hatton Optical Co. Ltd., Lansdowne, Bournemouth, Hants. (Established 1930).

BINOCULARS AND TELESCOPES, repaired, cleaned and adjusted; send your instrument for estimate by return. Hatton Optical Co. Ltd., Lansdowne, Bournemouth, Hants.

Now available

## NOMINA AVIUM EUROPAEARUM

BY HARRIET I. JØRGENSEN

This useful reference book lists each of 579 European birds under its scientific name, and then gives it in all the main European languages.

300 pages

29/6 post free from

**H. F. & G. Witherby, Ltd.,  
5, Warwick Court, W.C.1.**

Now to be published in late November

**WITHERBY'S  
SOUND-GUIDE  
TO  
BRITISH BIRDS**

by

**MYLES NORTH and ERIC SIMMS**

**Introduced by JAMES FISHER**

*PRODUCED WITH THE CO-OPERATION OF THE  
BRITISH BROADCASTING CORPORATION*

**195 species on 13 double sided 10''  
gramophone records**

- RECORDINGS BY LUDWIG KOCH, ERIC SIMMS, RADIOTJÄNST, JOHN KIRBY, CARL WEISMANN, MYLES NORTH AND OTHERS.
- To be published simultaneously in two parts, each boxed and with descriptive book. £5 10s. 0d. each part (postage 3/- extra).

*PART ONE (Seven records): The Larger Birds  
Non-Passerines  
114 Species*

*PART TWO (Six records): The Smaller Birds  
Passerines  
81 Species*

**Please write for prospectus to the publishers :**

**H. F. & G. WITHERBY LTD.,  
5 Warwick Court, London, W.C.1**

# BRITISH BIRDS



OCTOBER 1958

THREE SHILLINGS

# BRITISH BIRDS

AN ILLUSTRATED MONTHLY MAGAZINE

Edited by

E. M. NICHOLSON

W. B. ALEXANDER                      A. W. BOYD

I. J. FERGUSON-LEES

P. A. D. HOLLAM                      N. F. TICEHURST

*Editorial Address:* 30, St. Leonard's Avenue, Bedford.

*Photographic Editor:* G. K. YEATES

Annual Subscription £2 (including postage and despatch)  
payable to H. F. & G. Witherby Ltd., 5, Warwick Court, London, W.C.1

---

---

## CONTENTS OF VOLUME LI, NUMBER 10, OCTOBER 1958

---

	PAGE
Population and breeding environment of the St. Kilda and Fair Isle Wrens. By Kenneth Williamson. Photographs by Dr. J. Morton Boyd and R.A.F. (plates 61-63) ... ..	369
Photographic studies of some less familiar birds. XCII—Little Shearwater. Photographs and text by John Warham (plates 64-67) ...	393
Notes:—	
Killdeer in Cornwall (R. W. Sims) ... ..	398
The leg colour of the Kittiwake (Ralph Stokoe) ... ..	398
Lesser Black-backed and Herring Gulls nesting on a factory-roof inland in Glamorgan (Col. H. Morrey Salmon) (plate 68) ... ..	399
Magpie's rapid replacement of dead mate (G. R. Shannon) ... ..	401
Letters:—	
Eggs disappearing from Peregrine eyries (G. Harper Hall) ... ..	402
Impressions left by birds striking glass windows (Col. H. Morrey Salmon; Dr. Ernst Schüz) ... ..	403
Recent reports and news. By I. J. Ferguson-Lees and Kenneth Williamson ... ..	405

---

Cover photograph by G. K. Yeates: Corncrake (*Crex crex*), Outer Hebrides



LIBRARY  
NOV 27 1958  
VOL. LI  
No. 10

OCTOBER  
1958



## BRITISH BIRDS

---

### POPULATION AND BREEDING ENVIRONMENT OF THE ST. KILDA AND FAIR ISLE WRENS

By KENNETH WILLIAMSON

(Plates 61-63)

(I) INTRODUCTION

THE FIRST WRITER to mention the existence of a Wren (*Troglodytes troglodytes*) on St. Kilda, over a hundred miles west of the Scottish mainland and half that distance from the Outer Hebrides, was Martin (1698); but it was left to Macaulay (1764) to pose the first of innumerable questions which have sprung from the wonderment of naturalists that such a bird should be there at all: "How these little birds, I mean the wrens particularly, could have flown thither, or whether they went accidentally in boats, I leave undetermined." Later students have found the challenge of the St. Kilda Wren (*T. t. hirtensis*) irresistible, but the pertinent problem has not been that posed by Macaulay so much as what happened to the Wrens once they were there, and how they accomplished such complete mastery of this unusual environment. Almost the first thing learned about them was that they were different from mainland Wrens, and indeed Seebohm (1884) described them as a species new to science, *Troglodytes hirtensis*. When Dresser (1886) complained that this was going too far, the St. Kilda Wren was reduced to subspecific rank, a status which fits well the more dynamic approach to taxonomy that is the vogue today.

Barrington (1884) seems to have been the first to speculate as to why the St. Kilda Wren should be so different from mainland birds; he suspected that exposure to a more humid maritime climate might have much to do with its greater size and greyer-brown colouring. Plumage descriptions have been given by Clark (1915), Harrisson and Buchan (1934) and Witherby *et al.* (1938); it has been discovered that the St. Kilda bird has a unique song (which was sound-recorded in 1956 and 1957), and its nesting-behaviour has been studied by Harrisson and Buchan (1934, 1936) and Bagenal (1958). Study of the differentiation among this

and other insular communities of Wrens in the north-east Atlantic region has received a great stimulus in recent years through the researches of Armstrong (1952, 1953, etc.). Knowledge of the situation in this one species has thrown new light on problems of evolution in general, and it is perhaps for this reason more than any other that continued studies of island communities of the Wren are important.

Some years ago I drew attention to the fact that the Wrens of Fair Isle, between the Orkney and Shetland Islands and 25 miles from each, were distinct from both the typical race and the Shetland subspecies *Troglodytes t. zetlandicus*, and I gave the Fair Isle Wren the name of *Troglodytes t. fridariensis* (Williamson, 1951). Its distinctness from the typical race is less pronounced than in *hirtensis* and *zetlandicus*, but the differences in plumage are constant and incline more to the former than the latter. There can be little reasonable doubt that the Fair Isle community is well insulated from the rest, so that, like the St. Kilda Wren, it is a suitable subject for a population study. As I was to be at both St. Kilda and Fair Isle for periods during the spring of 1957 the opportunity presented itself for gaining a better understanding of the numbers and breeding environment of these two isolated insular populations.

#### (2) THE ST. KILDA WREN

##### *Previous Estimates of the Population.*

Barrington (1884) came across only 6 Wrens in a 3-weeks' stay in 1883, which is surprisingly few since he was a climber and spent much time on and near the cliffs. Dixon reported them as common in 1884, but in the following year the Factor, J. T. Mackenzie, told him that the birds were not nearly so numerous (Dixon, 1885). Mr. Fiddies informed Elliott (1895) that "it was once far commoner than it is at present, especially about the village . . . About 15 pairs would fully represent their numbers on the island now". This must surely have been an underestimate since Elliott himself found or was shown 3 nests. Nevertheless, we must bear in mind the possibility that considerable periodic fluctuations take place; and in any event some decrease in numbers may well have taken place at this time, for at the turn of the century the Wrens (and in particular the accessible ones in the Village) were persecuted for their skins and eggs. (A letter from a St. Kildan in the Norwich Castle Museum, dated 1904, asks for £1 1s. each for adult skins and 12s. 6d. each for juveniles.) However, the fears of Hudson (1894) and others that the race was ever near extinction were quite unfounded, as Fisher (1948b) and Armstrong (1953) have shown.

Serious attempts to census the Wrens began with the 1931 expedition, which recorded 68 pairs for the archipelago—45 on Hirta, 11 on Dun, 9 on Soay and 3 on Boreray (Harrison and Buchan, 1934). Cockburn, who had been at St. Kilda for several

months in 1927 and 1928, and whose study of the geology had given him an intimate knowledge of all the islands, told this expedition that he estimated the total Wren population at under a hundred pairs. Eight years later Nicholson and Fisher (1940) attempted to repeat the survey but could not get on to Soay; they counted 48 pairs, with 31 on Hirta, 12 on Dun and at least 5 on Boreray. In a painstaking survey in July 1948 Ferguson-Lees (*in litt.*) recorded 48 pairs on Hirta and 14 or 15 on Dun, whilst in early August of 1952 about 20 were found on Dun and many on Hirta (Bagenal, 1953). Census work in other years concerned the Village only, and is discussed under the appropriate sub-heading below.

#### The 1957 Census of Hirta.

The above surveys, except for some conducted in the Village area, are open to the serious criticism that they were based on birds heard singing in the daytime and late in the season, when

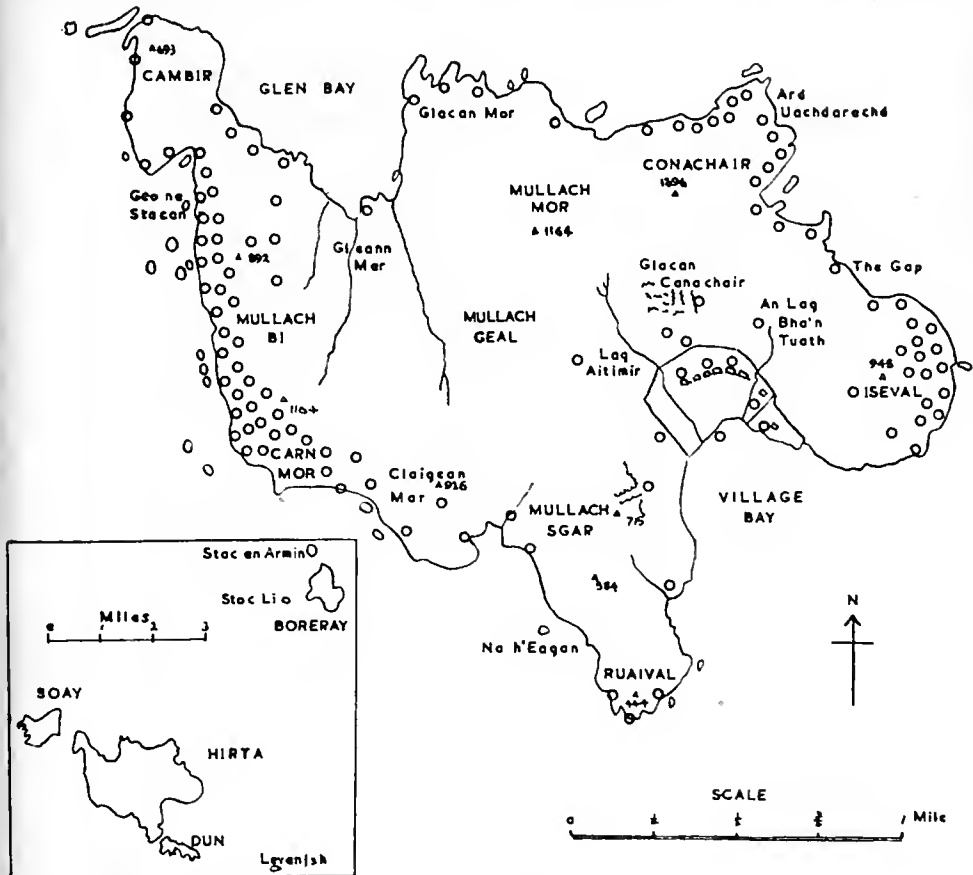

FIG. 1.—MAP OF HIRTA, ST. KILDA, SHOWING THE MAIN CONCENTRATIONS OF WRENS (*Troglodytes troglodytes hirtensis*) IN 1957

Wren positions are indicated by the little circles (not to be confused with offshore stacks and islets). Note the concentrations on Carn Mor and Mullach Bi, on Ard Uachdarachd and Conachair, on Oiseval and in the Village region (see page 373). The inset shows the position of the smaller islands of the St. Kilda group in relation to Hirta.

Wrens are primarily engaged in their domestic affairs and song is desultory. To get a valid idea of numbers and a true picture of distribution a dawn-chorus count before the onset of nesting, in middle or late May, is essential; for only then can one be reasonably sure that the potential breeding males, consolidating their territories, will challenge each other with vigorous bursts of song. As Hirta has about 8 miles of coastline and most of the Wrens are on the cliffs, it was clear that such a survey would take at least a week, examining the coast piece by piece on successive days, fair weather permitting, in the 2 hours or so after sunrise. My counts began on 21st May and continued until the 31st, the last being a re-count of Oiseval to get some idea of the margin of error to be expected along this and similarly difficult reaches; they were made between approximately 04.00 and 05.30 hours G.M.T., the only exception being the 29th when there was much ground to cover and I began at 03.00 hours.

It is perhaps unnecessary to give the several routes in detail: these, with the resulting counts, have been plotted on the one-inch Ordnance Survey map and deposited in the St. Kilda Reserve Record at the Nature Conservancy, 12 Hope Terrace, Edinburgh, for the use of anyone who might wish to repeat the census in future years (Fig. 1). Counting from the cliff-tops (many of which are well over a thousand feet above the sea) is unsatisfactory, for in places there are rock outcrops and talus slopes on grassy terraces between the rocky crest and the sea-cliffs below, so that one finds a complicated distribution with Wrens singing among the crags near the top, Wrens challenging from the talus, and Wrens whispering far below on the final low cliff-fall to the sea. This is especially so of Oiseval, the vast rocky slopes of Mullach Bi on the west coast, and the granite buttress of Ard Uachdarachd which flanks the 1,350-foot precipice of Conachair. Good results can be obtained only by contouring the cliffs wherever the angle of slope and the existence of sheep-paths allows, and in order to cover the west coast in this way it is necessary to sleep out in one of the cleits\* on the boulder-field of Carn Mor.

The counts are given in Table I, taking the main cliffs and coastal slopes in sections west-about from Village Bay. From this Table it is seen that over 85% of the population of Hirta inhabits the cliffs and coastal slopes, which compares with 82% given by Harrison and Buchan (1934). Of the inland pairs 11% are confined to Village Glen and just over 3% to Gleann Mor, where none was recorded in 1931.

#### *Density and Habitat.*

I found that the Wrens are by no means uniformly distributed around the coast. This was to be expected from the work of Harrison and Buchan (1934), who found that Wrens were scarcest on the uniform grassy slopes and low, bare cliffs falling

\*"Cleits" are dry-stone storage-chambers that are dotted all over the island: some can be seen on plate 61 (see Key on page 388).

TABLE I—NUMBER OF WRENS (*Troglodytes troglodytes hirtensis*) SINGING AT HIRTA, ST. KILDA, IN LATE MAY 1957

Locality	Singing ♂ ♂	Probable error (+ or -)
Village Glen	14	—
Ruaival	4	—
Na h'Eagan to Leathaid a Sgithoil Chaoil	3	—
Claigeann Mor and Claigeann an Tigh Faire	5	—
Carn Mor	9	1
Mullach Bi cliffs to Geo na Stacan	29	4
The Cambir and Glen Bay	12	1
Gleann Mor crags	4	—
Glacan Mor to Conachair	4	1
Conachair, Ard Uachdarachd, the Gap	15	2
Oiseval	17	2
Totals	116	11

to the sea. What was new was the quite obvious concentration at certain favoured places, in which the density far exceeds the maximum given for the 1931 survey, with Wrens very scarce or even absent along intermediate reaches. It is probable that these heavy concentrations act as "reservoirs" from which, in peak years, Wrens disperse to the more austere habitats on the flanks.

The chief concentrations on Hirta are: (i) Carn Mor and Mullach Bi, with about 40 pairs along a mile of coast (see plate 62); (ii) Ard Uachdarachd and Conachair, with about 15 pairs occupying a half-mile reach of the cliffs; (iii) Oiseval, with probably 17 pairs over a similar distance (see plate 63), and (iv) the Village region, with 9 pairs (see plate 61 and Fig. 2 on page 382). The great labyrinth of talus and boulders which is Carn Mor has an overflow to the crags of Claigeann an Tigh Faire and Claigeann Mor and the rocky outcrops on the great slopes below these eminences; whilst below Mullach Bi to the north and east birds infiltrate to the Cambir and Glen Bay coast, and the crags on the western arm of Gleann Mor. Conachair and the northern face of Ard Uachdarachd may act as a centre of dispersal to the sparsely inhabited (though to all appearances suitable) gullies of Glacan Mor, while Oiseval and the south-east talus of Ard Uachdarachd probably stand in the same relation to the cliffs below the Gap, and possibly Village Glen behind. The small and comparatively minor group in the Village itself may expand in good years to the hillside territories round about, but this point is discussed later. We must also bear in mind that previous work has shown Dun to be a densely populated isle, and this may well affect the distribution on the adjacent headland of Ruaival.

The optimal habitats are very different in character, and it is likely that a combination of several factors, perhaps differentially important, is needed to produce the ideal environment by providing an abundant food supply, ample shelter, and suitable nesting-sites. The St. Kilda Wren has no predators (the cats, left behind

at the evacuation, have died out), so the factors which might be expected to have the greatest valency are exposure to the prevailing winds (especially in an archipelago so close to the Atlantic storm track), the general physiography, and the nature of the vegetation supporting insect food.

Exposure may not play a significant rôle at St. Kilda (though we shall see that it does so at Fair Isle), for it is on Dun and along the western face of Mullach Bi that the Wren population is densest. These cliffs are so diversified, with their numerous "chimneys", rock outcrops and ridges, and talus slopes that the plentiful shelter they afford may well offset the exposure of this coast to the prevailing winds. J. Morton Boyd (personal communication) has suggested that it may be the winter period of frost and cold, sleet-laden northerly winds which has to be considered more in this connection, since the population is then in poverty and much more sensitive to conditions; and this may explain the scarcity of Wrens in the north-facing rocky gullies of Glacan Mor, where there can be little effective shelter at that season.

The solid geology appears to play a comparatively minor part in the pattern of distribution. The concentrations on Oiseval and Ard Uachdarachd (including the precipice of Conachair) are on the granophyre, whilst Dun, Carn Mor and Mullach Bi are composed of gabbro (Cockburn, 1935). The general configuration of the cliffs is somewhat different: the "glacan" formation of rounded gullies with rocky rims sweeping steeply down to the sea is characteristic of the granophyre at Oiseval and the dolerites of Glacan Mor, and occurs on the landward side of Conachair overlooking the Village; whilst the Mullach Bi coast comprises an upper cliff of much-fractured rock, below which there are steep slopes of maritime grassland intersected by rocky ridges and numerous outcrops, and a low sheer sea-cliff. There is a great deal of broken, eroded rock on all coasts, with accumulations of soil in the interstices supporting a lush vegetation of *Armeria maritima*, *Silene maritima*, *Sedum roseum*, *Cochlearia* spp. and other salt-tolerant and rock-loving plants, and affording far more nesting-places than could ever be required.

The amount of vegetation is not in itself a limiting factor, since the great boulder-field of Carn Mor has precious little other than a few narrow avenues of close-cropped grass, and yet here I found the greatest Wren-density of all—9 or 10 pairs crowded into a space which does not exceed 100,000 square yards. It is of course difficult to work out densities on the cliffs owing to the angle of slope, but measuring roughly from the O.S. map (Mathieson, 1928) it is hardly likely that Oiseval exceeds 300,000 square yards, so that at Carn Mor the density is nearly twice as great. The Village, including the built-up area which extends from the head-dyke at Tobar Childa to the moraine at the foot of Glacan Conachair, is approximately 285,000 square yards and has

only 9 nesting pairs, so that the density on Oiseval is twice, and on Carn Mor three times as great.

Carn Mor is a vast puffinry. That there is a habitat relationship between the St. Kilda Wren and the Puffin (*Fratercula arctica*) was first pointed out by Harrisson and Buchan (1934) with especial reference to the immense puffinry on the island of Dun. Their figures suggest that there are about twice as many Wrens on the Puffin-slopes as on the steep cliffs, and, commenting on this, Armstrong (1953) says it indicates a pair to every 5-7 acres, "a density greater than that noted elsewhere in the islands, with the exception of Village Bay". As we have just seen, this was a mistaken impression, for by comparison with the optimal cliff-habitats the Village must be regarded as a thinly-inhabited environment. During 4 years in the Faeroe Islands, 1941-45, I found the density of *Troglodytes t. borealis* greater on the vast puffinries of Mykinesholmur (similar terrain to Dun) and Nolsoy (talus as at Carn Mor) than elsewhere.

Unquestionably shelter and the presence of Puffins are the greatest factors in the distribution of the Wrens. As Armstrong has pointed out, "the abundant guano fertilises the soil so that there is a characteristic zoopletismic vegetation and a variety of scatophagous insects". This lush growth of *Rumex acetosa*, *Stellaria media*, *Matricaria maritima*, *Angelica sylvestris* and various grasses (Petch, 1933; Poore and Robertson, 1949) reaches a climax on Dun, but there are no similar areas on Hirta, nor probably on Soay and Boreray, since the growth is continually being cropped by bands of wild sheep even on the steepest slopes. The emphasis, therefore, must be on the existence of an insect fauna which is not primarily dependent on rich and varied vegetation, but is attracted in profusion by the litter of sand-eels (*Ammodytes* spp.) dropped from the Puffins' bills, by the remains of adult Puffins slaughtered by marauding gulls (*Larus* spp.), and the hundreds of orphaned young which die of starvation outside their burrows (Williamson, 1958). An additional source of animal remains on Carn Mor, and to a less extent on the smaller talus slopes, is that sick sheep retire into the recesses among the rocks to die, just as they retire into the Village cleits; and observations suggest that the Wrens take advantage of the insect fauna associated with these carcasses (Armstrong, 1953).

Doubtless this explains in part why Carn Mor, despite its apparent barrenness, is the most densely populated Wren habitat on Hirta. The food supply is abundant during the summer months, as are the nesting-sites (there are many cleits, in addition to rock crevices), and there is ample shelter in the labyrinth of huge boulders on stormy days. Much of the maritime grassland of the Mullach Bi coast beyond has small colonies of Puffins, and there are large ones at Geo na Stacan and the talus of the south-east face of Ard Uachdarachd. The Puffin is also common in the gullies of Oiseval and there are considerable numbers among the

crag of the western arm of Gleann Mor, where are the only inland-nesting Wrens outside Village Glen. Indeed, it is true to say that the only group of Wrens which is not associated with Puffins is that occupying Village Glen—and, as we have seen, this area is sparsely inhabited by comparison with parts of the coast.

*Total Population.*

Unfortunately I was not able to carry my survey to the other islands (Fig. 1, inset). It would be impracticable to remain long enough ashore on Soay and Boreray to make a series of dawn-counts, for getting on and off these islands is a hazardous undertaking and the weather in spring is unreliable. Both rise to over 1,200 feet and the cliffs are immense, and it would not be possible to form a reliable opinion of the number of Wrens present in the few hours which is all that previous parties have had ashore.

A dawn check of Dun, on the other hand, should be practicable: it is small enough to be covered by a couple of observers in one period of dawn-song, and although landing from a boat is difficult the isle can be reached (provided one is prepared to spend 12 hours ashore) by boulder-hopping across Caolas an Dhuin at low spring tide. Ferguson-Lees's traverse on a July day in 1948 was very thorough, and took note of singing birds, family parties, and single individuals where it appeared that these were part of discrete breeding units. Nevertheless, Dun is not easy to work and July is a bad time for census work since many St. Kilda Wrens are still engaged in incubation or in feeding young in the nest. The 14-15 pairs counted may be taken as a minimum, and the actual population is probably many more.

All these are gabbro islands and it is likely that the density of Wrens is comparable with that of the Mullach Bi coast of Hirta. The south-east face of Soay has a huge boulder-field similar to Carn Mor, and rocky outcrops are numerous up to 900-1,000 feet. It is well-known that this part of Soay harbours a vast puffinry, bigger than any on Hirta. Boreray also has large Puffin-colonies, though most of these are on grassy slopes; and although there is little talus on its cliffs they rise to spectacular pinnacles and arêtes, particularly in the northern half. It is smaller than Soay (190 against 244 acres) but has a greater proportion of cliff-terrain to grassy slopes. The fact that the "5+" Wrens recorded for Boreray in 1939 were all near the Sunadal slope on the north coast (Fisher, 1948a) argues a big population on this isle, and it is not likely to be less than that of Soay.

TABLE II—ESTIMATED TOTAL POPULATION OF ST. KILDA WRENS (*Troglodytes troglodytes hirtensis*) IN 1957

Island	Estimated total pairs
Hirta	116)
Dun	25)
Soay	45) = 233
Boreray	45)
Stac an Armin	2)



When members of the National Trust for Scotland visited St. Kilda in mid-July I was invited on board *M.V. Turquoise* for a circumnavigation of the islands. From what I then saw of the cliff-formations, and had previously learned about the Wren distribution on Hirta, I estimate a total St. Kilda Wren population in 1957 of not less than 230 pairs, made up as shown in Table II. Clarke (1912) was told that the Wren bred on Stac an Armin, which lies to the north of Boreray and at 627 feet is the highest sea-stack in Britain; and having viewed it from the sea I feel there might well be 2 or even 3 pairs associated with the big puffinry and broken crags of its south-eastern slope. Donald Gillies (personal communication) confirms that Wrens were present on Stac an Armin, and Coekburn (personal communication) says there was sufficient sheltered grassland on this stack to warrant the St. Kildans grazing 7 sheep there during the summer months.

#### *Fluctuations in Numbers in Village Glen.*

Almost all the parties which have visited St. Kilda since the evacuation of August 1930 have had something to say about the Wrens of the Village and its vicinity. Their status has been discussed in the light of the available records (up to 1951) by Armstrong (1953), but for a number of reasons the material available even at the present time does not form a very satisfactory basis for discussion. Table III gives the raw data abstracted from previous papers, and embodies observations made since Armstrong's study was written.

In interpreting these data a number of difficulties arise. Fisher (1948a and b) thought there was evidence that the Village population had remained stable over the previous 16 years, and that this must reflect stability in the Hirta population as a whole; over the longer period of 27 years since the evacuation, however, there is a strong suggestion in the figures of instability, and perhaps even of a recession in the Village area since 1952. Unfortunately, we cannot be sure that the several censuses are strictly comparable. The first difficulty encountered is one of definition, for in some cases it is not clear from the context if "the Village" means the region enclosed by the head-dyke or perimeter wall, or this enclosure together with the complex of buildings in the Tobar Childa area immediately beyond the wall at the foot of Conachair, where the mediaeval village was situated. The point is important because in 1957 2 pairs held adjacent territories in this assemblage of cleits, mediaeval hovels and walled "erubs", one immediately north-west of the well, and the other on the moraine above—so that only 7 pairs were contained by the enclosure wall. The wall is a very imprecise boundary, since birds may conceivably nest outside it and yet occasionally use the dyke and cleits immediately inside it as singing-stations. This lack of precision admits a possibility of error of the order of 20%, which is much too great

TABLE III—SUMMARY OF RECORDED COUNTS OF THE WRENS (*Troglodytes troglodytes hirtensis*) IN THE VILLAGE AREA, HIRTA, ST. KILDA, 1931-57

Year	Period	Authority	No. of pairs	Statement of locality	Nature of evidence
1931	July 22nd to Aug. 14th	Harrisson and Buchan (1934)	11	Between street and sea, 1; along street, 7; behind street, 3 (p. 138)	"Pairs": 12 nests in buildings included one in cleit at Ruaival (p. 137)
1938	July 23rd to Aug. 9th	Harrisson and Lack (1934)  Atkinson <i>in litt.</i> to Fisher (1948b) and Armstrong (1953); also Atkinson (1949)	8  12	"Concentrated round the Village area"  (Presumably Village enclosure)	"Pairs"  Nests: 9 occupied but 12 in which young had been reared
1939	May 31st to June 2nd	Nicholson and Fisher (1940)	12	"The Village"	Presumed pairs, based on count of day-singing birds
1947	June 10th to June 19th	Fisher (1948 a and b)	10	"The Village"	"Pairs", based on day-singing birds
1948	July 10th to July 21st	Ferguson-Lees <i>in litt.</i> to Armstrong (1953) and present author	11	Village enclosure, including perimeter wall	Birds in song, family parties, nests in use
1949	May 21st	Fisher <i>in litt.</i> to Armstrong (1953)	10	(Presumably Village enclosure)	Count of day-singing birds
1951	June 13th	Armstrong (1953)	9 or 10	"Village enclosure"	Dawn-song: Armstrong gives "10" in Table but says this was "perhaps one too many" (p. 132)
1952	July 24th to Aug. 10th	Boyd (1954)	12 or 13	Village enclosure, with part of one bird's range extending outside perimeter wall in Tobar Childa area	"Family groups"
1955	May 24th to May 29th	Boyd, Munnis and Whitehouse (1956); and Boyd ( <i>in litt.</i> )	6	Village enclosure and one near entrance to An Lag Bho'n Tuath	Dawn song
1956	June 11th	Nicholson and Fisher <i>in litt.</i> to Boyd	7	Village enclosure	Day count of singing birds
1956	June 24th and June 27th	Boyd, Tewnion and Wallace (1957); and Boyd ( <i>in litt.</i> )	5  8	Village enclosure, and along perimeter wall  Village enclosure, and along perimeter wall	Dawn song  "Family groups"
1957	Late April and all May	Present author	9	Village enclosure and Tobar Childa region including moraine at foot of Conachair	Dawn song on many dates

to warrant a detailed analysis and comparison of the several seasons. A difference of opinion as to what constitutes "the Village" may account for the wide disagreement in the statements quoted in the Table for the 1931 survey.

Counts of family parties seen late in the season cannot be admitted as evidence of the number of broods actually reared within the confines of the enclosure wall, or even within the wider "Village area" as defined above. Once broods have left the nest the home territory is sometimes forsaken and the families wander. Such groups may invade the Village area from the hillsides round about, for inside the wall and at Tobar Childa shelter abounds and there is probably a far better food supply than on the bare hillsides. There was not much evidence of such movement in 1957, although the second brood of the Tobar Childa pair moved inside the head-dyke within a few days of leaving the nest; but the Factor's House brood quickly left their home territory to wander westwards, and what can happen in a comparatively fertile corner of Village Glen is even more likely to happen in the outer ring of bleak hillside territories. The fact that Harrison and Buchan (1934) recorded "several broods of one flying young only" suggests a further complication in that after leaving the nest the broods may become split up.

We must also be careful not to compare day-song counts made late in the season with dawn-song counts made in late May and early June, and *vice versa*, for when there are young in the nest it seems that some males may not join in the waning dawn chorus, presumably because the early morning hunger of the nestlings is a more urgent stimulus to their activity. They may sing spasmodically later in the day. At Fair Isle 2 males which I missed on separate occasions at dawn in late June were in song at other times, and in both cases the pair was feeding young. This might explain the discrepancy in the counts for 1956, since Fisher and Nicholson found 7 birds singing by day on 11th June, whereas 3 independent observers could locate only 5 at dawn on 24th and 27th June, although there was regular day-time song at 2 other sites.

Bearing these difficulties and discrepancies in mind, the most we can say is that over the Village area as a whole the population appears to have fluctuated between 6 pairs (1955) and 12 pairs (1952 and several previous years); and that there is some appearance in the figures of a decrease since 1952, which may reflect a general trend within the population, or might indicate that the Village area is becoming less suitable as a Wren habitat. The St. Kildans were permitted to return to the Village in summer till 1938, which means that there would still be a certain amount of offal in the middens attractive to insect life. This has now disappeared. Of late years there have been vegetational changes which may have reduced the potential feeding-area still further, due to heavy grazing by bands of Soay Sheep, and the rapid

spread of bracken (*Pteridium aquilinum*) which, from being confined to one small patch in 1930 (Donald Gillics, personal communication), has now achieved full dominance over a very wide area east of An t'Sruthan and in Lady Grange Field. It is also possible that the phenomenal increase and spread within the head-dyke of the Field Mouse (*Apodemus sylvaticus hirtensis*) following the extinction of the House Mouse (*Mus musculus muralis*) in the middle 1930's, could have adversely affected the Village as a Wren habitat, since in summer the two are competitors for insect food.

There is reliable evidence of fluctuations on the hillsides around the Village. In 1957 these slopes had a total of 5 dawn songsters ranging from St. Brianan's (but perhaps this should be regarded as a coastal pair) to An Lag Bho'n Tuath. Harrisson and Buchan (1934) found no Wrens at all on the slopes of Village Glen in 1931, nor did Armstrong and Westall 20 years later, nor did Boyd in 1955. Fisher (1948a) heard 4 on the hillsides in 1947. Ferguson-Lees gathered evidence of no fewer than 14 pairs or family groups over this range in July 1948, and although this count was made at a time when broods were on the move and some possibly split up, and birds may have wandered in from the cliffs, it certainly suggests that 1948 was a peak year in which more pairs than usual were forced to settle in this austere zone. The Village itself may be the "reservoir" from which these outer territories are settled, but this is perhaps unlikely since its potential output is small compared with that of Oiseval and Ard Uachdarachd near-by, and after a good winter there is probably an overflow to the valley from these cliffs. This would be likely to affect An Lag Bho'n Tuath especially, and in this hanging valley Ferguson-Lees found 2 nests and 3 broods of young in 1948.

#### *Territory Size.*

Except in recent years, few efforts have been made to delimit the territories of the Village Wrens, but it is clear from existing information that the situation of some territories remains much the same from year to year. Eagle Clarke (1912) was shown a nest among dead thrift on the low earth cliff fringing the storm-beach; Harrisson and Buchan (1934) found 3 nests along this cliff and thought there were 2 pairs in 1931; and there was at least one pair in the same locality in 1952 and each year during 1955-57. The immediate vicinity of the Factor's House has been mentioned frequently as a Wren site: Harrisson and Buchan watched at this nest in 1931, Atkinson (1947) photographed a nest in 1938, and there were broods in 1952 and each year during 1955-57. Another territory, occupied at Armstrong's visit in 1951, again in 1952 and each of the past 3 years, is centred on the middle of the Village Street, close to the graveyard; and the cottages at the western end of the Street had a pair in 1952 and during 1955-57. Lag Aitimir and Tobar Chonastan were occupied hillside sites in 1956 and 1957.

As one would expect from the less congenial nature of the environment, the territories of the outer ring are more diffuse and extensive than those in the Village itself, but "probably the periphery of large territories should be regarded as a singing range rather than an area which is seriously defended" (Armstrong, 1956). Late in April 1957 2 males were counter-singing in An Lag Bho'n Tuath, but one soon disappeared, and in early May and subsequently the remaining bird ranged over a wide space in this small hanging valley. At that time a dawn songster was to be heard among the cleits of Lag Aitimir on the west bank of Amhuinn Mor, but in the third week of May it was more often in song among the cleits at Creagan Breac 300 yards uphill to the west. The bird at Gearraidh Ard ranged over a similar distance among cleits and walled enclosures on the moraine at the foot of Mullaeh Sgar, sometimes singing from the serrees below Clash na Bearnich, and sometimes from cleits just above the coast. Another had the whole of Glaean Conachair to itself, and one wonders if this series of rocky gullies with their lush vegetation is the site "on the shoulder of Conachair" reported by Newton (1902).

It is clear that the size of the territory must vary within rather wide limits, depending upon whether the bird belongs to a group in one or other of the optimal cliff habitats where pressure is great, or occupies a more austere part of the coast or section of hillside where there is practically no pressure at all. As Armstrong (1956) points out, "Vigour in relation to competitors determines a bird's status among his fellows, and it is the sum of the vigour of a group of competing birds which determines the upper limit of numbers in a given area. Kendeigh (1941) has shown for the House Wren (*Troglodytes aëdon*), more clearly than has been shown for any other species, that the size of territory tends to vary, within limits, inversely with population density. This is apparently true, *ceteris paribus*, of the Wren, and probably is generally true." The fundamental concept of territory, he suggests, should be vigour rather than area, although measurement of area provides one means (and perhaps the most practical) by which this can be assessed.

The only region where territory size can be gauged with any degree of accuracy is the Village, and this, as has been stressed, is by no means an optimal environment. Harrison and Buchan (1934) assessed the Village territories at between 3,000 and 5,000 square yards, while Ferguson-Lees's estimate was 3,500 square yards—figures which conflict strikingly with my own and those of Armstrong (1953), whose data, allowing for the existence of neutral zones between some of the holdings, indicate territories of "not less than 15,000 square yards," with some probably considerably larger.

Believing the Village to be "a congested area", Armstrong under-estimated the size of these unoccupied neutral zones; they are in fact of considerable extent, particularly in the western

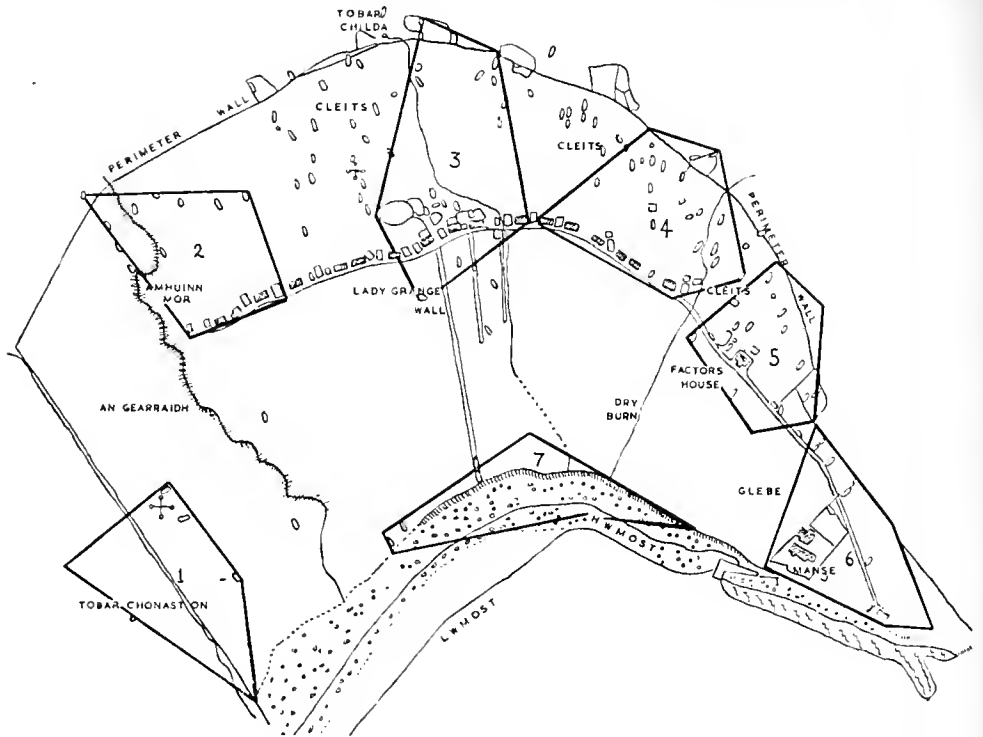

FIG. 2—PLAN OF VILLAGE AREA, HIRTA, ST. KILDA, SHOWING THE APPROXIMATE BOUNDARIES OF THE TERRITORIES OF WRENS (*Troglodytes troglodytes hirtensis*) IN 1957

The sizes of these seven territories are given in Table IV where it will be seen that they averaged just over 13,000 sq. yds. (the two other "Village area" pairs were outside the perimeter wall). In the map on Fig. 1, which excludes the shore area, the storm-beach territory (No. 7) appears as if just offshore.

segment of the enclosure and the meadows between the storm-beach and the Village Street. When the Village Wrens had settled down in early May it was not difficult to plot the alternative song-posts of the individual males, and join them together on the scale chart of the Village (Mathieson, 1928). A computation based on this method must of course be approximate, since the territory is thus defined as the area enclosed by the straight-line distances between the outermost singing points. It is as well to return to Armstrong's view of territory, quoted above, and to emphasize that this method merely gives us an area which each bird is known to defend by song at the outset of the breeding season, and that the limits of this area must remain ill-defined because vigour in defence weakens towards the periphery. The method, although it has undoubted limitations, seems likely to be the only one which will provide comparative data for the various males.

The approximate sizes of the 7 territories studied are shown in Fig. 2 and Table IV, and it will be seen that they average just over 13,000 square yards, rather less than Armstrong's minimum. At first sight this suggests a concentration not remarkably below

that on Carn Mor, where 9 or 10 pairs occupy about 100,000 square yards; but if the Village area is taken as a whole we find that there are these large neutral tracts, and a computation based on the whole region occupied by the 9 pairs shows that there is, on an average, one pair to every 31,600 square yards. In other words, as already noted, the density on Carn Mor is nearly three times as great, and the territories there must have little or no neutral ground between. The comparison suggests that where the population is high in an ideal habitat a minimum average size is of the order of 10,000 square yards, and in marginal areas where it is comparatively low the maximum area a St. Kilda Wren is prepared to defend by song might be as much as 19,000 square yards. This is not much greater than the 2 to 3 acres (say 14,000 square yards) which is a fairly average territory size among garden and woodland Wrens, but in the typical race one must expect greater variability as the males are often polygamous and there may be several occupied nests in one territory, and indeed size may vary from about 5,000 square yards to over 30,000 square yards (Armstrong, 1956).

TABLE IV—APPROXIMATE TERRITORY-SIZE OF WRENS (*Troglodytes troglodytes hirtensis*) IN VILLAGE AREA, HIRTA, ST. KILDA, IN 1957

No. on Fig. 2	Locality	Territory in sq. yds.
(1)	Tobar Chonastan	12,280)
(2)	West Meadows	11,300)
(3)	An t'Sruthan	19,000) Average:
(4)	Cottages nos. 1-2	14,500) 13,250
(5)	Factor's House	10,500) sq. yds.
(6)	Manse	11,900)
(7)	Storm-beach	13,250)

It will be seen that pair no. 7 held a "ribbon" territory extending practically the full length of the low earth cliff between Amhuinn Mor and the outlet of the Dry Burn. There was no "ribbon"-development in the Village, such as has appeared to some previous observers, for each territory extended at right-angles to the Street with the ruined cottages at one end and the perimeter wall at the other, and an extensive potential feeding area in the meadows and among the cleits and other structures between. There was a strip between nos. 3 and 4 where defence was weak, but occasionally the males challenged each other from the gable-ends of adjacent cottages, and inclusion of these rarely used singing stations may have inflated the size of these two territories to some extent. The only territories which really marched together were the two beyond Tobar Childa, and nos. 4, 5 and 6. There appears to have been a similar situation with regard to the last trio in 1931.

It was noticeable that territorial defence broke down completely once the young had left the nest. Family no. 5 moved westwards

through the territory of no. 4, without let or hindrance, to the periphery of no. 3, before the last two pairs had their young on the wing. Meanwhile the Manse brood invaded the no. 5 territory for a time, and in mid-July resorted to the boulder-beach and rocks in front of the Manse.

*Spread of Nesting.*

Armstrong (1952, etc.) has shown that there is a greater spread of nesting among northern insular Wrens than among mainland ones. It is possible that the generality of St. Kilda Wrens are late breeders because their economy is geared to the nesting-season of the Puffin, which does not breed until mid-May and leaves the cliffs in August. Dixon (1885) says, "its breeding-season must commence early in May, for the young were three-parts grown by the beginning of June", but this has not been the experience of most subsequent observers. Elliott (1894) found a nest containing 5 fresh eggs, and another in which laying had just begun, on 11th-12th June, and a nest with newly-hatched young on 20th June. The Keartons (1899) saw no young on the wing until they visited Soay in the third week of June, but possibly first clutches in the Village had been robbed. Harrisson and Buchan (1934) had no evidence of fledging before 30th July, when 3 young and their parents were seen on Dun; other broods fledged on 2nd and 4th August, and in another nest the eggs hatched on the 6th. These must surely have been second broods.

In 1957 the Tobar Childa bird was found sitting on a full clutch of 5 eggs on 23rd May: the parents were seen carrying food on 4th June, and the young left the nest on the 13th. A second brood of this pair was on the wing in mid-August. The first nest, like that of nos. 4 and 5, was placed under the roof-lintels inside a cleit. Another early pair, nesting in a hole in the low beach-cliff, behind a clump of sea-campion, fledged their first brood on 10th (one chick) and 11th June, and they too had a second brood on the beach in mid-August. Pair no. 4 completed a clutch of 6 eggs on 22nd May, but it was stolen soon afterwards: in early June the male sang often during the day and was much more active vocally than any other in the Village. They nested again under the roof-top of a tiny stone dog-kennel behind one of the "black houses" and raised a single brood. Pair no. 5 had finished their nest except for the feather lining on 18th May (the male had also been taking material to a poorly-built "cock's nest" in a cleit 100 yards away), and, laying an egg each day, completed their clutch of 5 on 29th May. The young were ringed on 27th June, were still in their nest on 3rd July when Bagenal (1958) made observations on their feeding, and were not seen outside their cleit until the 8th. This gives a combined incubation plus fledging period of 40 days, which exceeds Armstrong's (1952) figure of  $14 + 16 = 30$  days for the Shetland race and appears to be a week more than the average for the typical race (Armstrong, 1955).



The Manse birds chose a hole in the turf covering outside a cleit and their young flew on 2nd July and were still being attended by their parents on the beach in front of the house on the 26th-27th, when the dawn-song of the male was recorded on tape. At the middle of the Street the first nest of no. 3, built into a little pocket under the collapsed turf roof of a byre, was deserted for an unknown reason, after 2 eggs had been laid, before 18th May. This pair also had young among the houses on 8th July. The only nest found on Carn Mor was under the roof-lintels of a cleit (the most popular site among the Village Wrens), the bird being flushed from 5 eggs on 26th May. These records are given in detail to show that the spread in nesting, at least in the marginal Village environment, is very real and similar to that found in the Shetland Wren (Armstrong, 1952); and that only the earliest pairs, with their first young leaving the nest in mid-June, are likely to prove double-brooded.

### (3) THE FAIR ISLE WREN

#### *Population and Habitat.*

I expressed the view that in 1950 the population of the Fair Isle Wren was between 30 and 40 pairs, "all nesting on the coast" (Williamson, 1951). This figure was arrived at by plotting the singing stations on a number of day-time walks along the cliff-tops in May and June. As birds which happened to be silent on one visit to a particular sector were likely to be heard and plotted on a subsequent visit the count may not have been very far out; nevertheless, I now think it is certain to have erred on the low side.

In the latter part of June 1957 I assessed the Fair Isle population again, this time by dawn counting. A few pairs were already feeding young in the nest, and at 2 sites birds were heard singing during the day but were not heard in the dawn period. As at Hirta, I worked the cliffs in adjoining sections on different days in the 2 hours or so following sunrise, and was able to cover most stretches at least twice, besides re-visiting several sectors in the afternoon and evening as well. Thus the picture emerging should be an accurate one, despite the lateness of the season.

By comparison with the flourishing condition of the St. Kilda Wren the Fair Isle population seems precariously poised. Of course, it is possible that the two populations were out of phase, in the sense that the St. Kildan may have been at a higher-than-average density and the Fair Isle one at a comparatively low ebb, but it did not strike me that the latter was materially changed from previous years. There were almost certainly not more than 50 pairs in 1957. My count of the perimeter gave 48 pairs, and it is possible there was one other in the Geo of Sheep Craig, a massive stack on the east coast which I was not able to visit, but which had breeding Wrens when I was ashore there in 1953. I have been regularly at Fair Isle in summer since 1948, and a few haunts which had Wrens in other years were vacant in 1957, so in all likelihood there are fluctuations as at St. Kilda and 1957 was

probably not a peak year. The survey was plotted on a copy of the 6 inch Ordnance Survey Map of the isle which is deposited at Fair Isle Bird Observatory, and a detailed report appeared in *F.I.B.O. Bulletin*, vol. 3, pp. 184-187.

Fair Isle differs from Hirta in many respects. Although the land-area is greater by some 500-600 acres it is a much easier island to survey since the cliffs are comparatively low, reaching their greatest height below Ward Hill in the north-west at about 600-650 feet. The west and north coasts have cliffs generally between 300 and 400 feet high, and along the eastern side they are generally much lower than this. They are fairly sheer—precipitous in many places—and without intervening grassy or boulder-strewn terraces. In consequence, one does not have the complication of a vertical as well as linear distribution which one finds round the St. Kilda coast. Fair Isle is composed of red sandstone and in general the cliffs are rather bare except for patches of grass and small tufts of thrift, campion and other rock-plants, and there is a good deal of exposed, friable rock and earth slides which do not encourage vegetation. There are small puffinries at several points, but these do not compare in magnitude with those of St. Kilda, and there is no marked association between Puffins and Wrens. The coast-line is much indented, far more so than at Hirta, so that there are many sheltered inlets or “geos”, most of them with a small storm-beach at the head.

These geos are the chief habitat of the Fair Isle Wren; they afford shelter, and I have seen in past years as well as in 1957 that the birds feed much among the wrack cast up on the beaches by the high spring tides. It is possible that Crustacea and other small marine organisms, as well as the larvae of dipterous insects which breed in the wrack (food such as the great majority of St. Kilda Wrens are unable to obtain) form a considerable part of their diet. Of the 48 pairs only 5 (10%) were singing close to puffinries of any size, whilst no fewer than 29 (60%) were found near shingle or boulder beaches in the geos. It is interesting to note that at two of the biggest puffinries, on Burrista and Da Toor o' Ward Hill, there were 4 singing Wrens, but that these were associated with the geos on either side and not with the Puffin-colonies themselves. There were no Wrens anywhere near the largest puffinry, at the Holms off Malcolm's Head in the south-west.

Two other features of the distribution are important in showing a marked divergence in habitat-selection from the St. Kilda birds, enforced by the less diversified nature of the cliff-terrain. There is a marked tendency at Fair Isle to avoid the exposed south and west coasts, since these have few features affording good shelter from the prevailing winds, and although the west has the highest cliffs it has only 18 of the 48 pairs (34%), and with few exception these are in the lee of headlands or the shelter of narrow geos. There are, for example, 4 pairs along the quarter-

mile lee coast of Malcolm's Head (353 feet), but none at all along the half-mile stretch facing south-west. In fact, this quadrant of the isle has only a single pair holding the 300 yards of storm-beach at South Harbour—a locality which, one feels, ought to support 2 or 3 pairs. Even along the east coast the Wrens are concentrated in three major groups each in a bay sheltered from the south by a promontory.

The third striking difference is that there is not a single pair in the crofting area, although this is the most fertile third of the island, has an abundance of nesting-places in the outhouses and byres, a number of small sheltered "crubs" and gardens, and open middens adjoining the crofts. It is not until the young are independent in late July and August that there is any movement of Wrens to inland sites. With knowledge of the situation at Fair Isle, Craw (1951) was surprised to find Wrens in a number of inland localities on Foula, which is 16 miles west of Shetland Mainland, on 19th May 1951; and in other parts of Shetland the local race *setlandicus* breeds away from the cliffs, though it prefers moorland burns and rocky declivities to stands of trees and shrubs (Armstrong, 1952)—as does also *borealis* of the Faeroe Islands.

#### (4) DISCUSSION

It is considered likely that the Wren reached the Old World not earlier than the Pleistocene, crossing from the Nearctic Region by the Bering Strait land-bridge and spreading westwards across Asia and Europe (Mayr, 1946; Armstrong, 1953). The species may therefore be said to have reached its *ultima thule* in the remote islands of the north-east Atlantic—Iceland, Faeroe, Shetland, Fair Isle, the Outer Hebrides and St. Kilda—where subspeciation has already proceeded to a marked degree.

In Britain the two most isolated populations, those of St. Kilda and Fair Isle, inhabit the sea-cliffs, avoiding only the most desolate and exposed reaches. To some extent this is also true of *borealis* of Faeroe, *setlandicus* of Shetland and *hebridensis* of the Outer Hebrides (and also, of course, of the typical race in certain localities), though in all these cases there is a much wider latitude in the choice of habitat, and inland nesting among hillside crags, rocky declivities, moorland burns, and among trees and shrubs (*hebridensis* and the typical race) is common. It is interesting to find that adaptation to a coastal environment differs rather widely between the two races *hirtensis* and *fridariensis*. At St. Kilda, we find a marked association with the big puffinries, whereas at Fair Isle (where big sea-bird colonies are lacking) the Wren is markedly dependent on small sheltered geos with their wrack-strewn beaches—a topographical feature practically absent from St. Kilda. Thus, so far as habitat-selection is concerned, the nature of the terrain has brought about divergence not only between the mainland and northern insular Wrens, but also between the northern insular stocks themselves.

Although differences in the physiography have determined the

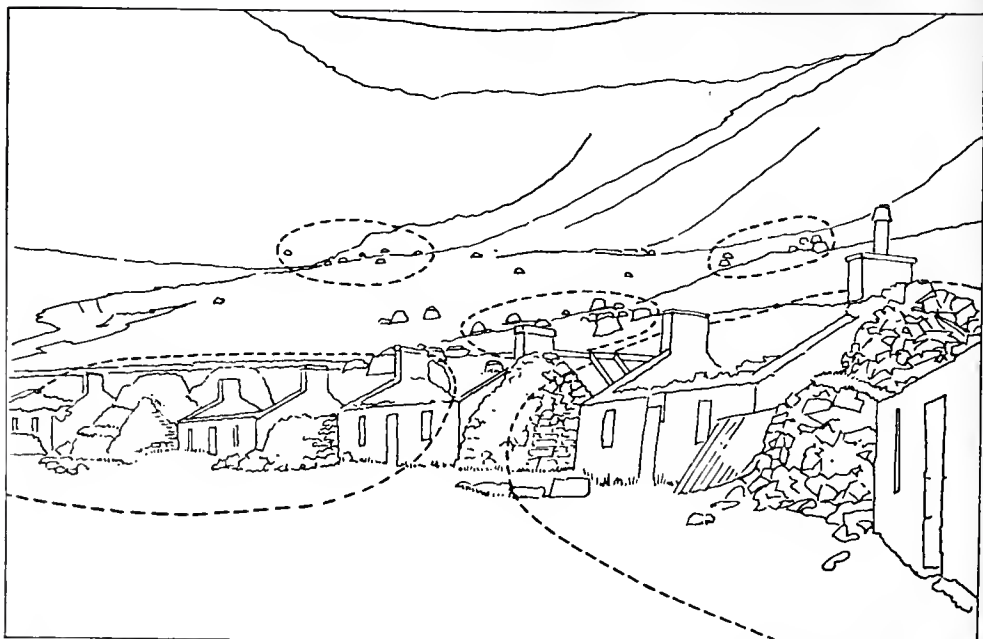

FIG. 3—KEY TO PLATE 61 TO SHOW THE BOUNDARIES OF FIVE TERRITORIES OF WRENS (*Troglodytes troglodytes hirtensis*) IN THE VILLAGE AREA, HIRTA, ST. KILDA, IN 1957, WHICH ARE COVERED BY THAT PHOTOGRAPH

*Left foreground*: middle of Village street and meadows behind. *Right foreground*: cottages nos. 1-5 and meadows behind. *Centre*: Tobar Childa "cleits". *Left background*: Lag Aitimir "cleits". *Right background*: "cleits" on moraine at foot of Conachair.

particular niche which the St. Kilda and Fair Isle Wrens must fill, it is possible that a difference in food-preference is also involved, since the first requirement of any species is a source of food-supply sufficiently plentiful in summer to provide for a family or families of young. It may be that the successful exploitation of each niche is attributed to the fact that the staple diet of *hirtensis* consists of terrestrial (perhaps largely scatophagous) insects, whilst that of *fridariensis* comprises small marine organisms and the larvae of seaweed flies. Few direct observations on the nature of the food taken to the young have been made at either place, except by Harrison and Buchan (1934) in the atypical Village habitat on St. Kilda, and this is a matter urgently requiring investigation in the light of Armstrong's (1958) recent discussion of the factors affecting subspeciation in the Wrens. He points out how differences in behaviour patterns are so integrated that variations in one tend to involve correlated variations in others, and that, theoretically, these integrated divergences could raise an effective barrier to interbreeding between various populations. "Scrutiny of Wren adaptations", he says, "suggests that speciation may occur through the modification of a group of behaviour patterns determined primarily by the nature of the habitat and the character of the food supply". Whether or not the insect life dependent upon the great sea-bird colonies on the



J. Morton Boyd

THE RUINED VILLAGE, SURTIL ON HURVA, ST. KILDA, WITH THE RIDGE OF MULLACH MOR BEHIND. On the right is the scree below Glacan Conachair, and under it (centre) the heather-covered moraine with the "clivits," and mediaeval hovels of Tobar Childa at its foot; on the left is the gorge of Anluinn Mor below Lag Aifimhir (place-names are shown in Figs. 1 and 2 on pages 371 and 382). This photograph embraces parts of five of the Village-area territories of the St. Kilda Wren (*Troglodytes troglodytes hirtensis*) in 1957 (see Key; Fig. 3, facing).



*R. A. F. Photograph, Crown Copyright Reserved*

PART OF THE WESTERN CLIFF-SLOPES OF HIRTA, ST. KILDA: 2411 APRIL 1957  
This shows maritime grassland with gabbro outcrops below Claugann an Tigh Faure (949 feet), with the great boulder-terrace of Carn Mor on the right. The photograph takes in some fifteen of the territories of



R. J. F. Photograph, Crown Copyright Reserved

THE GULLIES OF ORSTVA (p. 8, left), HUCA, St. Kilda; 24.10. April, 1957.  
In 1957 some seventeen pairs of St. Kilda Wrens (*Troglodytes troglodytes hirtensis*) nested among these gullies (the sea is in the bottom left and the cliff-top on the right). This and plate 62 are aerial obliques from 12,000 feet; these two cliff-sections held the greatest concentrations of Wrens (see Fig. 1 and page 373).



John Warham

LITTLE SHEARWATERS (*Procellaria baroli*) "PUFFING": Eclipse Is., W. AUSTRALIA  
 Black above and white below, this species is like a three-quarter-sized Manx Shearwater (*P. puffinus*), but note how the dividing line between the black and the white on the head passes through the eye and not below it as in the larger bird (see page 394); the beak is greyish-black, and the legs and webs are light blue. As with other shearwaters, "duetting" is a common part of courtship-behaviour: note the arched nape of the bird on the right (see page 396).





John Warham

Little Shearwater (*Procellaria baroli*) feeding chick; Easter Is., W. Australia

The adult opens its beak wide, the chick inserts its own at an oblique angle on top of its parent's tongue and the food is thus transferred; the chick then withdraws, both swallow, and after a pause the cycle is repeated (see page 397). Usually only one parent comes to the burrow on any particular night (like other shearwaters, the species is nocturnal at its breeding-places). The chick is grey above, lighter on the belly and almost white on the throat (see page 395).



John Warham

LITTLE SHEARWATER (*Procellaria baroli*) PREENING HEAD OF CHICK  
When the adult arrives in the burrow, the nestling cheeps continuously and dives its beak at its parent's head; the old bird may then preen the chick's head and this leads to fencing with bills (see below).



John Warham

ADULT AND YOUNG LITTLE SHEARWATERS (*Procellaria baroli*) BILL-FENCING  
ECLIPSE IS., W. AUSTRALIA  
Bill-fencing follows the head-preneering stage (see above) and the young bird continues to call vigorously. The adult then opens its beak wide and the feeding described on plate 65 follows (see also page 307). Note again in these two photographs how the dark cap ends at the eye in this species (see plate 64).



John Warham

ADULT LITTLE SHEARWATER (*Puffinus baroli*) RUBBING HEAD ON BACK

This serves to emphasize the contrast between the black above and the white underneath in this species. The single chick stays in the burrow for 70-75 days (and incubation lasts 52-58 days) (see page 305).



John Warham

LITTLE SHEARWATER (*Puffinus baroli*) IN FLIGHT AT NIGHT  
ECLIPSE IS., W. AUSTRALIA

The flight is much more fluttering than that of the larger shearwaters, the wings being beaten very rapidly, but in stormy conditions the birds may also bank and glide like the bigger species (see page 304). The Madeiran race (*P. b. baroli*), the most likely to occur in Britain, has white under tail-coverts like this (see page 304).



H. Morrey Salmon

LESSER BLACK-BACKED AND HERRING GULLS (*Larus fuscus* and *argentatus*) NESTING ON A FACTORY-ROOF AT MERTHYR TYDFIL, GLAMORGAN: 12TH JUNE 1958

This curious colony, not recorded until 1958 although in existence for some 13-14 years, is 2½ miles from the sea and combines two uncommon traits of these species: roof nesting and nesting in pairs.

one hand, and the fauna of the beach debris on the other, have respectively oriented the behaviour of the St. Kilda and the Fair Isle Wrens only a critical assessment of their food-habits can show.

In his discussions of Wrens Armstrong has made a distinction, which he emphasizes is ecological, between a "fertile" mainland or Continental and a "bleak" northern insular environment. Birds of the garden-woodland habitat are prone to polygamy, the male has leisure to build auxiliary "cock's nests" and indulge in a prolonged song-period with maxima in April and June, and normally a second brood is reared with the female largely responsible for care of the young. The harsher life of the northern insular environment, on the other hand, makes more urgent calls on the male's activities; he tends to be monogamous, builds fewer nests, and has a shorter period of vigorous song, since he must assist the female to provide food for the young, which normally appear as a single brood. Armstrong (1953) has deduced that this integration of behaviour patterns has proceeded away from the "mainland" and towards the "northern insular" type in the St. Kilda Wren, but that the St. Kilda Wren represents "an extreme case" of the bleak habitat type, as he suggested, may be doubted. It would appear that this might be more truly applicable to the Fair Isle bird. The success of the St. Kilda Wren is in sharp contrast to the apparent poverty of the Fair Isle community, which has less than one-third the population density and occupies a habitat which is indeed austere by comparison. It should also be borne in mind that the behaviour of the St. Kilda Wren has been studied only in the Village area where numbers are comparatively low. Here in 1957 there was no evidence of polygamy, "cock's nests" were scarce, only 2 of the 9 pairs were double-brooded, the males took a large share in feeding the nestlings (Bagenal, 1958), and nesting was protracted—all features which confirm Armstrong's findings. Whether or not this fairly reflects the situation in the optimal cliff habitats has yet to be determined. The nature of the pair-bond, as Boyd (*in litt.*) suggests, may be density-dependent, and we need to know more about the pattern of breeding in places like Carn Mor and the island of Dun.

Such knowledge would contribute towards a better understanding of Armstrong's (1958) thesis that "latent in both types of Wren is the capacity to behave in some measure according to the pattern of the other extreme", while admitting the theoretical possibility that adaptation to one type or the other might advance beyond the possibility of reversion, even if this were strongly favoured by a shift to the other environment. Herein may lie the key to another of the observed differences between the St. Kilda and Fair Isle stocks. The St. Kilda Wren seems to have retained a greater plasticity of behaviour than the Fair Isle bird, perhaps because its food-preference is more catholic. At some time after the coming of man it sought the shelter of the Village and (in

years of high density) the surrounding inland slopes where there are sufficient cleits and screes to afford protection from the weather. Perhaps colonization of the Village was accomplished readily because no change in food-preference was involved, for we may assume that in the early mediaeval settlement there was always a large quantity of refuse and offal from the fowling industry to attract scatophagous flies and other insects. This association with the Village was not in any sense a reversion to an ancestral "garden" environment, so much as a translation from the optimal cliff-habitat to a basically-similar inland one affording the same facilities of food and shelter. The Wrens of Fair Isle, on the other hand, appear to have reached a point of no return so far as any latent re-adaptation to the ancestral "garden" environment is concerned, and, unlike other races, appear to have been unable to expand into an inland environment although the opportunities are there. The crofting area, with its small gardens, enclosures, middens and other "fertile" attributes, has remained untenanted, and the specialization of *fridariensis* would seem to have reached a stage where the Village environment is the bleakest one of all.

The fluctuation in the number of Wrens occupying the Village Glen of St. Kilda is positive evidence that the population of *hirtensis* is not stable. Almost certainly the same is true of *fridariensis*, and there is a probability that in this respect the two communities are out of phase. The factors most likely to influence the survival rate of island Wrens have been argued by Williamson (1953) and Armstrong (1953b, 1955): there was agreement that these were most likely to be climatic, but disagreement as to which kind of winter—a hard one with frost and snow, or a mild and open one with its accompanying gales—would adversely affect survival most. What neither author then fully appreciated was that the "northern insular" habitats can be so fundamentally different. It is clear that *fridariensis* may have access to sufficient food at all times in the unfrozen tidal zone during a severe winter, and yet be endangered in open seasons through lack of shelter from onshore gales buffeting the comparatively bare coast. Stout's (1952) observation of a noticeable influx of Wrens to the crofting area from the cliffs and shores during a severe January storm is significant in this respect, and we have seen that the cliffs and beaches exposed to the prevailing winds are sparsely tenanted even in the nesting-season. The opposite may be true for *hirtensis*, which has more effective protection among the great diversity of crags, boulders, cleits and so on, but may have its food supply seriously impaired by a cold spell.

Now that these islands are more accessible than heretofore, and that meteorological observations covering the whole year will be available at St. Kilda (as they are at Fair Isle) through the good offices of the Services, there is hope of some further progress in exploring these complex problems of behavioural change and periodic fluctuations in strength. The two races of Wren are well

worth critical study, especially as regards their food preferences, and it is hoped that the various points touched upon in this discussion will provide an incentive to further research into their breeding cycle, and to the continuance of comparative census studies in future years.

#### (5) ACKNOWLEDGEMENTS

The St. Kilda portion of this study was done whilst I was attached to the R.A.F. Task Force at Hirta as the official representative of the Nature Conservancy, who have leased the St. Kilda archipelago from the owners, the National Trust for Scotland. Most of the observations were made between the arrival of the Advance Party in mid-April and my departure two months later for a short spell of field-work at Fair Isle on behalf of the Fair Isle Bird Observatory Trust.

I am very grateful to Drs. W. J. Eggeling and J. Morton Boyd, both of the Nature Conservancy (Scotland), and to Mr. I. J. Ferguson-Lees, for much invaluable criticism and advice in the preparation of this paper. I am also indebted to the Rev. E. A. Armstrong for his detailed and most helpful comments on the original draft, but he has asked me to make it clear that he is not necessarily in agreement with some of the points I have made.

#### (6) SUMMARY

1. The status of the St. Kilda Wren (*Troglodytes t. hirtensis*) and the Fair Isle Wren (*Troglodytes t. fridariensis*) was investigated by census of dawn-singing males in the spring of 1957, and an analysis and comparison of their respective adaptations to an insular environment are attempted.

2. The St. Kilda population is believed to have been not less than 230 pairs, with 116 pairs on Hirta, where 85% inhabit the cliffs and the remainder the deserted Village and other inland sites.

3. The coastal distribution is not uniform, there being areas of concentration showing marked association with colonies of the Puffin (*Fratercula arctica*), where there is abundant shelter and the main food is probably scatophagous and other terrestrial insects largely dependent upon animal remains.

4. The inadequacy of previous censuses of the Village area is discussed, and it is suggested that a recent recession may have taken place in this region, which is more sparsely inhabited than the optimal cliff habitats. Periodic changes in numbers in Village and Glen almost certainly reflect fluctuations in the population as a whole.

5. Comparison of densities in the Village and optimal cliff habitats suggests a territory-size of about 10,000 square yards at high density, against a maximum of about 19,000 square yards in marginal areas.

6. Nest-building and incubation are spread over a long period (May-July) and only 2 out of 9 pairs in the Village were double-brooded.

7. The Fair Isle population did not exceed 50 pairs in 1957, confined to the coast. There is no marked correlation with

puffinries, and the favourite habitat is provided by narrow inlets or geos with small beaches having wrack and tidal debris where the Wrens can feed. Birds are scarce on coasts exposed to the prevailing winds.

8. The divergence in habitat selection between the St. Kilda and Fair Isle communities may be correlated with different food preferences. The pattern of breeding in the Village Wrens confirms Armstrong's findings that *hirtensis* accords with the generally monogamous, single-brooded "bleak habitat" type (of which *fridariensis* seems likely to be the extreme case in Britain), but there is as yet no data concerning breeding behaviour in the optimal cliff habitats.

9. It is possible that a more generalized food-preference has enabled *hirtensis* to colonize the Village environment, whereas in *fridariensis* adaptations to a more specialized food-spectrum may have carried this race beyond the point where re-colonization of the ancestral "garden" habitat of the fertile crofting area is possible.

10. Further research into food-preference and breeding behaviour, coupled with comparative census work and correlation of the results with climatic data, are needed to throw further light on the adaptations of the two races and the nature of the population fluctuations.

#### (7) REFERENCES

- ARMSTRONG, E. A. (1952): "The behaviour and breeding biology of the Shetland Wren". *Ibis*, 94: 220-242.
- (1953): "The history, behaviour and breeding-biology of the St. Kilda Wren". *Auk*, 70: 127-150.
- (1953b): "Island wrens: conditions influencing subspeciation and survival". *Brit. Birds*, xlv: 418-420.
- (1955): *The Wren*. London. pp. viii + 312.
- (1956): "Territory in the Wren *Troglodytes troglodytes*". *Ibis*, 98: 430-437.
- (1958): "Notes on the Wren in the Aran Islands, Ireland". *Brit. Birds*, li: 29-35.
- ATKINSON, R. (1947): "Studies of some species rarely photographed. VI—The St. Kilda Wren". *Brit. Birds*, xl: 145, plates 12-15.
- (1949): *Island Going*. London. p. 384.
- BAGENAL, T. B. (1953): "The birds on St. Kilda, 1952". *Scot. Nat.*, 65: 19-23.
- (1958): "The feeding of nestling St. Kilda Wrens". *Bird Study*, 5: 83-87.
- BARRINGTON, R. M. (1884): "The St. Kilda Wren". *Zool.*, (3) 8: 383-385.
- BOYD, J. M. (1954): "The St. Kilda Wren in Village area, Hirta, in 1952". *Scot. Nat.*, 66: 47-48.
- , MUNNS, D. J. and WHITEHOUSE, A. A. K. (1956): "The birds of St. Kilda, May 1955". *Scot. Nat.*, 68: 14-22.
- , TEWNION, A. and WALLACE, D. I. M. (1957): "The birds of St. Kilda, midsummer 1956". *Scot. Nat.*, 69: 94-112.
- CLARKE, W. E. (1912): *Studies in Bird Migration*. Edinburgh, Vol. 2.
- (1915): "The Wren of St. Kilda: its status, plumages and habits". *Scot. Nat.*, (1915): 291-296.
- COCKBURN, A. M. (1935): "The geology of St. Kilda". *Trans. Roy. Soc. Edinb.*, 58 (21): 511-548.
- CRAW, H. A. (1951): "An expedition to Foula". *Bull. F.I.B.O.*, no. 3: 17-22.
- DIXON, C. (1885): "The ornithology of St. Kilda". "Further notes on the ornithology of St. Kilda". *Ibis*, (5) 3: 69-97, 358-362.



- DRESSER, H. E. (1886): "On the Wren of St. Kilda". *Ibis*, (5) 4: 43-45.
- ELLIOTT, J. S. (1895): "Observations on the fauna of St. Kilda". *Zool.*, (3) 19: 281-286.
- FISHER, J. (1948a): "St. Kilda, 1947". *Bull. B.O.C.*, 68: 66-71.
- (1948b): "St. Kilda—a natural experiment". *New Nat. J.*, 91-108.
- HARRISSON, T. H. and BUCHAN, J. S. (1934): "A field study of the St. Kilda Wren, *Troglodytes t. hirtensis*, with especial reference to its numbers, territory and food-habits". *J. Anim. Ecol.*, 3: 133-145.
- and ——— (1936): "Further notes on a field-study of the St. Kilda Wren (*Troglodytes t. hirtensis*, Seeb.) with especial reference to its nest-habits and song". *Scot. Nat.* (1936), 9-21.
- and LACK, D. (1934): "The breeding birds of St. Kilda". *Scot. Nat.*, (1934): 59-69.
- KEARTON, R. (1899): *With Nature and a Camera*. London.
- KENDEIGH, S. C. (1941): "Territorial and mating behaviour of the House Wren". *Ill. Biol. Monagr.*, 18: 1-120.
- MACAULAY, K. (1764): *The History of St. Kilda, etc.* London.
- MARTIN, M. (1698): *A Late Voyage to St. Kilda, etc.* London.
- MATHIESON, J., assisted by COCKBURN, A. M. (1928): *Map of St. Kilda or Hirta and adjacent islands and stacs (Inverness-shire)*. (Ordnance Survey, London.)
- MAYR, E. (1946): "History of the North American bird fauna". *Wilson Bull.*, 58: 3-41.
- NEWTON, A. (1902): *Ootheca Wolleyana*. London, Pt. II.
- NICHOLSON, E. M. and FISHER, J. (1940): "A bird census of St. Kilda in 1939". *Brit. Birds*, xxxiv: 29-35.
- PETCH, C. F. (1933): "The vegetation of St. Kilda". *J. Ecol.*, 21: 92-100.
- POORE, M. E. D. and ROBERTSON, V. C. (1949): "The vegetation of St. Kilda in 1948". *J. Ecol.*, 37: 82-99.
- SEEBOHM, H. (1884): "On a new species of British wren". *Zool.*, (3) 8: 333-335.
- STOUT, J. (1952): "The 'great gale' at Fair Isle, January 15th 1952". *Bull. F.I.B.O.*, no. 6: 26-27.
- WILLIAMSON, K. (1951): "The Wrens of Fair Isle". *Ibis*, 93: 599-601.
- (1953): "Notes on island Wrens". *Brit. Birds*, xlvi: 231-232 and 420.
- (1958): "The menace of the gulls at St. Kilda". *Bird Notes*, 28: 330-334.
- WITHERBY, H. F. *et al.* (1938): *The Handbook of British Birds*. London, Vol. I.

## PHOTOGRAPHIC STUDIES OF SOME LESS FAMILIAR BIRDS

### XCII. LITTLE SHEARWATER

Photographs and text by John Warham  
(Plates 64-67)

The Little, Allied or Dusky Shearwater (*Procellaria baroli* = *Puffinus assimilis*) is a small black and white shearwater whose oceanic distribution lies mainly in cold water south of the Equator. The breeding colonies at the Azores, Salvages, Canaries, Madeira and Cape Verde Islands are the only ones in the Northern Hemisphere. Bourne (1957) suggests that these North Atlantic colonies are relicts, the birds having entered the area from the south in the Pleistocene following a deterioration in climate. In recent geological times the climate has ameliorated and these northern races of the Little Shearwater, together with races of

the Frigate Petrel (*Pelagodroma marina*) and the Soft-plumaged Petrel (*Pterodroma mollis*), have become isolated north of the Equator.

Although the birds disperse from their breeding stations after rearing young, none of the races seems to undergo any extensive movement and there is no migration such as occurs with birds like the Great and Sooty Shearwaters (*P. gravis* and *P. grisea*). This sedentary tendency presumably accounts for the number of races that have been differentiated, two of which, the Madeiran (*P. b. baroli*) and the Cape Verde (*P. b. boydi*), are on the British list. In the Indian and Southern Oceans the bird breeds off the Western Australian coast; in the Pacific on Lord Howe, Norfolk and Chatham Islands, and in northern New Zealand; and in the South Atlantic there are breeding stations on Tristan da Cunha and Gough Island.

At all these colonies, except those on the Canary Islands, this bird is a winter breeder. Thus in the Northern Hemisphere the eggs appear around February and in the Southern they are laid in July. At the Canaries there are apparently two breeding populations, one which nests in the summer and the other in the winter. Bourne points out that this aberrant summer breeding population occurs only on the Canary Islands where the summer breeding Manx Shearwater (*P. puffinus*), a possible food competitor, is absent.

The Little Shearwater is very like a smaller edition of the more familiar Manx Shearwater, being wholly black above and white below (plate 64). It is about 11 inches long—some 3 inches shorter than the latter bird. The beak is greyish-black and the legs and webs light blue. As Serventy and Whittell (1948) point out, the dividing line between the black of the head and the white of the cheeks passes through the eye in this species (plate 66). With the rather similar Fluttering Shearwater (*P. gavia*) and the Manx Shearwater this line comes below the eye. The black feathers of the Little Shearwater's upper-parts do not carry a brown cast as do those in the similar-sized Audubon's Shearwater (*P. lherminieri*), which has flesh-coloured or whitish legs and yellowish webs. In the Madeiran race the under tail-coverts are white, but in the Cape Verde race (regarded by some as a race of Audubon's Shearwater) the whole underside of the tail appears black.

The mode of flight (plate 67 lower) differs from that of the larger shearwaters in being much more fluttering, the wings being beaten very rapidly, but under stormy conditions the bird may also bank and glide like the bigger species. The food of the Western Australian race (*P. b. tumeyi*) consists of small squids, but little fish like sardines and anchovies are also taken. Similar food has been reported from the stomachs of specimens taken at the Cape Verde Islands.

The following breeding notes refer to the Western Australian

race which nests from the Arolhos Islands southwards and east to islands in the Recherche Archipelago. The observations were made during visits to Eclipse Island at about  $35^{\circ}10'S$ .  $117^{\circ}55'E$ . from 9th to 24th July and 9th to 24th September 1954 and from 24th January to 11th February 1956.

On the breeding grounds this small petrel behaves very much like other members of the genus. The bird shuns the light and does not fly overland until nightfall, although there are no natural avian predators like the gulls which are supposed to be responsible for the nocturnal habits of Manx Shearwaters on the Welsh islands.

Incoming birds travel quite fast. Flying into the wind, they usually make several trial runs before fluttering their wings through a small amplitude, stalling, and dropping to the ground. Many birds land close to the entrances to their nests. Some may alight on top of the tea-trees (*Leptospermum*) growing above some of the nesting places. Although these shearwaters walk awkwardly, departure is usually easy on Eclipse Island since the winter is the stormy season, while the steep slopes also facilitate take-off. Even on dark nights the birds seem to find little difficulty in locating their nests and inward flights are not accompanied by much calling. About an hour suffices to bring in the bulk of the breeding birds.

These Little Shearwaters are noisiest at the beginning of the season: in January, when they first begin to return in force, there is a lot of calling both from the ground and from the sky, particularly on dark nights. Later, when eggs or chicks are in the nest, there may be very little sound.

The Eclipse Island Little Shearwaters nest in burrows tunnelled into sidings clad with pigface (*Carpobrotus*) or beneath rocks on the hillsides. Tunnels may be straight or devious and nesting chambers are often impossible to reach by hand. The situations chosen seem to correspond pretty well with those used by the Tristan race (*P. b. elegans*) as described by Elliott (1957). Repeated strokes of one foot and then the other are used to throw out the soil loosened by the bird's bill. A single white egg is laid and this is incubated by both sexes, the change-over occurring about every two days (Glauert, 1946). Hatching occurs about the end of August after an incubation period of 52-58 days. The egg-shell remains in the nest and is trampled underfoot.

The downy chick (plates 65 and 66) is grey on the back, light grey on the belly and almost white on the throat. The beak is dark grey, as are the toes and the sides of the legs; the "knees", the fronts of the legs and the webs are grey-blue. When a few days old the chick is abandoned during the daytime by the adult and from then on is no longer brooded. During its first few weeks it is fed quite often, almost nightly (Warham, 1955) or about every other night (Glauert, 1946). The latter author gives the fledging period as 70-75 days and, as with other shearwaters, the young emerge from their burrows after dark to sit outside and exercise their wings for some time before their final departure. The chicks

are apparently deserted by the old birds 8-11 days before they take to the water.

Since the chicks do not leave until late October and early November, the island is free of birds for only two months each year. Similarly it has been noted that the Tristan and Cape Verde birds may visit nesting cavities throughout the year. This extensive season is perhaps a reflection of the bird's non-migratory regime which allows a more leisurely breeding cycle, rather than of a shortage of nest sites as Fisher and Lockley (1954, p. 183) tentatively suggest. The Eclipse Island colony is, in fact, not particularly large, the other species of petrels breeding there use bigger holes, and there are plenty of cavities apparently suitable for the Little Shearwater that are not utilized. The length of the sojourn of these non-migratory birds on Eclipse Island may be compared with the  $6\frac{1}{2}$ -7 months needed between the arrival of the adults and departure of chicks in the case of the migratory Pale-footed Shearwater (*P. carneipes*) on the same island and of the Short-tailed Shearwater (*P. tenuirostris*) at the Bass Strait rookeries. The egg-laying period in these migratory species is likewise contracted, whereas Little Shearwaters eggs have been found at Australian nesting sites as early as 21st June and as late as September.

From January onwards there are the usual disputes over nesting sites and quite fierce fights may take place, to the accompaniment of raucous growls. Similar cries are also given by birds that are handled for ringing, although some may be quite silent. By the end of January a good many pairs are already remaining inside burrows by day, although egg-laying is at least 6 months ahead.

Courtship behaviour, which seems to occur right through the breeding season and takes place both inside and outside the burrows, consists of the usual billing, mutual preening of heads and necks, and duetting. In the last the "song" is given by both birds with somewhat down-turned bills, inflated throats and arched napes (plate 64). Reddish oil may ooze from the nostrils of courting birds.

It seems that there is a good deal of variation in the voices of the various races of this bird. None of the published descriptions of other authors—sharp "preep, preep" (Elliott, 1913), "karki, karrou" (Alexander, 1898), "ha-kwa-kwa" (Buller, 1888)—tally with the sounds made by the Eclipse Island birds. Nor could their calls be described as a high-pitched version of those of the Manx Shearwater, as Lockley found for the Madeiran race (Lockley, 1952). All the Little Shearwater songs noted by the present writer, whether from ground or air, were similar. They were of the same asthmatical, sobbing pattern as used by other members of the genus and based on the phrase "wah, i-wah-i-wah-oo", the emphasis being on the first syllable. This song was repeated 2 or 3 times and trailed off, as it began, in an incoherent splutter. The "wahs" were given as the breath was expelled, the rest on the

intake. Like other shearwaters, this species will sing its song during the daytime, apparently being incited to do so by the vibrations set up by human feet. Groups of displaying birds, such as occur on the Cape Verde Islands (Bourne, 1955), were not noted, but threesomes were fairly common.

The behaviour of birds with chicks was watched at burrows fitted with false roofs, a method which was first used in 1948 with the Manx Shearwaters on Skomer Island and which has since been found effective with four Australian members of the genus. A red light was used to illuminate the nesting chamber.

The young chick's activities are restricted to preening, beating and stretching its wing stubs and reaching out to pick up grasses, feathers and the like to tuck into the nest all round it. The young bird is visited by both parents, but usually only one comes in on any particular night. The chick is fed soon after the adult's arrival, a process that is initiated by the nestling's cheeping continually (a series of attractive liquid chirrup indistinguishable from the calls of any other *Procellaria* chick at this stage) and diving its beak at the adult's head. The latter may also preen the chick's head and back at this stage (plate 66 upper). This leads to fencing with bills (plate 66 lower), the young still calling vigorously. The old bird then opens its beak wide, the chick inserts its own at an oblique angle and the two remain crossed as the food is transferred (plate 65). The chick is now silent but may beat its wings during the five seconds or so in which the food is being transferred. The chick's bill lies on top of the old bird's tongue so that food is diverted from the one bill into the other. The chick then withdraws, both swallow and after a slight pause the cycle is repeated. Feeding is kept up for 15-20 minutes in this intermittent fashion.

After the meal both chick and old bird generally fall asleep and a tour of occupied sites some hours after the incoming birds' arrival reveals many adults resting or sleeping in the tunnels, or near the entrances, with their heads tucked into their scapulars. The outward movement back to sea takes place well before dawn.

#### REFERENCES

- ALEXANDER, B. (1898): "An ornithological expedition to the Cape Verde Islands". *Ibis*, (7) 4: 74-118, 277-285.
- BOURNE, W. R. P. (1955): "The birds of the Cape Verde Islands". *Ibis*, 97: 508-556.
- (1957): "Additional notes on the birds of the Cape Verde Islands, with particular reference to *Bulweria mollis* and *Fregata magnificens*". *Ibis*, 99: 182-190.
- BULLER, W. L. (1888): *A History of the Birds of New Zealand*. London. 2nd edition.
- ELLIOTT, H. F. I. (1957): "A contribution to the ornithology of the Tristan da Cunha group". *Ibis*, 99: 545-586.
- FISHER, J., and LOCKLEY, R. M. (1954): *Sea-Birds*. London.
- GLAUERT, L. (1946): "The Little Shearwater's Year". *Emu*, 46: 187-192.
- LOCKLEY, R. M. (1952): "Notes on the birds of the Berlengas (Portugal), the Desertas and Baixo (Madeira) and the Salvages". *Ibis*, 94: 144-157.
- SERVENTY, D. L., and WHITTELL, H. M. (1948): *A Handbook of the Birds of Western Australia*. Perth.
- WARHAM, J. (1955): "Observations on the Little Shearwater at the nest". *West. Australian Nat.*, 5: 31-39.

## NOTES

**Killdeer in Cornwall.**—On 26th December 1957, a bird was accidentally shot during a snipe shoot in a small marsh on the edge of Trembleath Wood, St. Columb Major, near Newquay, Cornwall. It was sent to the British Museum (Natural History) where it was found to be a Killdeer of the North American race (*Charadrius vociferus vociferus*). It was an adult female, the ovary measuring 7 mm. long  $\times$  4 mm. at its widest, and was in good condition with large deposits of body fat.

There have been only thirteen previous records of this species in Great Britain and Ireland, the last being in 1939. This specimen (B.M. Reg. No. 1958.1.1) is only the second from Great Britain to be added to the collections of the British Museum (Natural History). I am indebted to Colonel E. N. Wilyams for sending me the specimen and for giving me permission to publish this note.

R. W. SIMS

[*The 27th Annual Report (1957) of the Cornwall Bird-Watching and Preservation Society* (p. 40) gives details of a Killdeer seen on St. Agnes, Scilly Isles, on 12th December 1957, by Miss H. M. Quick and Mr. Lewis Hicks: it is thought probable that this was the same bird.—EDS.]

**The leg colour of the Kittiwake.**—The legs and feet of the Kittiwake (*Rissa tridactyla*) are invariably described as being dark in colour: black, brown, dark reddish-brown, or, as in *The Handbook of British Birds*, brown-black in the adult and brown in the juvenile to second winter plumages. This is certainly the impression given in the field by the majority of birds.

On 11th July 1954, however, with Austin Barton, I had excellent views of a bird at St. Bees Head, Cumberland, which had vivid chrome-yellow legs and feet. As it wheeled about the cliff face near its nest it repeatedly approached to within a few yards when the colour was most striking, as indeed it was at greater distances. The same bird was seen by F. H. Waters on 2nd August 1954.

At the Bass Rock, East Lothian, Andrew T. Macmillan, who has kindly allowed me to include his observations in this note, saw a bird at the nest on 23rd July 1955, which had orange legs and feet. He compares the colour to that of the legs of the drake Mallard (*Anas platyrhynchos*) on plate 83 (top left) of *The Handbook*, vol. III. Again on 19th July 1958 at the same place he saw three such birds, though two of these were duller than the third.

Looking for further examples, I have been able in the last four years to examine 26 dead Kittiwakes on the tideline of the Cumberland Solway, two of which were in juvenile plumage. Eight adults and one juvenile showed some yellow. In the cases of the adults it was perhaps only on the undersides of the toes or, if better developed, on the outside of the tarsus and on the toes (in these latter examples the legs were generally paler and the webs

showed a yellow tinge against the light). The juvenile, on the other hand, had completely pale legs and feet: a washed-out yellow with a trace of dark pigment along the underside of the tarsus and along the outside edges of the outer toes; its claws were dark.

The possibility of a marked colour change after death, due to exposure to sea and sun, must be borne in mind but apart from a slight dulling of the colour, I have not found much change in other species—provided, as in the examples used here, the corpses were reasonably fresh.

At St. Bees Head, which is the only Kittiwake colony close at hand, the nests are inaccessible unless one attempts a hazardous climb which I have not repeated since 1954. The birds there are best viewed from below, when it is possible to see their feet fully extended as they brake before alighting. In this way I examined 100 birds on 27th July 1958 and was able to detect some trace of yellow on 12. Under ideal conditions and with a closer approach I am sure the figure would be higher.

Tentatively, therefore, one concludes that there is a good deal of variation in the leg colour of both adult and juvenile Kittiwakes; that the dark masking pigment is commonly partially suppressed, revealing a varying amount of yellow; and that exceptionally this pigment may be completely absent, when the legs and feet appear pale yellow in juveniles and deep yellow or orange in adults.

RALPH STOKOE

[We should be glad to receive any other records of Kittiwakes with light-coloured legs.—EDS.]

**Lesser Black-backed and Herring Gulls nesting on a factory-roof inland in Glamorgan.**—An unusual inland breeding colony of Lesser Black-backed Gulls (*Larus fuscus*) and Herring Gulls (*L. argentatus*) came to light on 24th May 1958 through, unfortunately, a fatal accident to a boy who had climbed up to, and fallen from, the factory-roof upon which it is.

The factory, a single-storey building with a "north-light" type roof, belongs to Messrs. Lines Bros. (South Wales) Ltd. and is situated at the bottom of the rather steep-sided valley of the River Taff in Merthyr Tydfil, Glamorgan; it was erected about 30 years ago and in 1944 two adjacent large bays were added, each with a single-span ridge-roof of asbestos-cement sheeting, the total roof area being now upwards of five acres. The surrounding area, part of the N.W. side of the town, is built-up and includes other modern factories built upon the site of and amongst the ruins of the old iron-works and the slag-tips they created.

Information obtained from Mr. Howell and Mr. Edge, the latter of whom has been at the factory for the past 20 years, is that the gulls did not nest there before the extension was erected in 1944, but began to do so on the new roof, in quite small numbers, soon afterwards, probably in 1945 or 1946, since when they have increased gradually over the years.

The site was visited by Messrs. John Griffiths, David Griffin and J. D. Rae Vernon from 26th May 1958 onwards, and on 12th June by the writer who also took photographs (see plate 68). The combined observations showed that approximately 120 adults were present on the roof, in the proportions of *ca.* 70 Lesser Black-backs to *ca.* 50 Herring Gulls; the maximum count was 122 at 4.30 p.m. on 12th June, at a time when most birds were quiescent and settled. Of the visible nests on that day, 26 were occupied by Lesser Black-backs and 19 by Herring Gulls, with five unoccupied. It is possible there may have been a very few more, but most of the roof could be seen from various points on the adjacent high ground. Whilst most nests were built against the ventilators projecting from the roof, some (as can be seen in the photograph) were on the open, sloping roof. A heavy rainstorm will apparently dislodge the latter nests, which are then washed down into the gutters, choking them.

One Lesser Black-backed chick was seen on 8th June and there were two at separate nests on the 12th; eight chicks at six nests were seen on 24th June. On 15th July a number of the gulls were still, apparently, incubating; and on 23rd August, from one viewpoint only, a dozen or more near-fledged juveniles were visible on the roof.

This factory is 600 feet above sea level,  $21\frac{1}{2}$  miles from the nearest point on the coast and 23 miles from the nearest breeding-place of either species. There are probably *ca.* 1,000 pairs of Herring Gulls nesting each year on the cliffs of the Glamorgan coastline but less than 20 pairs of Lesser Black-backs, although there are over 600 pairs of the latter (with *ca.* 3,500 pairs of Herring Gulls) on Steep Holm, in the Bristol Channel, 30 miles distant.

Inland breeding of these two species in South Wales has not occurred elsewhere, so far as the writer is aware, except at Tregaron Bog, in Cardiganshire (where there was formerly a long-established colony of Lesser Black-backs, from which the birds were finally driven away about the middle 1930's), and at a Breconshire reservoir, ten miles north-west of Merthyr Tydfil (where an isolated pair of Lesser Black-backs nested about 30 years ago).

In the 1920's and earlier, Lesser Black-backs were constantly to be seen on the River Wye at Builth Wells, Breconshire, probably due to the proximity (22 miles) of the then Tregaron Bog colony, but were seldom met with in other inland districts. For the past ten years or more, however, they have been increasingly frequenting the Rivers Usk and Wye in Breconshire and Radnorshire, 40 miles from the sea, and are to be seen there almost daily in summer, though Herring Gulls are infrequent.

Both species, however, have long come up the Rivers Taff and Rhymney, in the industrial valleys of Glamorgan and Monmouthshire, attracted to slaughter-house offal dumps and refuse tips.



Thirty years ago, even here, the Lesser Black-back was more frequently seen in summer than the Herring Gull, although at that period it was very rarely recorded in S. Wales between October and March; today it is commonplace throughout the winter.

For the past decade, then, in this area on the Glamorgan-Monmouthshire-Breconshire borders, both species have been much more in evidence and for several years there has been an autumn-to-spring roost of *ca.* 1,000 birds, with Herring Gulls predominating, on a reservoir five miles north of Merthyr Tydfil, but it is extraordinary that this breeding colony has gone so long unnoticed by an ornithologist: it has even been in full view from the road Aberdare-Merthyr Tydfil.

*The Handbook* (1941) quoted the Herring Gull's breeding "once on a house-roof in Devon"; and since then the colonial nesting of this species on roof-tops in Dover, Kent, has been described (*antea*, vol. xlviii, pp. 88-9). Further, Ralph Chislett (*Yorkshire Birds*, 1953) recorded that in 1947 some Herring Gulls nested on the roofs of houses and shops at Whitby, at Robin Hood's Bay and at Colburn Nab, Staithes, and stated that there had been similar occurrences in other years; *The Times* recently (3rd and 10th June 1958) also contained references to this species nesting on the roofs, etc., of houses in the village of Staithes. However, it will be noted that these records all refer to roofs in coastal districts.

H. MORREY SALMON

**Magpie's rapid replacement of dead mate.**—C. D. T. Minton's note (*antea*, p. 309) describing two recent instances of a Magpie (*Pica pica*) rapidly replacing its dead mate (once within seven hours) is of considerable interest. However, he stated that this had not previously been recorded as occurring in the Magpie and, though this is true for the present century, there are several instances mentioned in the earlier literature.

W. T. Greene (1885) wrote of a female which was shot from a nest with newly-hatched young. Another mate was procured by the male within twenty-four hours, the young were raised and she subsequently brought off a brood of her own.

The record cited by MacGillivray (1837) has frequently been repeated in later works. It concerned three presumed females which were shot in succession from the same nest. Replacement was always within two to three days. He also instanced the case of six Magpies successively shot from the same clutch.

Linsdale (1937) summarized several records of similar behaviour notably Selby (1833), Thompson (1840) and Raspail (1901). The last author reported three occasions on which one of a pair (in two cases the male) was shot during the latter stages of nest-building; each time replacement was within twenty-four hours. It was further stated by Raspail that the replacement was always preceded by a gathering of all the Magpies in the vicinity. It would be of interest to know if there are any more recent

observations confirming the latter behaviour, which might throw some light on the nature of the spring gatherings of Magpies, the purpose of which is still imperfectly understood. G. R. SHANNON

## REFERENCES

- GREENE, W. T. (1885): *Birds I Have Kept in Years Gone By*. London. p. 79.  
 LINSDALE, J. M. (1937): *The Natural History of Magpies*. Cooper Orn. Cl., Pacific Coast Avifauna, No. 25. p. 74.  
 MACGILLIVRAY, W. (1837): *A History of British Birds, indigenous and migratory*. London. p. 570.  
 RASPAIL, X. (1901): "Cérémonie de secondes nocés chez les garruliens (*Pica caudata* et *Garrulus glandarius*)". *Bull. Soc. Zool. France*, 26: 104-109.  
 SELBY, P. J. (1833): *Illustrations of British Ornithology*, vol. I. Edinburgh. pp. 36 and 335.  
 THOMPSON, W. (1849): *The Natural History of Ireland*. vol. I. London. pp. 20 and 434.

## LETTERS

## EGGS DISAPPEARING FROM PEREGRINE EYRIES

SIRS,—The paper by Dr. D. A. Ratcliffe on "Broken eggs in Peregrine eyries" (*antea*, pp. 23-29) has greatly interested me, as it seems to throw considerable light on past happenings here in Montreal, Canada. For thirteen years a pair of Peregrines (*Falco peregrinus*) claimed the Sun Life Assurance Company's building for an eyrie and during this period we were frequently mystified by the disappearance of eggs.

The birds were on the building every summer for 17 years from 1936, and from the time that they found a suitable scrape—from 1940 to 1952 inclusive—eggs were laid every year. During that period 50 eggs were laid, but only 26 hatched. Of the 24 that failed to hatch, 9 were fertile in various stages of development, 4 were addled, and 11 mysteriously disappeared. The first surprise came in 1942, when two eggs unaccountably vanished from a clutch of four. Nothing strange happened after that until 1948, in which year I was out of town all summer: there was no brood then and only one egg was seen and photographed in the scrape by a friend.

The following year, 1949, small chips of egg-shell were seen in the scrape before any eggs were recorded. Then on 11th April the female Peregrine was seen in the act of eating an egg which must have been newly laid. On 14th April another egg was laid and by the 20th there were four in the eyrie. Soon afterwards, however, first one and then another disappeared until all four had gone, though the female continued for several days to sit on the empty scrape. If we place the responsibility on the bird herself, then not only was the clutch of four eaten that year but also the egg she was seen devouring and possibly a sixth one, judging from the evidence of the chips of shell.

In 1950 the usual clutch of four was laid, but one disappeared and only three hatched. In 1951 there was a clutch of four eggs a little earlier than usual: very soon three disappeared, one by one, and the chick in the fourth died in the shell when almost ready to

hatch. In 1952, the final year, one egg disappeared and the other three hatched.

On only one occasion did the clutch exceed 4 eggs and that was in 1941 when there were five, though only three hatched. It is interesting to note, too, that with one exception the eggs did not begin to disappear until the clutch was complete (the exception being in 1949, when the bird was seen eating an egg before any had been recorded in the scrape).

In the eyries visited by Dr. Ratcliffe, broken shells were frequently, if not always, seen after eggs disappeared. On the other hand, except for the few pieces of egg-shell in 1949, not a fragment was ever discovered after eggs vanished from the Sun Life building, not even from the shell the Peregrine was seen eating. This fact puzzled me greatly, but, taking into consideration Dr. Ratcliffe's observations and tentative conclusions, I now have little doubt that the loss was due to the birds themselves. The ledge was practically immune from human interference and in any case the manner of the disappearances excluded the idea of egg-collecting. Rats were unknown on the building, and crows or other large birds were never to my knowledge seen to alight there during the years the Peregrines were in occupation.

In his paper Dr. Ratcliffe comments on the apparent unlikelihood of any connection between egg-eating and a shortage of food, and the latter could hardly have been the cause at any time in Montreal: there was always a superabundance of feral pigeons (*Columba* spp.) and Starlings (*Sturnus vulgaris*) in the city.

Incidentally, during the whole period of 17 years in which Peregrines resided on the Sun Life building the female was the same individual, but in that time she definitely had three different mates. We know also that the first male was actually killed in a fight.

G. HARPER HALL

[We showed Mr. Hall's interesting letter to Dr. D. A. Ratcliffe who has commented as follows: "This sounds like just the sort of thing which I have encountered, except that chips of shell were found only once. However, Mr. Hall states that even when the Peregrine was seen eating its egg no fragments were discovered afterwards, and if a bird consumed the whole egg while the shell membranes were still moist there would not be any remains. It is only when a piece of shell is left, and becomes trodden about the scrape, that any signs are visible. The fragments of shell in any one of the eyries I saw would never have represented (if pieced together) more than a portion of a single egg. Thus the Montreal evidence would seem to justify a similar conclusion to that reached in my paper: again there is certain proof in only one case, but the available facts do point to egg-eating as the usual cause of disappearance."—Eds.]

#### IMPRESSIONS LEFT BY BIRDS STRIKING GLASS WINDOWS

SIRS,—You will recall that, immediately after the publication

of the photographs and letter in *British Birds* (vol. L, plate 56 and p. 393), I wrote to you that, in my opinion, the wing-pattern on the glass of the Birmingham bird made it quite impossible for it to have been caused by an owl (?*Strix* sp.), as was suggested, and that I considered it was made by a pigeon (*Columba* sp.).

The only owl with a wing-formula that could conceivably correspond to that shown in the photograph is the Barn Owl (*Tyto alba*), but I have since picked up at a roadside a freshly killed Barn Owl. The skin of this bird, through the courtesy of the Keeper of Zoology, National Museum of Wales, has been mounted as nearly as possible in the attitude of the impression on the window, but I cannot make the wing-patterns agree at all. I am therefore more than ever confident (apart from the unlikelihood of an owl flying into a window at 11 o'clock in the morning) that this impression was made by a pigeon.

I have personally known two previous cases of similar impressions, both in the Cardiff area: one, probably of a feral domestic pigeon, which I photographed in August 1919, and the second, more recently, on 7th September 1953, of a juvenile Woodpigeon (*Columba palumbus*) which killed itself by flying into a window, probably trying to get away from a Sparrowhawk (*Accipiter nisus*).

H. MORREY SALMON

SIRS,—I should like to return to the interesting subject of "Impressions left by birds striking glass windows" (*antea*, vol. L, p. 393 and plate 56). Of the two photographs reproduced there, one is stated to be the impression of a pigeon (*Columba* sp.), and clearly is, while the other is described as perhaps being that of an owl. I believe, however, that this second excellent photograph concerns not an owl but another pigeon. The shape of the wing is exactly like that of the domestic pigeon (*C. livia*). It is true that owls (perhaps including the Barn Owl, *Tyto alba*) produce powder, but pigeons do so much better. An earlier reproduction in *British Birds* (vol. xlvi, plate 57), which was also published some years ago in the American magazine *Life*, showed the impression left by a pigeon on the wing-tip tank of an aircraft which had flown through a flock of these birds in Canada in November 1954. *Life* also reproduced, on another occasion, a large photograph of a pigeon-impression on the glass window of a house. Many years before these, however, in 1908, S. Schaub described such an impression (*Zool. Jb. Anat.*, vol. 25) which he attested as "*Turtur risoreus*" (= the Barbary Dove, *Streptopelia risoria*).

Further, with regard to Mr. E. J. M. Buxton's interesting note that accompanied the two photographs in question, may I suggest that the term "powder-feathers" and not "powder-down" should be used. As demonstrated in my dissertation in *Journal für Ornithologie* in 1927 (vol. 75, p. 100), when I quoted Schaub's record, powder-down does indeed represent the extreme condition of a powder-producing feather, but in a greater number of bird-groups—especially those by whose grey colouring it is disclosed—

there is also a strong formation of powder on the contour-feathers. Only such birds with a particularly heavy general covering of powder could mark their outlines in the astounding way that is shown in the reproduced pictures. Mr. Buxton is certainly right that only the larger species of birds produce abundant powder: among the Passerines the Campephagidae (cuckoo-shrikes) are the most striking example.

ERNST SCHUEZ

## RECENT REPORTS AND NEWS

By I. J. FERGUSON-LEES and KENNETH WILLIAMSON

**The items here are largely unchecked reports, and must not be regarded as authenticated records. They are selected, on the present writers' judgment alone, from sources generally found to be reliable. Observers' names are usually omitted for reasons of space and in case a report is subsequently rejected, and none of the items will be mentioned in our annual Index. Readers are asked to submit anything of interest as quickly as possible.**

Reports for September are still (mid-October) being added daily to the already unusually large accumulation on what was a remarkable month for migration (see *antea*, pp. 361-362) and in some cases essential preliminary enquiries have not yet been completed. We have therefore decided to delay our summary of the many unusual birds in this period until the November issue.

### THE 1958 BREEDING-SEASON IN GENERAL

Instead, now that the breeding-season is over, it seems an opportune moment to reflect on some of its features. Firstly, the persistent cold weather that began in early March and, with only one short break at the end of that month, continued until 18th April (*antea*, p. 203) resulted in one of the latest breeding-seasons of recent years as far as most of the resident species were concerned. A number of reports confirm this, but an excellent and typical example is provided by the dates of Great and Blue Tits (*Parus major* and *caeruleus*) at Wytham, Oxford: Dr. David Lack tells us that 1958 was the second latest season for those species in the twelve years of study there since 1957, the mean date of laying (first egg) being 5th May for the Blue Tit and the 6th for the Great. Only 1951, when the mean dates were 6th and 10th May respectively, was later (the mean date for these species at Oxford usually falls in the last week of April, occasionally in the first days of May).

In view of this, it is somewhat interesting to find that the summer-visitors which flooded into this country during 19th-26th April, after a considerable period of hold-up (*antea*, p. 206), were largely unaffected. A useful example of this is provided by Dr. Bruce Campbell's observations on Pied Flycatchers (*Muscicapa hypoleuca*) and Redstarts (*Phoenicurus phoenicurus*) in the Forest of Dean, Gloucestershire: there the mean dates of the first eggs of 67 clutches of the former and 10 of the latter were 10th and 8th May respectively, which are described as "early average" and

constitute a remarkable recovery from a late arrival. Similarly, it will be remembered that many Swifts (*Apus apus*) returned to this country surprisingly early in the fourth week of April (*antea*, p. 206): as a result, the earliest egg recorded in 11 years of study in the Museum Tower at Oxford was laid on 11th May (the previous earliest being on 17th May 1952); unfortunately, the subsequent cold weather caused many other individuals to delay and the mean date for this Swift population was not exceptional. Another remarkable example of the recovery by the summer-visitors concerns a pair of Reed Warblers (*Acrocephalus scirpaceus*) at Marbury Mere, Great Budworth, Cheshire: their nest with four eggs was found on 9th May, an extraordinarily early date for this species; two of these eggs had hatched by the 19th.

#### THE PROGRESS OF CERTAIN RARER SPECIES

It is possible now to refer briefly to certain of the rarer nesting species, and at the same time to comment on the status of one or two of the less common ones. Most people will know of the regrettable finish to the attempt by a pair of Ospreys (*Pandion haliaëtus*) to breed in Scotland in an eyrie which was first unsuccessfully occupied in 1955 (*antea*, vol. L, p. 148). Here on 11th May this year the first of two eggs was laid and on that day a collector climbed the tree and caused considerable disturbance; some three weeks later, "under cover of darkness", to quote a letter from Mr. Arthur Duncan and Lord Hurcomb in *The Times* of 13th June, "a person succeeded in reaching the tree in which the eyrie was situated and climbed up to it. For the two osprey eggs he substituted hen's eggs daubed with brown boot-polish. Being disturbed, the unknown intruder made his escape into cover near by. The two osprey eggs were recovered near the foot of the tree. They had been smashed and had either been dropped or thrown down. Both of these eggs were fertile". These facts speak for themselves. During the summer, single Ospreys were also reported in Caithness and Sutherland on 8th and 15th June respectively; much earlier there was one at Sandwich, Kent, on 5th April and then two at Benacre, Suffolk, in mid-April (*cf. antea*, p. 208). (August reports of Ospreys were given last month, p. 362, and we shall be referring to a number of September occurrences.)

Preliminary reports on the 1958 breeding-season of the Kite (*Milvus milvus*) in Wales show that 5 pairs each reared one young. Misfortune attended several other, normally successful, sites: for example, an incubating female died after accidentally breaking a wing, while in another case a branch broke and the nest fell. (A review of the status of the Kite in the British Isles was published in *British Birds*, vol. L, pp. 137-141.)

Collared Doves (*Streptopelia decaocto*) were proved to be breeding in three counties in 1958 and there is a strong possibility that a pair nested in a fourth. It will be remembered (*antea*, p. 40)

that by 1957 these birds had been found breeding in Norfolk (see also *antea*, vol. L, pp. 239-246), Kent, Morayshire and Lincolnshire. In Norfolk in 1958 it is probable that no more than four pairs spent the summer in the breeding-area; no nests were found, but several young were reared. In Kent a nestling fledged in a new locality and the pair in Morayshire, having remained through the winter with a third bird that was probably the youngster reared in 1957, brought up two broods of two young each. At the site in Lincolnshire, however, there was only the original male (*antea*, vol. xlvi, pp. 51-55) except on one day, 13th June, when four birds were seen displaying and fighting—to no avail, for after that date there was only the one bird again. On the other hand, there is some evidence that a pair reared one youngster in Essex, at a locality where a single bird spent the summer of 1957 and where up to six were seen last winter. Reports of Collared Doves outside the colonized counties have been very few—less than in 1957, in fact—and one is left with the general impression that the species made little or no progress during 1958.

A pair of Avocets nested in Kent, but at Havergate in Suffolk the main colony (of some 90 pairs this year) had a very poor season: altogether some 130 clutches of eggs were laid, but a combination of weather and other factors resulted in only about 31 young being reared to the flying stage. On the other hand, the impression at the moment is that Little Ringed Plovers (*Charadrius dubius*) have done well: insufficient figures are in as yet, but it may prove that the population reached a new peak in 1958. At the same time that other comparatively recent and successful colonists of the British Isles, the Black Redstart (*Phoenicurus ochruros*), seems also to have had a good season. Breeding has been reported in three places in the London area (Cripplegate, Potters' Bar, Croydon); in Gillingham, Rochester, Faversham, Gravesend and Dover, as well as three pairs on the cliffs between Folkestone and Dover (Kent); in Hastings (Sussex); in Lowestoft (Suffolk); in Yarmouth and Cromer (Norfolk); and in Nottingham (the first definite record there). In addition, a male was singing in Hereford in May, other singing males were present in Ipswich and Norwich right through the breeding-season, and at least one, probably two, appeared in Birmingham for the first time since 1953. One is attempted to link this increased breeding with the unusual passage of these birds in late March and early April (*antea*, p. 224). Indeed, R. S. R. Fitter tells us that once before, in 1942, a big spring influx was followed by nesting on a larger scale. He also informs us that the number of reports of breeding pairs had been declining for some years until 1958 (though this may partly have resulted from the regrettable fact that most bird-watchers now take less pains to check on this species than they did when it first became established during and after the war).

#### OTHER INTERESTING BREEDING RECORDS

In Ireland, where all forms of *Motacilla flava* are now little

more than rare passage migrants, three pairs of Yellow Wagtails (*M. f. flavissima*) bred successfully at a locality in Co. Antrim: here also a pair of Blue-headed Wagtails (*M. f. flava*) and 5 young wagtails were seen on 19th July, but there is no evidence to show this was a family party. However, a pair of Blue-headed Wagtails certainly raised a brood at Salthouse, in Norfolk, after an influx of these birds there at the end of April. This influx was referred to on page 206 of our May number where it was also mentioned that on 30th April a number of wagtails resembling the form known as Sykes's Wagtail (*M. f. beema*) had appeared at Beddington sewage farm, Surrey, where a group had nested in 1957. We do not wish to anticipate here the findings of the full paper on this subject which it is hoped to publish later, but it is of interest to say that in 1958 eight *beema*-type males were present during the breeding-season: one had a B.T.O. ring and was almost certainly one of those that had bred there in 1957; two others carried plain orange rings as well, indicating that they had been ringed as juveniles in the previous year.

A pair of Pintail (*Anas acuta*) again bred successfully at Breydon, Norfolk, and Gadwall (*Anas strepera*) reared 11 young at Chew Valley reservoir, Somerset—a first record for that county. At Chew, too, a Shelduck (*Tadorna tadorna*) with 10 ducklings less than a week old was seen on 19th June: this is the fourth year in succession that this species has bred at this inland locality (see *antea*, vol. xlix, p. 280); Shelduck also nested inland in the Fens as usual (*cf. antea*, vol. xlvi, pp. 362-363). Another interesting case of inland breeding was provided by a pair of Common Terns (*Sterna hirundo*) which attempted to nest on one of the Middlesex reservoirs: two eggs were found on 29th June, but these had unfortunately been destroyed by 5th July. Two out of 3 pairs of Common Terns in N. Staffordshire were more successful, rearing five young to the flying stage, but this inland area is not new.

Two pairs of Kittiwakes (*Rissa tridactyla*) nested on the ground on the N. Norfolk coast and there were two unsuccessful nests on a four-inch wide ledge on the South Pier Pavilion at Lowestoft, Suffolk—both unusual sites for this species. A pair of Fulmars (*Fulmarus glacialis*) bred in N. Devon for the first time. Several reports indicate that Stonechats (*Saxicola torquata*) had a good breeding-season and that there were more pairs than usual. A pair, for example, near Holt, Norfolk, represented the first breeding record in the north of that county for about 18 years. Again one is tempted to consider the possibility of a link with the movements of last February and March (*antea*, pp. 132 and 164). Finally, a Redwing (*Turdus musicus*) was seen in song in the Lake District on 28th June: no evidence of nesting was obtained.





## BIRDS OF THE BRITISH ISLES

David A. Bannerman and  
George E. Lodge

Vol. I	376 pages	
41 colour plates		63s.
Vol. II	310 pages	
41 colour plates		63s.
Vol. III	408 pages	
51 colour plates		63s.
Vol. IV	280 pages	
29 colour plates		63s.
Vol. V	368 pages	
34 colour plates		63s.
Vol. VI	326 pages	
26 colour plates		63s.
Vol. VII	256 pages	
27 colour plates		63s.

## BIRDS OF SCOTLAND

E. V. Baxter and L. J. Rintoul  
816 pages 2 colour plates  
2 vols. 24 half-tone plates  
63s. net.

## BIRDS OF IRELAND

P. G. Kennedy, R. F. Ruttledge  
and C. F. Scroope  
454 pages 11 half-tone plates  
42s. net.

## BIRDS OF LANCASHIRE

C. Oakes  
394 pages 31 half-tone plates  
21s. net.

## BIRDS AND MAMMALS OF SHETLAND

L. S. V. and U. M. Venables  
404 pages 8 half-tone plates  
30s. net.

## A BIRD WATCHER IN KENYA

Vernon D. van Someren  
270 pages 32 half-tone plates  
30s. net.

Send for Bird Book List to

**OLIVER & BOYD**

Tweeddale Court, Edinburgh, 1

## SMALL ADVERTISEMENTS

**MINSMERE BIRD RESERVE, SUFFOLK.** Full-time warden required. Candidates must be physically fit, aged between 21 and 45, with a sound knowledge of birds and the ability to guide and instruct visitors. They should also be capable of doing reserve maintenance work during the winter. Salary £400-£500 according to qualifications. For further details apply to R.S.P.B., 25 Eccleston Square, London, S.W.1.

9 x 40 Wrayvu Binocular £18/18/0, exchanges, repairs, lists. Bass & Bligh, 18, Market Arcade, Leeds 1.

**BINOCULARS AND TELESCOPES.** New and used. Descriptive lists and expert advice on request. Exchanges, overhauls. J. R. Hebditch, F.B.O.A., F.S.M.C., 44 Hallgate, Doncaster.

**BINOCULARS AND TELESCOPES,** new and reconditioned, at reasonable prices. Approval allowed, also part exchanges. Lists from Hatton Optical Co. Ltd., Lansdowne, Bournemouth, Hants. (Established 1930).

**BINOCULARS AND TELESCOPES,** repaired, cleaned and adjusted; send your instrument for estimate by return. Hatton Optical Co. Ltd., Lansdowne, Bournemouth, Hants.

FINEST VALUE YET

£10 19s. 6d.

### PRISMATIC BINOCULARS

30 mm. objectives, coated for extra light transmission under poor lighting conditions.

Magnification  $\times 8$ . Field of view 140 yards at 1000 yards. Centre wheel focussing. Weight 17 oz.

*Complete with lanyard and purse-type case with sling*

IDEAL FOR BIRD WATCHING  
AND ALL SPORTS

SENT ON 7 DAYS' APPROVAL

**M. W. DUNSCOMBE, Ltd.**

(Dept. PT),

5-7, St. Augustine's Parade,  
Bristol 1.

Phone 22155 (3 lines) Est. 1797

*Repairs and overhauls of  
Binoculars and Telescopes at  
reasonable prices.*

*Estimate if desired.*

★ ADMIRALTY RELEASE ★

# 7 x 50 CANADIAN NAVAL BINOCULARS

FIVE YEARS  
GUARANTEE

£60 VALUE FOR  
**£22**



An unparalleled opportunity to obtain a modern, high quality prismatic Binocular at a fraction of today's cost. Made in Canada to beautifully streamlined design of Bausch & Lomb. Individual eyepiece focussing. Tremendous penetrating power with unequalled brilliance and sharp, crisp images at all distances. As new condition, with superb case.

ALSO AVAILABLE IN USED BUT FULLY  
GUARANTEED CONDITION **£19-18-6**

**14 DAYS FREE TRIAL WITH MONEY BACK  
GUARANTEE**

# 6 x 30 CANADIAN NAVAL BINOCULARS

Also of Bausch & Lomb design, this eyepiece focussing Binocular is beautifully streamlined and a joy to handle. Terrific field of view is combined with unsurpassed definition, and depth of focus is unusually great. A magnificent general purpose glass that will give trouble-free pleasure for a lifetime. Would cost today approximately £30. Offered complete with fibre or web case.

**£10-15-0** LEATHER CASE  
£1 EXTRA

# CHARLES FRANK

**67-75 SALTMARKET, GLASGOW, C.I.**

Telephone : Bell 2106-7

Telegrams : Binocam Glasgow

*Optical Specialists for half a century*

# BRITISH BIRDS



NOVEMBER 1958

THREE SHILLINGS

# BRITISH BIRDS

AN ILLUSTRATED MONTHLY MAGAZINE

Edited by

E. M. NICHOLSON

W. B. ALEXANDER                      A. W. BOYD

I. J. FERGUSON-LEES

P. A. D. HOLLOM                      N. F. TICEHURST

*Editorial Address:* 30, St. Leonard's Avenue, Bedford.

*Photographic Editor:* G. K. YEATES

Annual Subscription £2 (including postage and despatch)  
payable to H. F. & G. Witherby Ltd., 5, Warwick Court, London, W.C.1

---

---

## CONTENTS OF VOLUME LI, NUMBER 11, NOVEMBER 1958

---

	PAGE
Editorial: The London Natural History Society's Centenary ... ..	409
Further notes on the Tufted Duck in St. James's Park, London. By E. H. Gillham ... ..	413
The behaviour of adult tits towards other birds and mammals near the nest. By Dr. Monica M. Betts ... ..	426
Reviews:—	
<i>A Study of Blackbirds.</i> By D. W. Snow ... ..	429
<i>Birds on the Spurn Peninsula, Part I.</i> By Ralph Chislett and G. H. Ainsworth ... ..	430
Filmstrips: <i>Summer Migrants</i> (from photographs by Eric Hosking), <i>British Woodland Birds</i> (from photographs by John Warham) and <i>The Sedge Warbler</i> (from photographs by Ernest Mytum, etc.). Explanatory booklets by Philip Brown ... ..	431
Recent reports and news. By Kenneth Williamson and I. J. Ferguson-Lees ... ..	432
"Recent reports and news" and the forthcoming "Bird Migration" bulletin. A joint statement by the Editors of <i>British Birds</i> and the President of the British Trust for Ornithology ... ..	446
Request for Information:—	
The winter status of the Eider and the Long-tailed Duck (J. H. Taverner) ... ..	447
Letters:—	
The distribution of the Frigate Petrel (Dr. David A. Bannerman; John Warham) ... ..	447
"The Birds of Suffolk" (Major William H. Payn) ... ..	448

---

Cover photograph by G. K. Yeates: Dotterel (*Charadrius morinellus*)

VOL. LI

No. II

NOVEMBER

1958



# BRITISH BIRDS

## EDITORIAL

### The London Natural History Society's Centenary

THE NETWORK of local reports and national enquiries is now taken very much for granted, and we tend to forget that these are a comparatively recent development which only grew out of the rise in the popularity of watching and studying birds that began as lately as the early 1930's. In this development local natural history societies and bird clubs have played a major part. The earliest naturalists were handicapped by their lack of numbers and the difficulties of communication, and it was not until the second quarter of the nineteenth century that the first notable magazines devoted to natural history were born. In 1829 *London's Magazine of Natural History* started a ten-year career, the *Annals of Natural History* was begun in 1841 and two years later came the *Zoologist*. The *Field* did not start until 1853.

This year the London Natural History Society is celebrating the centenary of the first of the local natural history organizations from which it traces its descent. The founder members of the Haggerstone Entomological Society were, as the name implies, all entomologists, and there is no evidence of any great interest in birds until 1892 when the then President was appointed Recorder for birds, giving a review of the list of London birds as his presidential address a year later. Up to the time of the First World War the society remained predominantly entomological in spite of a change of name to the City of London Entomological & Natural History Society.

In the meantime, however, another ancestor of the L.N.H.S., the Clapton Naturalist's Field Club, had been founded by four boys in 1886, becoming in 1892 the North London Natural History Society, with much wider interests than its rival. In 1897, Oliver G. Pike was lecturing on the nesting habits of birds, and in 1908 the first organised ornithological work began with the formation of a research committee. In 1910 can be traced the first association with this journal when the committee was already taking part in the Ringing Scheme.

In 1913 the two societies decided to merge as the London Natural History Society, adopting a circle of 20 miles' radius from St. Paul's Cathedral as the new area of operation. Until 1921 the society published *Annual Transactions* with details of all meetings, but in that year the form was changed and the annual publication became the *London Naturalist*. Early contributions on birds were practically confined to notes from Epping Forest, but in the 1920's there appeared some valuable individual work. There was a paper on "The birds of Walthamstow Reservoirs", and since 1922 the reservoirs at Staines, and to a lesser extent Littleton, had been watched assiduously by observers with a national reputation—W. E. Glegg, Dr. G. Carmichael Low and A. Holte Macpherson. The last of these had for a long time been producing annual reports on the birds of Inner London, which he continued for some fifty years. It would have been of enormous interest if the potentialities of the reservoirs and sewage-farms had been appreciated sooner and their early days as fully documented.

In the *London Naturalist* for 1928 there appeared a preliminary list of birds for the society's area, and it was followed in 1929 by the first contribution to bear some relation to the present idea of a county bird report. These were useful steps forward and they came just before a big increase in interest that was a remarkably exact reflection of the national trend. The number of contributors to the annual report rose from under 30 in 1930 to about 70 by 1933, and with the greater activity it was decided to select a few species for special study each year. Other signs of the approach of more organized effort were shown by co-operation with the organisers of the Great Crested Grebe (*Podiceps cristatus*) enquiry and the newly-formed British Trust for Ornithology.

Shortly afterwards the Council of the Society were persuaded that the growing interest justified a separate publication and R. C. Homes launched the first *London Bird Report* in 1936, the number of contributors reaching 100 two years later. In 1937 Homes organized the first attempt to estimate the total number of ducks, Great Crested Grebes and Coot (*Fulica atra*) frequenting the major waters in winter, a single census being made in December. In the following winter the census was repeated monthly from October to March, and thus the Society entered this branch of co-operative enquiry before the national wildfowl counts were born in 1948. Reviews of the status of selected species continued to appear, but efforts to make a study of the birds of suburban gardens and of agricultural land did not make much headway and were doomed by the war.

During the late 1920's and the 1930's there had been a succession of important papers coming from Holte Macpherson and Glegg, which were later to prove invaluable. They included reviews of the Thames as a migration route, papers on the birds of Middlesex and the Lea valley reservoirs, the influence of the reservoirs on London birds, and an important list of the birds of Inner London.

Meanwhile, other authors contributed notes on the Norwood district, Edmonton sewage-farm and the gulls of the area. The war years saw further preparation for the eventual local history with R. S. R. Fitter's review of Starling (*Sturnus vulgaris*) roosts, a checklist for the area by Fitter and E. R. Parrinder, and notes on Elmers End sewage-farm by G. E. Manser. Co-operation with the British Trust for Ornithology in the Rook (*Corvus frugilegus*) enquiry and immediate concentration on the spread of the Black Redstart (*Phoenicurus ochruros*) as a breeding species in London were other useful wartime activities.

After the war the number of contributors to the report was at once doubled, and the Society shared in the general wave of enthusiasm for watching birds. It was important to channel as much as possible of the enthusiasm into useful studies, and in addition to taking part in many B.T.O. enquiries the Society launched several lines of enquiry of its own. Work was begun on collecting information for a book on the birds of the area; the wildfowl census was resumed several months before the national scheme was announced; an enquiry was started into the birds of four selected gravel pits, while S. Cramp and W. G. Teagle pursued their own individual studies which yielded a succession of interesting papers on the density and distribution of birds in the central parks and on the reaches of the Thames in the heart of London. A new list of birds of Inner London by the same authors was another valuable preliminary to the book. The origin of the hordes of Starlings which roost on London trees and buildings had long been contentious and was now tackled with enormous enthusiasm by a team of workers who ringed several thousands of the birds in Trafalgar Square. The chief conclusions were embodied in the book, but it is one of the drawbacks to research by amateurs with limited time for ornithology that the final results often come, as in this case, so long after the event.

The gravel-pits enquiry was well supported and resulted in a paper by W. D. Melluish revealing clearly the great influence of these artificial lakes on bird distribution. The wildfowl census has shown how unreliable figures from single waters may be in comparison with the wider pattern of duck movements in a larger area, and has also proved that the total numbers have gone up steadily for several years. Similarly co-operation with the B.T.O. gull roosts enquiry provided for the first time an estimate of the numbers roosting on the London reservoirs, close on 100,000 in the winter concerned.

After the gravel-pit investigation a small group of members under B. S. Milne began a two-year survey of the birds of a sewage-farm, at Beddington, with special reference to the effects of farm management, and this was followed by a very successful start on co-operative ringing on the farm.

So far only the work of the ornithological section has been described, but the Society is equally interested in all the main

branches of natural history and is therefore free from the narrow outlook of some exclusively ornithological bodies. The work of the ecological section, especially, inevitably concerns and enlists the ornithologists, and, in both the long-term ecological surveys of Bookham Common and of the City bombed sites, results of much more than local importance have been achieved. Of the ornithological aspects of these surveys we must particularly mention the study by Dr. G. Beven of the bird population of a Bookham oakwood and P. W. E. Currie's series of notes on the adaptation of birds to the exceptional conditions created by the London blitz.

In 1957 much of the earlier effort culminated in the appearance of *The Birds of the London Area since 1900*, edited by a committee under R. C. Homes, lately President of the L.N.H.S. and now President of the B.T.O. This 305-page testimony to the industry and accumulated knowledge of the Society has already been reviewed in this journal (*antea*, vol. L, pp. 210-212). The product of the work of hundreds of members, it was essentially a co-operative undertaking and a reflection of the peculiar environmental conditions in one of the world's largest urban agglomerations. Watching birds in London parks, at reservoirs, gravel-pits, sewage-farms and rubbish-dumps is not aesthetically satisfying, but it provides great opportunities for studying their adaptation to a strange and changing environment. It is very unfortunate that this invaluable book is already out of print.

We are glad on this occasion to be able to pay tribute to a society which can trace its origins so far back and which has made such good use of the opportunities provided. The rôle of the local natural history societies and bird clubs in the modern world is an important one. More and more people are becoming divorced from close association with the land as it becomes increasingly difficult to get away from cities and suburbs, and it is the local organisation which is in the best position to foster an interest in things of the countryside. As demands on the use of land continue to grow, it is more and more important for the protection and study of birds that there should be a wider public interest in the country. The local society has to cater for all levels of interest, and the need to maintain and expand membership to meet the ever-increasing administrative costs has to be balanced against desires to urge members on to taking a more serious interest in what is, after all, their hobby. It is, therefore, all the more creditable that so much work of such high standard should have been undertaken by the L.N.H.S. and so many papers of scientific value produced. A rapidly increasing membership shows that this vigorous and ambitious policy attracts the support which it deserves, and it is encouraging that so many who have led and organized these recent efforts are still relatively young.

In offering the society our congratulations on its achievements and our good wishes on its Centenary, we look forward to its further progress with confidence.



# FURTHER NOTES ON THE TUFTED DUCK IN ST. JAMES'S PARK, LONDON

By E. H. GILLHAM

## INTRODUCTION

THIS PAPER on Tufted Duck (*Aythya fuligula*) in St. James's Park deals primarily with observations for 1956 and 1957. In addition, however, certain information gained during the previous three years, 1953-55, is summarized for the first time with the comparable details for 1956-57, and the general picture of events outlined in a previous paper (Gillham, 1957) is brought up to date.

As in previous years, observations were made between late April and early October as follows:—

On 90 days (twice in a day on 24) in the 140-day period 18th May-5th October 1956.

On 128 days (twice in a day on 39) in the 171-day period 23rd April-10th October 1957.

During both breeding-seasons visits were regular, averaging on 4 days out of 7 in 1956 and on 5 days out of 7 in 1957. Daily counts, and the close scrutiny of birds at the various feeding points, as outlined previously (Gillham, *op. cit.*), were continued throughout both years.

For almost the entire 1957 breeding-season, the construction of two widely-spaced parallel dams, with a drained pit between for bridge-building, divided the lake into two separate waters. This was of great assistance to counting and observation for, apart from the movement or attempted movement of several newly-hatched Tufted broods from one portion to the other, there was no other passage of families or of independent ducklings between the Horse Guards end and Palace end lakes.

### *Correction to a previous paper.*

Under *Desertion of young by the female* (*antea*, vol. L, p. 4), the nine broods in 1955 were hatched between 2nd July (not 29th July) and 12th August.

### *Number of pairs.*

The number of pairs present in the two most recent years was 14 in 1956 and 18 in 1957. Between 1954 and 1957, inclusive, the number of pairs attempting breeding each season ranged from 12 to 18.

### *Non-breeding birds.*

In 1956, unmated non-breeding birds present during the first half of the nesting-period totalled 6 or 7 adult males and 2 or 3 adult females, and in 1957, 6 to 9 males and up to 3 females. During 1954, another year of intensive watching, there was also a marked surplus over the breeding pairs, likewise mainly males.

## NESTING ; HATCHING AND FLEDGING OF YOUNG

*Span of the nesting period.*

The nesting period (Fig. 1) is based partly on calculations made on 50 broods and partly on field observations on the territorial behaviour of pairs. Observations on behaviour have indicated that the hatching-period should commence from the beginning of June, but these early nesting attempts have so far been unsuccessful. In any case, the number of broods which should have appeared in June is very small, since between the last few days of April and the third week of May territorial pairs were considerably fewer than those seen in the period 22nd May-13th June.

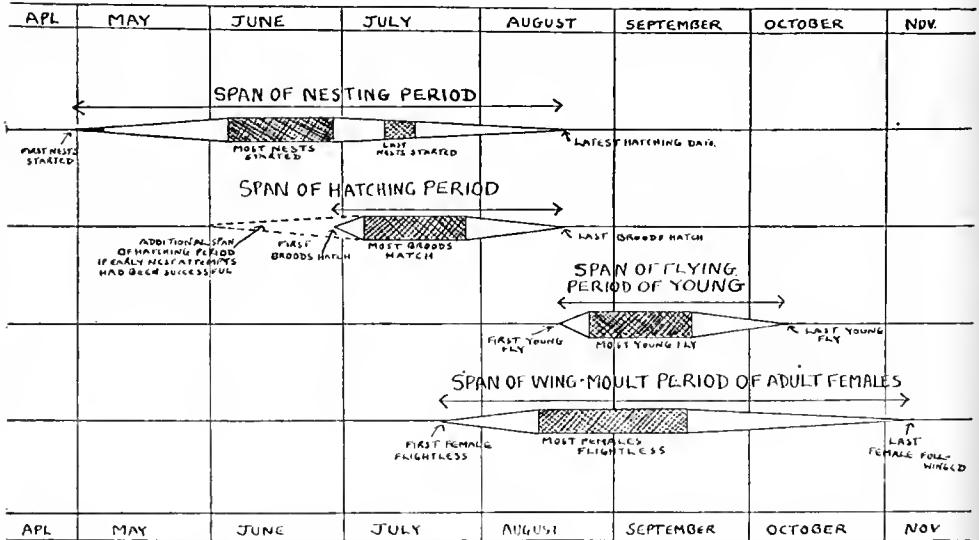

FIG. 1.—TO SHOW THE TOTAL SPANS OF THE PERIODS OF NESTING, HATCHING, FIRST FLIGHTS OF YOUNG, AND WING-MOULTS OF ADULT FEMALES, OF TUFTED DUCK (*Aythya fuligula*) IN ST. JAMES'S PARK, LONDON

The nesting season begins with a thin population of breeding pairs, then rises fairly sharply to a peak period during which most birds start nesting, after which there is a gradual decline until the last broods hatch. The flightless period of adult females begins with a small number of flightless birds, rises sharply to a peak period when most females are flightless, and similarly declines gradually.

*Span of the hatching period.*

The span of the hatching-period in relation to the spans of nesting and fledging of young is shown in Fig. 1. In some cases hatching dates had to be estimated because the exact age of ducklings was unknown, and it is convenient to group the hatching of broods in 8-day periods:—

27th June-4th July	2 broods hatched
5th July-12th July	10 broods hatched
13th July-20th July	12 broods hatched
21st July-28th July	15 broods hatched
29th July-5th August	5 broods hatched
6th August-13th August	4 broods hatched
14th August-21st August	2 broods hatched (this includes an estimated hatching date for a female incubating on 16th August 1954)

*Fledging period of individual ducklings.*

In *The Handbook* it is stated that young Tufted Ducks are able to fly at six weeks. Observations on certain broods in 1953 and 1955 indicated that a fledging period of six weeks could be regarded only as a minimum. In 1956 and 1957 closer observation on broods, especially on nine broods watched until deserted by their mothers at ages ranging from 39 to 43 days, showed that at 42 days old *none* was capable of flight. One bird was seen to fly a few yards just above the water at 44 days; from age calculations at least twelve birds could fly well between 7 and 8 weeks old.

## MIXED BROODS OF TUFTED DUCK AND MALLARD

In 1957, four newly-hatched Tufted ducklings formed part of a similarly aged brood of Mallard (*Anas platyrhynchos*) and received the same attention from the female as the downy Mallard. This mixed brood was almost certainly the result of a female Tufted's laying in a Mallard's nest, for it is very unusual for female Mallard to tolerate a close association of strange ducklings even of their own species (i.e., ducklings not hatched out in a Mallard's own nest), with their own broods. Both of the two surviving Tufted of this mixed brood eventually deserted their foster-mother when about two-and-a-half weeks old and reared themselves.

Laying in the nest of another species is probably by no means rare in the Park, for I have known two newly-hatched Mallard to be part of a newly-hatched Tufted brood and a Red-crested Pochard (*Netta rufina*) duckling amongst a fresh brood of Mallard. In all cases these ducklings were accepted by their foster-mothers.

(Since the completion of this paper there have been three further instances of *newly-hatched* Tufted ducklings with foster-mothers of another species:— (1) a female Pochard (*Aythya ferina*) with a brood of six, including three Tufted, on 30th June 1958; (2) a female Mallard with five, including two Tufted, on 8th July 1958; and (3) a female Mallard with four ducklings—all Tufted—on 14th July 1958. The last record, in particular, raises the question whether other species sometimes take over a Tufted Duck's nest in the laying period.)

## CLUTCH SIZES AND BROOD SIZES

Brood sizes are based solely on the number of young in the various broods of tiny ducklings when they were first seen on water. The following summary refers only to 1956 and 1957, the years for which figures are particularly accurate:—

## Number of young in broods

Brood sizes	1	2	3	4	5	6	7	8	9	10
Number of broods of the brood sizes detailed above	2	1	1	5	7	3	1	4	1	2 = 27 broods

The average brood size was between 5 and 6 young, whereas data relating to eighteen full clutches found in 1954 and 1955 (W. G. Teagle, *in litt.*) give an average clutch size of 9 eggs. There is a possibility that a proportion of eggs fail to hatch as has been reported for the Red-breasted Merganser (*Mergus serrator*): in a study of twenty-two clutches of this species on Schliemunde, Germany, Pflugbeil (Hamerstrom, 1957) found that of at least 262 eggs only 53% hatched, while the average number of unhatched eggs was 1 to 4 per nest. In St. James's Park there is positive evidence of a few eggs in nests after hatching, for in 1954 Mr. W. H. Punter (Teagle, *in litt.*) found that, out of two Tufted Ducks' nests holding 20 eggs, a fifth failed to hatch. Rather less conclusive are my own observations of two different females leaving their newly-hatched young on water and returning to, and sitting on, their nests. This apparently unusual behaviour may have been associated with unhatched eggs remaining in these nests though, regrettably, in neither case was it possible for me to confirm this by inspection.

Although in the five years personal opportunities for studying nests have been few, I know of single instances of (a) 2 dead young being found in one nest, (b) a broken egg in a nest, and (c) an egg lying just outside a nest. In addition, Mr. Teagle informed me that 4 of 12 eggs—the combined total laid in two nests—disappeared in the incubation period. These incidents point to a combination of factors being responsible for the low average brood size.

In considering the average brood size it is necessary to make some allowance for a percentage of broods resulting from second nest attempts. This should lower the average brood size, for it is highly probable that with Tufted and other species the clutch sizes of second attempts are generally smaller than those of first layings—as has been reported for some North American wild ducks (Farrington, 1947).

(The following evidence, obtained since the completion of this paper, suggests that a return to the nest by the female after most eggs have hatched is associated with unhatched eggs remaining. On 11th July 1958, I was informed by Mr. A. May that a female Tufted Duck, without any young, was seen at a nest containing one egg. I examined this nest the same evening and found, in addition to one cold egg, the usual chips of shells indicating hatching. Originally this clutch consisted of seven eggs—including one lying eighteen inches outside the nest—and on the morning of 11th July there was a fresh brood of five, with parent, on the lake.)

#### AMALGAMATION OF BROODS

Amalgamation of two or more broods of tiny young of the same species under one mother is well known with the Shelduck (*Tadorna tadorna*) and with many kinds of diving ducks. The

single instance of a large grouping of small Tufted in St. James's Park was in 1957 when the care of three newly-hatched broods (Nos. 16, 17 and 18 in Table II) devolved on one of the three females within about sixty hours of these broods' reaching the water (see Table II). In his study of the uniting of broods of the Red-breasted Merganser, Bergman (1956) found that, when two females with their broods happen to meet, the parents react more or less aggressively, the weaker mother often leaving its young for some minutes. If the aggressive or escape behaviour is strongly activated, this behaviour releases a marked increase in the uniting drive of the young which give their distress calls and huddle together. If the broods are of the same age and the uniting drive is strongly activated, they join each other, too, and swim away conducted by the stronger female. This appears to be a sound explanation for *some* amalgamations, though I would add to it that I consider that the weaker mothers may be those whose wing-moult is soon to begin. From Bergman's explanation, however, it is not to be implied that, say, the large broods of 30, 40 and 80 Shelduck of various sizes (*cf.* Gillham and Homes, 1950), or the group of 85 two-weeks-old White-winged Scoters (*Melanitta fusca deglandi*) and the broods of 20 or more Lesser Scaup (*Aythya affinis*) mentioned by Hochbaum (1944), result solely from "battles" between brood females when they meet. Hochbaum points out that the instinct to follow is strong amongst deserted flightless ducklings at Delta (Manitoba, Canada) and the same is particularly true of Shelduck on the North Kent foreshores.

Like Mallard, some Tufted mothers attack stray ducklings of their own species which try to join their broods, and this may in part explain why the uniting of Tufted broods has been infrequent. From close observation on the 1957 amalgamated brood, it was often noticed that the foster-mother attacked individuals of her large brood, which pointed to her recognizing that some of these ducklings were not of her original family. Amalgamation of a few ducklings with a brood of similar age probably occurs with fair regularity in Tufted Ducks, especially when the brood female's hostile behaviour to strange young with her family is beginning to wane.

Fluctuating daily brood totals in Tables I and II indicate that temporary reductions and temporary increases in the sizes of a family frequently occur.

#### UNATTACHED YOUNG

In 1955, 1956 and 1957 a few lost or deserted ducklings were present on the lake when only a day or two old. It was not uncommon for a female to lose one or two of her brood within a few days of getting them to water for the first time. Sometimes these lost ducklings rejoined the brood, but sometimes they remained alone and reared themselves. In cold and wet weather they died quickly, but if good weather predominated during their





first 14 days of life the survival rate was high. Even in spells of good weather some nights are extremely cold and one wonders how these tiny ducklings keep warm. In daytime, however, tiny independent ducklings have been seen to leave the water and, for a short while, nestle close to strange Tufted broods resting ashore, so there is no apparent reason why such behaviour should not occur at night, too.

#### NANNY FEMALES

“Nannies” are non-breeding or post-breeding unattached females (either full-winged or flightless) which assume the rôle of mother over small, temporary or permanently lost ducklings. Although most nannying has been observed only for parts of single days the behaviour calls for comment. During 1953, 1955 and 1956 observations were inconclusive, but at times counts indicated either that extra females with odd medium-sized downy young had suddenly appeared when a steady decline in the total of brood females was taking place (through desertions), or that even the most accurate counts of family parties were at fault.

In 1957, however, a closer watch was kept for this behaviour and the first conclusive evidence was obtained for Pochard. Throughout the breeding-season there was only one brood of this species on the Horse Guards Lake and at 07.40 hours on 1st July this family consisted of the female and two surviving young then aged seven days. At 12.00 hours on the same day this bird had only one young, while on a different part of this water another female Pochard was behaving *exactly* like a mother and attending the second downy duckling. The following day both ducklings were with their own mother in her usual corner of the lake.

By the end of the 1957 season several cases of nannying by Tufted females were also established. In one instance a full-winged female (known by a narrow strip of white at the base of her upper mandible throughout the nesting season to have been brood female No. 13 in Table II, who had lost her brood two weeks beforehand) was seen to mother the only lame duckling of the amalgamated brood (Nos. 16, 17 and 18) on both 23rd and 26th July. On the first date this female was seen to brood the lame youngster ashore and on the second occasion she drove off two male Mallard swimming close to the same duckling. Another female started to look after a three-weeks-old duckling just after shedding her flight feathers and continued to attend the same one for the next fourteen days.

In every case the nannies' behaviour was indistinguishable from that of a typical mother attending her own brood. Although these nanny females do not appear to have any particular biological significance it is useful to know that they occur, for their presence can distort the counts of family parties and perplex the person making the counts if he or she is unaware of their existence.

An incident not dissimilar to the cases of nannying already



mentioned is given by Hochbaum (*op. cit.*) who quotes an observation by Monro of a yearling (non-breeding) female Barrow's Goldeneye (*Bucephala islandica*) which attempted to usurp the brood of an older female.

#### DESERTION OF YOUNG BY THE FEMALE

##### *Pattern of desertions.*

The pattern of desertions was similar to that described for 1953 and 1955. In 1956 all females had abandoned their broods by 1st September, and in 1957 by 13th September: during these two years no mother stayed with her young later than the 43rd day after they had reached water.

##### *Desertion of young within a few days of their reaching water.*

It has been mentioned in an earlier paper (Gillham, *op. cit.*) that a brood was deserted when a few days old, and it will be seen later here that females may have to desert their young within a fortnight of hatching if they are to proceed to a moult area outside the Park. In 1955 and 1957 there were instances of 3 broods being deserted within four days of their reaching water (in one case on the very day they reached water). However, not all early desertions may be correlated with the approach of a brood female's wing-moult. Since two females have been seen to leave their newly-hatched young and return to sit on their nests shortly after taking their ducklings to water for the first time, some early desertions may result through an urge to return to the nest (? associated with unhatched eggs remaining there) overcoming the urge to attend the brood. In the first of these two occurrences the female (No. 7 in Table I) did not lose her brood, although only one of the six ducklings managed to get back to the nest. In the second instance, however, the female (No. 13 in Table II) returned quickly to her brood after sitting on the nest, but an hour or so later the same four young were roaming the lake alone, which suggests the possibility that the female lost them through a further visit to the nest. This brood probably died the same night as they were not seen again. Their mother, whose distinctive recognition mark has already been described, was still present two weeks later at which time she had not begun her wing-moult.

If a nest is in such a position that it is impossible for the young to get back to it, and, more particularly, if a brood female does not call the young to follow when this urge to return to the nest dominates her, it is not difficult to visualize how losses of very small young can occur. It may not be without significance that the nest-sites to which these females returned, after taking their young to the water, were the only ones to be kept under close observation for a long period.

#### MORTALITY OF YOUNG

The average mortality in the 1956 and 1957 fledging-periods

was found to be 50% of all ducklings which reached water. It is believed that an average of 70% of all casualties in these two years were ducklings aged between one and seven days.

The heavy mortality in 1957 (and in 1954 as well) was almost entirely due to this period of maximum vulnerability coinciding with cold and wet weather. Ducklings of up to about ten days of age feed largely on insects and matter taken from the surface, and in cold wet weather there is an obvious shortage of the former. An absence of vital food coupled with bad weather in this critical period of their lives must be an important factor affecting survival. In 1957, the first six broods (see Table II) hatched in the cold and wet spell between 8th and 18th July; all died within a week of reaching water. These 29 ducklings represented *ca.* 53% of the total casualties for the season.

Total mortality of young which reached water

Year	Number to reach water	Number to reach flying stage	Percentage of young to die in fledging period
1956	45	25	44.4%
1957	107	52	51.4%

Mortality of young within 7 days of reaching water

Year	Number to die in fledging period	Number to die in their first 7 days	Percentage of total casualties which died in their first 7 days
1956	20	<i>ca.</i> 9	<i>ca.</i> 45%
1957	55	<i>ca.</i> 44	<i>ca.</i> 80%

ADULT FEMALES IN WING-MOULT

*Number of adult females completing their wing-moult on the lake.*

In 1956, 11 adult females (out of a maximum population of 17) moulted their flight feathers on the lake; and in 1957, 12 (out of 21). Thus, in the two years, 60% of all adult females, mainly breeding birds, stayed to complete their wing-moult, most of them departing soon after regaining their powers of flight. Compared with the period 1953-55, more adult females completed their flightless period on the lake.

*Span of the wing-moult period.*

Between 1953 and 1957, inclusive, a total of 37 adult females (roughly 45% of all females present in the five nesting-seasons) completed their wing-moult on the lake, most of them being seen in this condition, initially, just after shedding their flight feathers. In view of the intensive observation during the moult period it is unlikely that more than an odd flightless bird was missed. The

data on these 37 birds form the basis of the span of the wing-moult period shown in Fig. 1. It is possible that one or two of these females came to the lake to moult from a breeding area outside the Park.

*Duration of wing-moult in individual birds.*

From close observation on four birds the duration of the flightless period was between  $2\frac{1}{2}$  and 4 weeks, which agrees with the period given by Hochbaum for some of the Delta diving ducks.

*Flightless brood females continuing to attend their young.*

During his studies at Delta, in Manitoba, Canada, Hochbaum found no evidence of female diving ducks moulting their flight-feathers while mothering their broods. In a previous paper (Gillham, *op. cit.*), however, I gave two instances of such an overlap between part of a mother's wing-moult period and her brood-rearing duties, to which may now be added a further 3 occurrences in 1956 and 8 more in 1957. Although these 13 mothers ultimately deserted their broods before the young could fly, they tended their ducklings throughout part (and in one case all) of their own flightless period. Taking only the 11 females in 1956 and 1957 (see Tables I and II), for which the data are most accurate, the duration of the overlap varied up to 22 days, the average attendance on young being for 14 days following the beginning of a brood female's wing-moult. The ages of the eleven broods at the time when their mothers shed their flight-feathers were 14, 15, 18, 20, 21, 21, 22, 28, 28, 34 and 38 days respectively.

These figures give an idea of the differing ages of broods when their mothers *actually became flightless* and cause interesting speculation as to what *would have been* the ages of these eleven broods at the time of desertion had they been left on dates before their mothers became flightless. Does a mother who deserts her brood before her wing-moult leave the young a few days or a week or two before her flight-feathers are ready to drop out? Those female Tufted which leave the lake for a moult area outside the Park probably need to desert their young at least a week before their wing-moult begins if they are to undertake a long flight. Taking as an example from these eleven broods the ducklings which were 14 days old when their mother became flightless, it can be realized how downy young may be deserted at the age of only a few days through their mother's departure to moult elsewhere.

MOVEMENTS OF BREEDING FEMALES

In 1956, between 1st and 10th September, the number of adult females was 4 or 5 (under one-third of the breeding season population of adult females), though numbers rose later through the incidence of passage birds. The following year adult females

totalled 8 from 19th September and 4 or 5 (approximately one-fifth of the breeding season population) from 4th October. In both years the departure pattern—before or after the wing-moult—was similar to previous years except that more females delayed leaving until after their flightless period. The span of the departure period is given in Fig. 2.

MIN DEPARTURE PERIODS	MAY	JUNE	JULY	AUGUST	SEPTEMBER	OCT.
ADULT MALES (TO A MOULT AREA OUTSIDE THE PARK)			-----	-----		
ADULT FEMALES (BEFORE & AFTER WING-MOULT)				-----	-----	
YOUNG (AFTER FLEDGING)					-----	-----

FIG. 2.—TO SHOW THE APPROXIMATE SPANS OF THE DEPARTURE PERIODS OF THE BULK OF THE BREEDING ADULT TUFTED DUCK (*Aythya fuligula*) AND THEIR YOUNG FROM ST. JAMES'S PARK, LONDON

#### ADULT DRAKES

The movement of adult drakes in 1956 and 1957 was similar to that in the two previous years. In 1956 most males had departed by 22nd July and on the 31st only two remained, both subsequently completing their flightless period on the lake. The following year most had gone by 27th July, but the 6 or 7 remaining throughout August had increased to 8-10 during 7th-16th September, after which numbers fell to 2 or 3 from 19th September. In this latter year 5 adult drakes certainly shed their flight-feathers on the lake and a sixth probably did so. The total number of males completing their wing-moult on the lake was *ca.* 10 during the five years 1953-57. The earliest that any of these ten drakes first became flightless was the middle of July and the latest time for a bird to regain its powers of flight was about the middle of September. The span of the departure period of the males which proceed to a moult area outside the Park is shown in Fig. 2.

#### DEPARTURE OF YOUNG

The departure of fully-winged juveniles of the year was similar to that recorded for 1953 and 1955. Counts of the number of juveniles on the lake were as follows:—

##### 1956

31st August, 25 (total to reach flying stage); 6th September, 19; 7th September, 30 (a marked influx of passage birds); 11th September, 10; 17th September, 17; 5th October, 12.

##### 1957

13th September, 52 (total to reach flying stage); 25th September, 40; 8th October, 25; 10th October, 14.

From these counts it will be seen that in 1956 a minimum of 50% of the original surviving young left the lake between 1st September and 5th October; and in 1957 just over 70% departed between 14th September and 10th October. To summarize the

movements of young for the four years 1953 and 1955-1957 inclusive, it can be said that an average of at least 57% of the surviving juveniles departed within four months of hatching and that most of the remainder left at some time between the middle of October and the following spring.

#### NOTES ON FOOD

On 3rd July 1957, a female was watched for about thirty minutes removing a broken egg from her nest. Three times she was seen to enter the water and eat pieces of shell, and she finally swallowed whole the two-thirds-grown embryo.

On 19th August 1957, two four-weeks-old ducklings were seen eating the leaves of a white poplar (*Populus alba*), which they plucked from overhanging branches touching the water.

On 28th and 30th August 1957, a total of three five- or six-weeks-old ducklings were seen eating off dead fish some 6-8 inches long. The fish were almost certainly Roach (*Rutilus rutilus*) or Rudd (*Scardinius erythrophthalmus*), many of which were noted dead or dying on the lake during this month.

#### ACKNOWLEDGEMENTS

I am indebted to W. H. Punter and W. G. Teagle, late of the Ministry of Works, and to A. May, the present Bird Keeper, for supplying me with information concerning nests and clutch sizes.

#### SUMMARY

1. The breeding and post-breeding populations of Tufted Duck in St. James's Park, London, were studied between late April and early October in the years 1953-1957 inclusive.

2. The females deserted their broods in the fledging-period, sometimes when the young were a few days old.

3. The adult males departed for the moulting grounds mainly in July.

4. Surplus non-breeding birds, mainly males, totalled between one-fifth and one-quarter of the whole adult population in most nesting-seasons.

5. Slightly under one-half of the adult females stayed to complete their wing-moult, some mothers becoming flightless while still attending their young. The span of the flightless period and its duration in individual adult females are given.

6. The order of departure of the population was the males first, then the females, and finally the young of the year.

7. Non-breeding or post-breeding adult females sometimes acted the rôle of mother to lost or deserted ducklings for very short periods; such birds are termed "nannies".

8. The average yearly mortality of ducklings was about 50% of all those known to have reached water and over half the total casualties were ducklings of up to 7 days of age. Heavy mortality occurred when cold and wet weather coincided with the first week of the duckling's lives.

9. Ducklings, deserted or lost when a few days old, reared themselves if good weather prevailed during the first few weeks of their lives.
10. The average size of 27 broods on reaching water in 1956 and 1957 was 5 or 6 young and probable reasons for the small size of family parties are discussed.
11. Occurrences of mixed broods of ducklings involving different species are given.
12. Notes are given on the spans of nesting and of the hatching and fledging of the young; and on the duration of fledging in individual ducklings.
13. Notes are given on food.

## REFERENCES

- BERGMAN, G. (1956): "On the uniting of broods of *Mergus serrator* and *Mergus merganser*" (English summary of paper in Swedish). *Fauna och Flora*, 1956 (3): 109.
- GILLHAM, E. H. (1957): "Notes on Tufted Duck in St. James's Park, London". *Brit. Birds*, L: 2-10.
- and HOMES, R. C. (1950): *The Birds of The North Kent Marshes*. London.
- HAMERSTROM, FRANCES (1957): Review of Pflugbeil (1956). *Bird Banding*, xxviii: 102.
- HOCHBAUM, H. ALBERT (1944): *The Canvasback on a Prairie Marsh*. Washington.
- KIP FARRINGTON, S. (1947): *The Ducks Came Back*. London.
- PFLUGBEIL, A. (1956): "Brüten des Mittelsägers auf Schleimünde 1955". *Die Vogelwelt*, 77: 44-47.

## THE BEHAVIOUR OF ADULT TITS TOWARDS OTHER BIRDS AND MAMMALS NEAR THE NEST

By MONICA M. BETTS

(*Edward Grey Institute, Oxford*)

THE FOLLOWING OBSERVATIONS were made during an intensive study of the food and feeding behaviour of tits (*Parus* spp.) at nests in boxes erected in the pine woods of Thetford Chase, East Anglia (Betts, 1956; Gibb and Betts, in progress), together with some notes made in 1951 at a nest of Great Tits (*P. major*) in oak woods of the Dean Forest, Gloucestershire (Betts, 1955a and b). Observations were made from hides attached to the nest-boxes as described in earlier papers.

### BEHAVIOUR TOWARDS OTHER BIRDS

In general, adult tits with nestlings paid little attention to other small Passerines in the vicinity of the nest. At late nests, fledged juvenile tits would frequently approach the box, presumably attracted by the calls of the nestlings, and at times would even peer through the entrance hole, but these juveniles were usually ignored by the adult owners of the nest. At one nest of Coal Tits

(*P. ater*) in early June 1955, a Wren (*Troglodytes troglodytes*) brought food to the young tits, which were almost ready to leave the nest. The Wren fed the young at the entrance and did not enter the box, and on two occasions its visits coincided with the exit of one of the parent tits from the box. In each case the adult Coal Tit took part of the food from the Wren, fed it to its young and departed, leaving the Wren to offer the remaining food to the young Coal Tits. (For other records of fostering by Wrens see Armstrong, 1955.)

The flight of a Sparrowhawk (*Accipiter nisus*) near the nest always interrupted the feeding visits of the parent tits, adult Coal and Great Tits giving a high-pitched "tsee" alarm note and the young becoming silent instantly. Occasionally the flight of a Woodpigeon (*Columba palumbus*) would produce a similar reaction. Feeding visits were also interrupted by the presence of Jays (*Garrulus glandarius*) or a Tawny Owl (*Strix aluco*) near the nest, but in these cases the adult Great Tits and Blue Tits (*P. caeruleus*) uttered "chiehiehi" scolding notes, while the Coal Tits used a series of "tsüi-ee" calls, the young of each species reacting to the parents' calls by becoming silent. Interruption in the feeding of nestlings by adult Robins (*Erithacus rubecula*) when Jays were near the nest has been recorded by Laek and Silva (1949).

An interesting display was observed in 1951 at a nest in a glass-backed box attached to a hide in the Dean Forest, when an adult Great Spotted Woodpecker (*Dendrocopos major*) attacked a brood of young Great Tits. At 07.23 hours G.M.T. on 8th June the female Great Tit brought food to the young and while she was at the nest, the woodpecker flew to the box entrance and peered through the hole, whereupon the female tit crouched over the nest, spreading her tail and holding her wings slightly drooped and spread, she waved her head from side to side, with beak held open and pointing upwards. Throughout the display the female remained quite silent, but the male Great Tit, which was near the box, uttered "chiehiechi" scolding notes interspersed by "twink" calls, while hopping about in near-by branches (its actual movements could not be seen as the woodpecker completely blocked the entrance hole). After a few ineffectual attempts to pull out the nest the woodpecker flew to the roof of the box, but the female tit continued her display although the intruder was no longer visible, ceasing only when the latter flew to an adjoining tree. The female tit then fled from the box and joined her mate in scolding, but by 07.27 hours both she and the male Great Tit returned to normal feeding visits.

Later, on the same day at 10.53 hours, the Great Spotted Woodpecker again attacked the nest while the female tit was inside the box. This time it succeeded in reaching the edge of the nest and began pulling out the nest material, dragging the occupants towards the hole with each pull. The female Great Tit, holding food in its beak, crouched down into the bottom of the nest, giving

no display until, to avoid possible loss of the brood, I left the hide and disturbed the woodpecker. The female tit remained crouching on the nest for 8 minutes and left when the male approached with food. Later I made the entrance hole slightly smaller and no further trouble from woodpeckers occurred.

#### BEHAVIOUR TOWARDS MAMMALS

In 1953, at one Great Tit's nest in Thetford Chase, a Red Squirrel (*Sciurus vulgaris*) descended to the base of the tree to which the nest-box was attached. The male Great Tit displayed vigorously at the squirrel, hissing and flicking its wings, or uttering high-pitched "twink" alarm notes and flying at it with wings held stiffly outstretched, but the female ignored both its mate's and the squirrel's activities and continued to visit the nest normally. The male Great Tit continued its display throughout the four minutes that the squirrel remained in the vicinity of the nest. The behaviour of the female Great Tit in this situation seemed remarkable, but Hinde (1952), experimenting with the mobbing reaction of Great Tits towards a stuffed and mounted Sparrowhawk, noted that in the breeding season the display of the female tit was less vigorous than that of the male. Pettingill (1937), however, described how a Red Squirrel in the vicinity of a nest of Acadian Chickadees (*P. hudsonicus*) was mobbed by both the adult birds. Hinde (*loc. cit.*) found little response by tits to Grey Squirrels (*S. carolinensis*) near the nest, but one display similar to that of the male Great Tit, described above, was observed in January, when a male Great Tit displayed at a Grey Squirrel which had entered a drey.

The presence of Man near the nest elicited scolding notes from all species of tits, the calls being similar to those used when Jays or owls were near, and resulting in the young ceasing to call.

#### ACKNOWLEDGEMENTS

Dr. David Lack, who directed the entire research project into the relationship between birds and their insect prey, kindly read and criticised this manuscript. Dr. J. A. Gibb and Mr. D. B. Summers shared in the hide observations at nests in Thetford Chase, while the Forestry Commission gave permission for the work to be carried out in the two State Forests. The work in the Dean Forest was financed by the Agricultural Research Council and in Thetford Chase by the Nature Conservancy.

#### SUMMARY

The behaviour of adult tits at the nest in the presence of small Passerines, Sparrowhawks, Jays, owls, Great Spotted Woodpeckers, squirrels and Man is described. Incidents recorded included the feeding of adult and young Coal Tits by a Wren and an attack by a Great Spotted Woodpecker on a brood of Great Tits.

#### REFERENCES

- ARMSTRONG, E. A. (1955): *The Wren*. London.  
BETTS, M. M. (1955a): "The behaviour of a pair of Great Tits at the nest". *Brit. Birds*, xlviii: 77-82.



- \_\_\_\_\_ (1955b): "The food of titmice in oak woodland". *J. Anim. Ecol.*, 24: 282-323.
- \_\_\_\_\_ (1956): "Further experiments with an artificial nestling gape". *Brit. Birds*, xlix: 213-215.
- HINDE, R. A. (1952): "The behaviour of the Great Tit (*Parus major*) and some other related species". *Behaviour*, Supp. II. Leiden.
- LACK, D., and SILVA, E. T. (1949): "The weight of nestling Robins". *Ibis*, 91: 64-78.
- PETTINGILL, E. R. (1937): "Grand Manan's Acadian Chickadees". *Bird Lore*, xxxix: 277-282.

## REVIEWS

A STUDY OF BLACKBIRDS. By D. W. SNOW. (*Allen and Unwin*, London, 1958). 192 pages; 23 drawings by Robert Gillmor. 21s.

THIS BOOK, by a former member of the staff of the Edward Grey Institute, gives us an admirable first-hand account of four years' observations on the Blackbird population of the Oxford Botanic Gardens. It is based on field observations of colour-ringed individuals, and, while the emphasis is on those aspects of population ecology on which the E.G.I. has concentrated in the last ten years, it contains a wealth of material on many parts of the species' life history and behaviour.

After two chapters on moult and plumages, and on food, the annual cycle is followed through the next nine chapters. Then we get a discussion on the timing of the breeding-season, on clutch-size, on breeding-success, on the Botanic Gardens population and some other populations, and a final chapter on "Blackbirds elsewhere".

It has not been Dr. Snow's intention to write a monograph, and he frankly says: "I have deliberately concentrated on aspects of the blackbird's life that have interested me". This accounts for some gaps which some readers might have liked to see filled; little is said, for instance, about migration, about social roosting, about the curious musical qualities of the summer song.

As a factual account, the book is extremely valuable. A very great amount of information is packed in it. Discussions are brief, to the point, and cautious; occasional critical remarks are straightforward and unbiased.

Here are some more samples of the kind of material the book contains. There are interesting facts about the phenomenon of feathers intermediate between the juvenile and adult plumage, which grow at a stage when the sex hormone level is not yet optimal.—Young Blackbirds try out a huge variety of objects and obviously learn what is palatable and what is not; as a result Blackbirds sometimes hit upon odd kinds of food, such as tadpoles, slow-worms, and fish; they can also hawk insects on the wing.—The alarm "see" shows all the characteristics of the obviously adaptive alarm calls of other songbirds which, as Marler

has shown, make them difficult for predators the size of a hawk to locate.—The vicissitudes of many individual young birds are followed, and some case histories are given.—The demographic evidence shows that a habitat like the Botanic Gardens produces considerably more birds than the territorial intolerance of those already established will allow to settle, and this causes a rhythmic overflow.

The text, while very readable, is a little dry. Scientific responsibility and modesty seem to have restrained the author from any speculation in print. Sticking out one's neck while others look on admittedly carries a risk, but it may occasionally give the onlookers a lead, and I am sure some readers, keen to learn how to continue, might have welcomed at least some hints about the way some unsolved problems could be attacked. I also think it is a pity that the reader is nowhere encouraged to share the delight I am sure the author must have felt in his birds; the book reveals to us Dr. Snow the competent scientist rather than David Snow the fellow naturalist. Apart from these minor and no doubt personal criticisms I have nothing but admiration for this book.

The illustrations by Robert Gillmor are excellent, and the book is attractively produced.

N. TINBERGEN

BIRDS ON THE SPURN PENINSULA, Part I. By RALPH CHISLETT and G. H. AINSWORTH. (*A. Brown & Sons, Hull & London, 1958*). 99 pages. 10s. 6d.

FOR SOME TIME many people have felt that a great deal of work was being done and a great deal of information being accumulated at bird observatories, but that there was a danger that all this work and information would be wasted for want of people prepared to analyse and draw conclusions from it. This attempt by the Chairman and Hon. Secretary to summarize ten years' observations (1946-1956) at Spurn Bird Observatory in Yorkshire is therefore greatly to be welcomed.

The present volume, which is Part I of the complete work, consists of a well-drawn map showing the location of the chief features of ornithological interest on the peninsula; a general introduction describing its ecology and history and something of the day-to-day work at the observatory; brief "gleanings from the logs" of each year; a summary of the status of Spurn's birds; a chapter on "winds and movements"; summaries of the recoveries of ringed birds; a section on the rarities "Turdidae to Prunella" (as in the Wetmore order); and "potted yearly histories" of the same range of species. Further "potted histories" of other species, including later records, are promised for Part II.

These chapters are of rather uneven interest to the general student of migration. The "gleanings from the logs", for example, are of largely local interest and this method of treatment

leads to a good deal of repetition, the items of ornithological importance appearing again in the "potted histories". The chapter on "winds and movements", one of the most important aspects of migration study, is disappointing. Although it contains much that is interesting, such as a description of the puzzling *southward* movements of diurnal migrants in spring that are also to be seen at Gibraltar Point in Lincolnshire at that time of year, the authors, while apparently accepting the theory of drift migration, seem to interpret it on the basis of purely local weather conditions. In discussing the great invasion of Turdidae on 6th November 1954, for instance, they state that strong north-easterly winds at Spurn indicate an origin of the movement from the north-east. Study of the relevant weather-map of Western Europe, however, shows plainly that the movement must have originated off the Dutch/North German coast, far to the south of an occluded front to the north of which the winds experienced at Spurn were blowing. Only in a fairly late stage of their flight did the birds come under the influence of the north-easterly airstream. The tracks of drifting birds are far more complex than can be guessed at from purely local wind-directions.

The most valuable part of the book is contained in the summaries of the occurrences of individual species and the yearly "potted histories" showing (separately) in tabular form the early records, late records and peak passage periods for each species in each of the years that the book covers. In a cautious final paragraph the authors say: "Much more evidence will need to be marshalled before 'conclusions' can be discussed". Nevertheless it is from such raw material as is summarized here that ultimately the bold (perhaps the rash) must "draw conclusions" and these summaries and those promised in Part II are therefore to be welcomed wholeheartedly.

R.K.C.

Filmstrips, with explanatory booklets by PHILIP BROWN: No. CX6203—SUMMER MIGRANTS (from colour photographs by ERIC HOSKING, 27s. 6d.); No. 5191—BRITISH WOODLAND BIRDS (from monochrome photographs by JOHN WARHAM, 15s.); No. 4861—THE SEDGE WARBLER (from monochrome photographs by ERNEST MYTUM, etc., 15s.). Published by *Educational Productions Ltd.*, London, 1957 and 1958.

THESE THREE FILMSTRIPS are produced in collaboration with the Royal Society for the Protection of Birds, whose Secretary has written the booklet which accompanies each. In "Summer Migrants" thirty-two species are illustrated in colour from beautiful photographs by Eric Hosking: most of these birds, including ten warblers, are portrayed at the nest, but a note of variety is introduced by pictures as widely differing as a Swallow in flight and a large flock of Dunlin resting on the tide-line. Though of the same length (32 frames), "British Woodland Birds"

shows sixteen species only, but the fact that some species have two or more frames enables particular features, such as nest-sites or young, to be illustrated: this filmstrip is in black-and-white, from photographs by John Warham, and here again the excellence of the originals is enhanced by good reproduction. The breeding-cycle of the Sedge Warbler, from nest-building to fledging, forms the subject of the third strip: the black-and-white photographs are by Ernst Mytum and several of the thirty-one frames are taken up by diagrams which are used to illustrate aspects of pairing and territory. In this third filmstrip a minor criticism of otherwise sound reproduction is that in several frames there is an excess of background, which tends to dwarf the birds.

The publishers state that the filmstrips are prepared for biology and nature study classes in Junior, Secondary Modern and Grammar Schools. That they will succeed admirably in this purpose is due in large measure to the accurate and comprehensive notes which Philip Brown has written in the booklets, though "The Sedge-Warbler" is more likely to be assimilated in the senior grades only. Yet it must not be thought that they are of use only in schools: speakers to local natural history societies, youth clubs and the like should take note of the possibilities provided by these and similar filmstrips produced by Educational Productions. G.R.S.

## RECENT REPORTS AND NEWS

By KENNETH WILLIAMSON and I. J. FERGUSON-LEES

**The items here are largely unchecked reports, and must not be regarded as authenticated records. They are selected, on the present writers' judgment alone, from sources generally found to be reliable. Observers' names are usually omitted for reasons of space and in case a report is subsequently rejected, and none of the items will be mentioned in our annual Index. Readers are asked to submit anything of interest as quickly as possible.**

We have already briefly mentioned (*antea*, pp. 361, 405) the spectacular drift-migration of early September. It is said that history never repeats itself, but there were many features of this movement which called to mind the equally memorable drift of early September two years ago. As might be expected, much the same species were concerned in both cases—Willow Warblers (*Phylloscopus trochilus*), Pied and Spotted Flycatchers (*Muscicapa hypoleuca* and *striata*), Whinchats (*Saxicola rubetra*), Redstarts (*Phoenicurus phoenicurus*), Garden Warblers (*Sylvia borin*) and Tree Pipits (*Anthus trivialis*)—but a cursory examination of the records for the two years shows some tantalizing differences. Although Wheatears (*Oenanthe oenanthe*) took part in 1958, those trapped at the east coast observatories suggest that the influx was largely of Northern ("schigleri") birds, whereas small-winged Continental Wheatears were concerned in 1956. Moreover, Red-

starts do not appear to have been nearly so abundant in the very north of Scotland as on the former occasion, though this was again a dominant species along the east coast from Aberdeen to Kent. And whereas the 1956 movement was largely confined to the North Sea counties, the recent one was much more widespread, its effects being felt as far west as the Irish Sea. A comparison of the species composition at various points, and of the meteorological background against which these invasions were set, will make a fascinating study, and the large number of reports received from all over the country provides excellent raw material for this task. We are grateful to those who have sent in reports, and hope that more may yet come to hand. Meanwhile, the only possible way to handle the situation within the limits set by the scope of these articles is to concentrate on giving a digest of the more uncommon birds and "rarities". Even this sets a problem, as so many interesting species were involved.

This summary is thus mainly confined to September.

#### RED-BREASTED FLYCATCHERS

One of the most striking differences from the September drift of 1956 was the large number of Red-breasted Flycatchers (*Muscicapa parva*), some two dozen individuals of this east European species being recorded during the month. The first appeared at Monks' House Bird Observatory (Northumberland) with a big "rush" of Pied Flycatchers and Whinchats which began at 11.00 hours on the 1st. At Fair Isle (Shetland) there was one from the 2nd to the 4th; and on the 3rd a bird of this species and a Barred Warbler (*Sylvia nisoria*) were removed together from a catching-box at Spurn Bird Observatory (E. Yorkshire). Two more Red-breasted Flycatchers were caught at Monks' House on the 3rd and 4th, and Fair Isle trapped 2 of 5 birds noted there on the 5th.

Another and more widespread influx took place in mid-month, with one on the 9th and 2 on the 17th at Fair Isle, and a second trapped at Spurn on the 13th, when 2 were seen not far distant at Flamborough, the observers suffering the mortification of losing one from a mist-net when it was almost in their grasp. One of these birds, incidentally, seemed to have set up territory and would not tolerate the other near it, often driving it out of the copse and chasing the odd Pied Flycatchers that appeared. Birds were trapped at the Isle of May (Firth of Forth) on the 11th and at Portland (Dorset) on the 12th, and one was seen at Ivybridge (S. Devon) on the former day. A Red-breasted Flycatcher which reached St. Agnes (Scilly Isles) on the 16th was trapped next day, whilst the first of 2 to be caught at Great Saltee arrived on the 17th, the other sharing the garden with 2 Spotted Flycatchers from the 18th to the 23rd. Finally, another appeared at the Isle of May on the 26th.

Experience at Fair Isle over the past ten years has shown that the Red-breasted Flycatchers are normally late September arrivals,

usually in company with the Yellow-browed Warblers (*Phylloscopus inornatus*); but this year their appearance, in unprecedented strength, was a good fortnight in advance of the expected time, and no reports of the Yellow-browed Warbler in September have reached us.

#### OTHER EASTERN PASSERINES

First among other eastern "rarities" may be mentioned a Greenish Warbler (*Phylloscopus trochiloides*) trapped at Gibraltar Point Bird Observatory (Lincolnshire) on the 3rd: the range of this bird is extending westwards in Scandinavia and this makes the thirteenth occurrence in Britain since 1945. A Richard's Pipit (*Anthus novaeseelandiae*) at Lundy on the 17th-18th is the second record for that island and there were three Red-throated Pipits (*Anthus cervinus*) at Great Saltee (off Co. Wexford)—on the 1st, 6th and 7th September. And it is curious that one of the only two Scarlet Grosbeaks (*Carpodacus erythrinus*) reported in September was as far west as Great Saltee; here one was trapped on 31st August and was noted again on 1st and 4th September. Fair Isle, normally a regular haunt of this bird in autumn, supplied the only other September record, of a single bird on the 15th.

Four Rose-coloured Starlings (*Sturnus roseus*) were reported, adult birds being seen among Starlings (*S. vulgaris*) at Watnall (Nottinghamshire) on the 1st and on the isle of Fetlar (Shetland) on the 7th-8th, with 2 juveniles visiting Fair Isle on the 12th.

Fair Isle was also richly endowed with rare buntings during September, pride of place going to a 1st-winter Yellow-breasted (*Emberiza aureola*)—a very scarce bird in Europe, even in the north-east—caught in a mist-net on the 9th and seen again next day. Young examples of both Rustic (*E. rustica*) and Little (*E. pusilla*) Buntings were trapped there on the 23rd, the former remaining till the 27th. Earlier, on the 13th, a Little Bunting had been identified at Shellness, Isle of Sheppey (Kent), and a Rustic Bunting which first appeared at Blakeney Point (Norfolk) on the 10th was taken in a mist-net on the 12th, and another Rustic was identified in the area of Doncaster (Yorkshire) on the 14th. An unconfirmed report of the latter species came from North Gare, Teesmouth (Co. Durham), on the 7th.

The Black-headed Bunting (*E. melanocephala*) is a species of south-east European origin and the male on St. Agnes in the Scillies already mentioned (*antea*, p. 363) may well have been a wild bird: first seen on 31st August, it stayed until 4th September. A male Red-headed Bunting (*E. bruniceps*), on the other hand, which was identified on 14th September among a flock of Yellow-hammers (*E. citrinella*) at Walton-on-the-Naze (Essex), is perhaps as likely to have escaped from captivity since this South Asian species is still imported in very large quantities (*cf. antea*, p. 320).

#### ORTOLAN, LAPLAND AND SNOW BUNTINGS

The Ortolan (*E. hortulana*) is almost too regularly reported by

bird observatories nowadays to pass as a "rarity", and it was as well represented in early September 1958 as it was in the corresponding "rush" of two years ago. It has a wide European distribution, including the south and west, and it is interesting to note that its first appearance this year was on the "blind" side of Britain for Scandinavian drift, one reaching Great Saltee off S.E. Ireland on 30th August, with others following there between 3rd and 6th and 11th and 12th September. Also on the 12th an immature bird appeared at Lundy Bird Observatory in the Bristol Channel and another was trapped there on the 23rd. On the 13th there were 4 at St. Agnes in the Scillies, up to 3 remaining till the 24th and one being caught on the 16th. On the east coast, Fair Isle had passage between the 3rd and the 10th, with 3 on the 5th, and a later bird on the 15th-16th (at which time there was also a singleton at Portland, Dorset). The species also turned up at Monks' House on the 3rd, one being trapped, but an influx on the Norfolk coast slightly preceded that at Fair Isle, there being 3 from the 2nd to the 4th at Blakeney, with a later bird on the 8th, when 2 were also seen at Holme. There was one at the Isle of May on the 6th.

In contrast, it was a poor September for Lapland Buntings (*Calcarius lapponicus*) at Fair Isle, there being no more than 7 on any day: the first were seen on the 9th and 13th, and the most on the 25th. By the 13th, however, at least 9 were present on Mullach Mor, St. Kilda, and there were a few September reports from elsewhere (see below). Snow Buntings (*Plectrophenax nivalis*) had September peaks at Fair Isle of 20 on the 13th and 100 on the 26th. They were seen singly at Great Saltee on the 25th and at St. Agnes on the 27th and 1st October, whilst 2 Lapland Buntings were recorded there on the 30th. Lundy, too, had a Snow Bunting on 1st October, preceded by Laplands on the 17th and 21st-22nd September, and again near the end of the month. On the East Coast, there was a Lapland Bunting on the Isle of May on the 6th and single ones were seen coming in off the sea at Cley on the 12th and the 13th; there were 2 or more at Spurn during the last week, and one on Holy Island (Northumberland) on the 29th. In recent years it has been shown that there is a regular movement of Lapland Buntings through the islands off the coast of Co. Donegal (e.g. *antea*, vol. xlvii, pp. 225-226) and on Tory Island this September there was one on the 3rd, 7 on the 6th and 8th, 10 on the 11th and 12th and then a few daily to the 16th.

#### BLUETHROATS

What has been said of the Ortolan applies with even greater force to the Bluethroat (*Cyanosylvia svecica*), except that the number of observations in September 1958 may well have exceeded those of the same month in 1956. The dates of the main influxes were similar to those for the Ortolan, but as none reached the

western observatories we may assume that only Scandinavian birds were involved. Fair Isle began with one on the 2nd and 2 next day, there being as many as 5 on the 4th and 4 on each of the 6th and 8th, with occasional birds afterwards down to the 27th. Simultaneously, arrivals took place in the Teemouth area (Co. Durham), the peak again being the 4th when 3 were present on and near a sea-front bowling-green at Hartlepool. There was one at St. Mary's, near Whitley Bay (Northumberland), 2 on the shore at Aberlady (Midlothian), one trapped at Monks' House (Northumberland), and an adult male caught at Holme (Norfolk), all on the 3rd. Monks' House had 2 birds next day.

None was seen at Spurn Bird Observatory till the 4th, increasing to 3 on the 5th and 4 next day, and altogether 5 were trapped there during the month. A 1st-winter bird was captured at Gibraltar Point Bird Observatory on the 5th, and at Flamborough, Bempton and Redcar (Yorkshire) there were birds on the two following days. The first noted at Cley were 2 on the 8th, and other records come from Stanpit Marshes (Hampshire), where one was netted on the 7th, Shoreham (Sussex) on the 11th, and the Isle of Sheppey (Kent) on the 20th. The Isle of May had Bluethroats on the 6th, 7th, 9th (2), 26th and 27th, but this observatory was not manned during the all-important period of 1st-5th September.

#### THE RARER WARBLERS

We have already mentioned that at least 10 Icterine Warblers (*Hippolais icterina*) were trapped and 4 others seen during September (*antea*, p. 361). The combined total was, in fact, 16. One was trapped at Portland (Dorset) on the 1st, but, with the exception of another at Copeland Bird Observatory (Belfast Lough, Co. Down) on the 14th, they were otherwise confined to the East Coast, as might be expected. Monks' House was visited on the 3rd by a remarkable "rush" of Garden Warblers, with which was a single Icterine, and Fair Isle recorded one on the 4th. There was one with a Wood Warbler (*Phylloscopus sibilatrix*) on this date at Spurn, where others were trapped on the following two days. In Norfolk, one was identified at Holme on the 3rd, with 2 next day; there were 3 or 4 at Blakeney on the 3rd; one was trapped at Cley on the 4th; and there was one at Titchwell on the 6th. Later occurrences were at Blakeney on the 11th, at Kilnsea (E. Yorkshire) on the 13th, and near-by at Spurn next day. This September total of 16 is, it should be remembered, additional to a total of 9 in August: we have already referred to the 5 at Gibraltar Point and the one at Fair Isle in that month (*antea*, pp. 362-364), but we have since learnt that the Isle of May had one on 19th August and 2 on 28th August.

From experience in previous years we have learnt to expect the closely related but more westerly and southerly Melodious Warbler (*Hippolais polyglotta*) to fall along the English Channel and Irish



Sea coasts; and indeed, apart from a probable at Portland on the 3rd, all the September records received are from the western bird observatories. At Great Saltee there were 2 on the 5th, one on the 9th, and 2 over the next two days, one of which was recaptured on the 16th. Skokholm, too, had a bird on the 9th, and the third of the autumn was trapped there on the 21st. Three were caught at Bardsey on successive days, the 5th, 6th and 7th, and 2 unringed "probables" were seen on 8th. Lundy's third-ever record was established on the 10th, and one was trapped at St. Agnes on the 16th. With the August reports already detailed (*antea*, pp. 361-362), we thus have an autumn total for this species of 16 and 6 "probables". Both *Hippolais* species thus played a remarkable part in the 1958 movements, but these numbers also illustrate how systematic trapping, at the bird observatories and elsewhere, is showing that some species formerly looked upon as rare vagrants are more properly regarded as regular drift migrants.

Among other rare warblers, at least 5 Aquatic (*Acrocephalus paludicola*) occurred during the month, the earliest being taken in a mist-net at Coate Water, near Swindon (Wiltshire), on the 2nd. One was found at Great Saltee on the 3rd, and a bird trapped at Fair Isle on the 6th was seen daily till the 10th, and either this or another was present on the 15th. Also on the 6th there was one at Ashlett Creek, Southampton Water (Hampshire). Finally, one was seen in Windsor Great Park (Berkshire) on the 14th. To the August reports of this species, already listed (*antea*, p. 362) should be added one in the garden at St. Catherine's lighthouse (Isle of Wight) on 17th August.

Barred Warblers (*Sylvia nisoria*) were certainly fewer than in the 1956 movement. August reports from Fair Isle, Monks' House, Gibraltar Point and Blakeney Point have already been detailed (*antea*, pp. 364 and 366). In September there was one at Fair Isle during 1st-4th, one or perhaps 2 at Flamborough on the 5th, one at Spurn on the 3rd, one at Holme (Norfolk) on the 3rd, 2 or more at Blakeney during 1st-2nd and 4th-5th, and a late bird at Shellness, Isle of Sheppey (Kent), at dawn on the 28th.

Marsh Warblers (*A. palustris*) were trapped at Great Saltee on the 1st and at Portland on the 3rd. A Reed Warbler (*A. scirpaceus*), very rare in the north, was at Fair Isle between the 5th and 10th (possibly 2 on the 9th), and 2 were trapped at Monks' House on the 3rd, whilst on the 14th Bardsey had its first since 1956. A good Reed Warbler movement took place at St. Agnes between the end of August and 18th September, 4 being ringed, and birds of this species were occasional at Holme (Norfolk) between the 2nd and 9th. Willow Warblers trapped at Monks' House on the 3rd and the 4th included the Northern race *Ph. t. acredula*.

Finally, what was almost certainly an Arctic Warbler (*Phylloscopus borealis*) was watched in a bush at Sands of Forvie,

Aberdeenshire, on 2nd September—another Scandinavian species that, in spite of its south-easterly migration, is not unlikely to take a part in such a September drift.

#### OTHER PASSERINES

The unprecedented passage of Tree Sparrows (*Passer montanus*) at Fair Isle in spring and autumn 1958 has been mentioned previously (*antea*, pp. 238, 364): it is doubtful if there was any further influx after 5th September, when 11 were counted (after 7 on the 3rd), but numbers varied to the 25th, with 10 observed on the 10th and the 14th. At Shellness, Isle of Sheppey, there was strong passage of Tree Sparrows coming in off the sea from the east, and continuing west, between 21st and 24th September, the most being over a hundred on the 22nd.

A strong Tree Pipit (*Anthus trivialis*) passage was a marked feature of the early September drift, as in 1956: in Ireland, where this is an uncommon migrant (*antea*, vol. L, pp. 424-432), there was a sprinkling at Great Saltee between the 7th and 12th and as many as 9 on the 14th, with a few also later. Meadow Pipit (*A. pratensis*) passage, incidentally, was immense at St. Kilda in mid-month, and on the 15th-16th it was estimated that about 7,000 birds were present on the main island, Hirta. Migration of this species was also strong in Ireland, particularly Co. Kerry, and it is interesting to note that a number of exhausted birds took refuge on the ocean weather-ship at station "India", near latitude 59°N. and longitude 19°W., between the 2nd and the 9th. White Wagtail (*Motacilla a. alba*) passage, too, was stronger in Ireland than for many years, and was described as "spectacular" at Bardsey; *flava* wagtails occurred daily at Saltee during the 9th-18th, whilst there was good passage during the 25th-28th at Portland. Three Blue-headed Wagtails (*M. f. flava*) put in an appearance at St. Agnes as late as 2nd October, and there had been full-plumaged birds of this race at Marazion Marsh (Cornwall) on 10th September and at Fair Isle on the 25th. A Yellow Wagtail (*M. f. flavissima*) was at Foula (Shetland) on 27th-28th August and another at Tory Island (Co. Donegal) on 7th September. Passage of Grey Wagtails (*M. cinerea*) was a strong feature of the September movements at Hilbre Island in the Dee Estuary (Cheshire), and birds in E. Yorkshire at the beginning of the month and at the Isle of May on the 9th, 15th, 20th, 23rd and 27th may have been concerned in the drift at that time.

A few Tawny Pipits (*Anthus campestris*) were recorded in the south-west, where there was one at St. Agnes on the 10th and another on the 16th, with one at Great Saltee two days later. One came in off the sea at Portland on the 11th, and this bird observatory recorded its third of the autumn (*cf. antea*, p. 362) on the 28th—and then had 3 more on the 30th, and another 3 on 2nd October! A Water Pipit (*Anthus s. spinoletta*) was observed there on 2nd September.

There were half-a-dozen Firecrests (*Regulus ignicapillus*) at Portland on the 28th, the movement continuing into October, whilst a few appeared at Dungeness. A Golden Oriole (*Oriolus oriolus*) was identified near Tambridge (Essex) on the 9th, and extra limital Nighthingales (*Luscinia megarhynchos*) appeared at Monks' House on the 2nd and at Great Saltee on the 8th (where what was apparently the same bird was still present on the 13th). A Woodlark (*Lullula arborea*), an uncommon bird there, visited Fair Isle on the 20th.

#### OTHER LAND-BIRDS

Two Northern Pied Woodpeckers (*Dendrocopos m. major*) must have found Fair Isle an inhospitable staging-point on the 3rd and the 22nd; nevertheless one, the same ringed bird, stayed from the day of its capture on the 6th until the 28th. Nightjars (*Caprimulgus europaeus*) were trapped at Lundy on the 9th and 16th, and an Alpine Swift (*Apus melba*) visited Great Saltee on the 14th-15th. Foula in Shetland had a young Cuckoo (*Cuculus canorus*)—perhaps a local bird, as annual breeding in these islands is suspected—on the 6th, and a late youngster was at Spurn on the 13th-14th. Three Bee-eaters (*Merops apiaster*) flew northwards over Gibraltar Point on 2nd September, and there was an adult with Starlings at Loughborough sewage-farm (Leicestershire) on the 13th. Rollers (*Coracias garrulus*) were reported from opposite ends of the British Isles: one at Mid Yell (Shetland) on 5th September was successfully warding off a Kestrel by turning on its back in mid-air and presenting its claws; and one at St. Mary's in the Scillies flew across the island from east to west, landing periodically, on the 22nd; another was seen to come in off the sea at Bamburgh (Northumberland) on the 24th.

There was a veritable crop of Hoopoes (*Upupa epops*) in August and September: August records have been given (*antea*, p. 364); the September ones were mainly in the south and south-west, with a sprinkling up through the Midlands as far north as Lancashire and Perthshire. Dungeness had one on the first two days of the month, Hayling Island (Hampshire) one on the 2nd, Rye Harbour (Sussex) one on the 3rd, and on the 4th a bird appeared at Stafford. Portland reported 2 on the 3rd and singletons on the 4th and the 6th, and at St. Agnes there were several between the 2nd and the 20th. One reached Skokholm on 6th September, whilst birds visited Lundy from the 8th to the 10th and again on the 14th. A second at Sandwich (Kent)—where there had been a bird on 30th August—made an eight days' stay from the 10th, and one seen on a lawn at Blakeney (Norfolk) on the 11th is said to have been in the area since the 5th.

A further influx of Hoopoes took place later in the month, one appearing near Weston-super-Mare (Somerset) some days before the 20th, from which date a bird haunted the shore at Kilmore

Quay (Co. Wexford) and watched the coming and going of ornithologists to Great Saltee! There was a bird at Brentwood sewage-farm (Essex) on the 23rd, and another on the Fleetwood golf-links in Lancashire on the 28th. In Devon there were 2 near Plymouth at the end of September and one on Dawlish Warren on 4th October, and in Cornwall one spent the last week of September in a garden at Calstock. Right up in Scotland one appeared at Aberfeldy, Perthshire, on 30th September, was caught in poor condition on 3rd October and died on the 5th.

#### WRYNECKS

A great feature of the early and mid-September movements was the frequent and widespread occurrence of Wrynecks (*Jynx torquilla*). They first appeared in the north and all along the east coast, and did not enter the Irish Sea until eleven days later: the almost perfect coincidence of their arrivals and peaks in the two regions is well seen from the chronological list of reports below:

- 2nd: First appearance at Fair Isle (Shetland), Monks' House (Northumberland), Spurn Point (Yorkshire), Gibraltar Point (Lincolnshire) and Blakeney (Norfolk).
- 3rd: Increase to 2 or 3 birds at Fair Isle, Monks' House, Spurn and Gibraltar Point. One ringed on Foula (Shetland). One died, exhausted, and another seen at Hartlepool (Co. Durham). In Norfolk, several at Blakeney until the 5th, and 2 at Holme.
- 4th: Peak of 4, Fair Isle. One found dead, Foula. One at Whitley Bay (Northumberland). Peak of 6, Spurn. Still 2 or 3, Gibraltar Point area. Peak, perhaps as many as 10, Blakeney. One trapped at Dungeness, and one at Shellness, Isle of Sheppey (Kent).
- 5th: One at Port Clarence (Co. Durham). At Flamborough (E. Yorkshire) 2 or 3 were about till the 7th. Spurn, 8. Gibraltar Point, 2 trapped. Sandwich Bay (Kent), one trapped, stayed till the 13th. Southwold/Walberswick (Suffolk), 2 seen.
- 6th: 2 at Fair Isle, after one the previous day. Teesmouth (Co. Durham), one. Spurn, still 8. North Cotes (Lincolnshire), one trapped. Isle of May (Firth of Forth), 2, and 1-2 until the 11th (this observatory not manned during 1st-5th).
- 7th: Kilnsea coast (E. Yorkshire), one dead. Spurn, 6 (10 birds trapped in the week!). Holme, one.
- 8th: Blakeney, 3 (also on the 9th). Portland Bill (Dorset), one trapped, stayed till the 10th. Walberswick (Suffolk), one dead on road.
- 10th: Sandwich Bay, 2. Tory Island (Co. Donegal), one.
- 12th: Gower Peninsula (Glamorgan), one.
- 13th: St. Agnes (Scilly Is.), one trapped. Great Saltee (Co. Wexford), one trapped. Skokholm (Pembrokeshire), one trapped, stayed 5 days and increased its arrival weight by 10 gm.! Blythburgh (Suffolk), one dead on road.
- 14th: St. Agnes, one trapped (subsequently a singleton on most days until the 24th). Portland Bill, one trapped. New Balderton (Nottinghamshire), one in a garden.
- 15th: Great Saltee, one trapped (one also seen on the 19th).

It would be most interesting to add to this list, which must be very incomplete, as a clear-cut pattern of immigration seems to emerge, and we would be glad to hear of any other records. It is known that Wrynecks were seen at various Essex localities

during the first part of the month, but we do not have the actual dates.

#### SHRIKES AND TURTLE DOVES

Red-backed Shrikes (*Lanius cristatus*) seem to have been rather less frequent over the period, but they were equally widespread, and also reached the Irish Sea observatories. There were one or 2 daily at Fair Isle for the first ten days and, at the other end of Britain, St. Agnes had 3 or more on the 6th and between the 13th and the 19th. Like Fair Isle, Monks' House and Spurn recorded them from the beginning of the month, with 3 each on the 2nd and singletons at Monks House on the 1st, 3rd and 4th, and at Spurn on the 5th and 7th. There was one in this period at Sutton-on-Sea (Lincolnshire), and 2 on the 4th-5th at Gibraltar Point. What may have been the same juvenile was present at Portland from the 3rd till the 18th. One was caught at Holme on the 4th and single birds were seen at a number of places in Norfolk and Suffolk. Two were seen at Crimdon Dene (Co. Durham) on the 6th, and a juvenile trapped at Dungeness on the 7th remained until the 10th. Birds were noted at Sandwich on 30th August and 5th and 10th September. In the Irish Sea, Lundy had immature birds on the 1st and 15th-16th, and at Great Saltee (where this species is regarded as rarer than the Woodchat) birds appeared singly from the 9th to the 12th, the 14th to the 16th and on the 26th, the last a very greyish-looking juvenile.

Lundy recorded Woodchat Shrikes (*Lanius senator*) on 30th August and during 1st-4th September, whilst Great Saltee had a single Woodchat on the 3rd-4th and no fewer than 3 on the 6th. Juvenile Woodchats also visited Portland and St. Agnes Bird Observatories on the 14th. Earlier, a Woodchat arrived at Bleabury Down, Berkshire, on 14th August and stayed until 6th September (*cf.* August reports, *antea*, p. 362). Later, in October, one was ringed at Portland on the 7th and stayed until the 23rd, and a young bird appeared at Portslade (Sussex) also on the 7th, disappearing on the 9th.

The first Turtle Dove (*Streptopelia turtur*) of the month at Fair Isle was on the 1st and there were 2 next day, with 3 from the 5th to the 9th. Birds were at Bardsey Bird Observatory on the 2nd, 4th and 10th, and there was one at Tory Island (Co. Donegal) on the 4th. One was at Spurn on the 6th, and at Great Saltee there was steady passage throughout the first week, with 3 from the 3rd to the 5th and 5 on the 6th. A bird far out of its normal range took refuge on the weather-ship at station "India", some 200 miles south of Iceland and 300 miles west of the Faeroes, on the 12th: it was still aboard at dusk, but disappeared during the night. Another movement in mid-month brought 3 different birds to Great Saltee between the 14th and the 19th, and at Portland 3 on the 15th were followed by 5 on the 18th. A big "rush" of some 70-80 birds daily developed there on the 19th-20th,

dropping to 50 on the 21st; and a mere trickle between the 25th and 27th was reflected in a small passage of 7 at Dungeness.

#### RAPTORS

The most interesting single bird-of-prey was undoubtedly the immature Red-footed Falcon (*Falco vespertinus*) at Holme (Norfolk) between 7th and 16th September (not identified until the 14th). As a migrant, however, the Osprey (*Pandion haliaëtus*) achieves more importance, the August occurrences (*antea*, p. 362) being followed by no fewer than nine in September. A bird which came aboard a Humber pilot-boat, east of Spurn, early in September had been ringed 45 km. west of Stockholm, Sweden, on 8th July 1958. There were others at Faversham (Kent), on the 6th and 8th, and at Shardeloes Lake, Amersham (Buckinghamshire), on the 6th. Another stayed about the King George V Reservoir (Essex) for the first three weeks of the month, and 2 on the River Camel near Wadebridge (Cornwall) remained from the 7th to the 15th, while one was watched on the River Exe (Devon) on the 9th. There was an immature fishing the Emsworth Channel at Hayling Island on the 14th, and others were seen at the Isle of Sheppey (Kent) on the 14th, and over a built-up area at Salisbury (Wiltshire) on the 24th. At the beginning of October an Osprey appeared at Darwell reservoir, north of Hastings (Sussex); and another was reported from two localities in the vicinity of Broseley (Shropshire)—at Willey Park during 4th-9th and at Acton Burnell Park (eight miles west) on 11th and 12th.

A female Goshawk (*Accipiter gentilis*) was watched at Pilot Hill (Hampshire)—not far from Newbury (Berkshire)—on 3rd September.

#### RUFFS AND OTHER WADERS

In an earlier summary (*antea*, p. 367) we remarked that the August passage of the less abundant waders was in no way remarkable, except that certain species were said to be commoner on the South Coast. However, Ruffs (*Philomachus pugnax*) certainly took part in the September movements, and their abundance in Ireland at this time was little short of phenomenal for that country. There were over 70 in one locality in Co. Wexford about the 10th-11th, with smaller lots on the North Slob and near Rosslare, and they were well represented among the waders at Lough Akeagh in Co. Kerry; there were even 4 at Tory Island (Co. Donegal) on 9th September, decreasing to the 11th and one on the 18th. Farlington Marshes (Hampshire) reported "biggest ever" numbers (15 on the 11th, 16 on the 14th-15th, and 13 on the 24th), and at Marazion Marsh and the Hayle Estuary (Cornwall) observers tallied the highest counts ever for the county (21 on the 11th, 28 on the 12th, and 10 on the 13th-14th). They were said to be late on the lower Humber saltings (E. Yorkshire), arriving there and at Spurn on the 1st and the 4th respectively, with

increased numbers on the 11th-12th at the first locality and 8 on the 16th. During this first fortnight there were 23 at Nottingham Sewage Farm and a bigger-than-usual passage at Fair Isle, with 11 on the 5th, 15 on the 9th and almost as many on the two following days, when there was a sharp decline followed by a rise to 11 on the 13th. Lundy had 9 birds on the 9th—only the third occurrence at this observatory—and others on the 11th, and Skokholm also did remarkably well with 6 on the 3rd and 11 next day, followed by 5 on the 11th and a flock of 14 passing south on the 13th; a Reeve at Bardsey on the 18th was the first for that island.

Wood Sandpipers (*Tringa glareola*) were also more noticeable in Ireland than in former years. They and Green Sandpipers (*T. ochropus*) were linked with the main drift influxes, but records are, of course, too numerous to detail. Spotted Redshanks (*T. erythropus*) on Foula on 27th-28th August and 2nd September, and at the Isle of May on the 17th, are probably first records for these islands; and again there was a good sprinkling in Ireland, in Cos. Cork, Waterford, Wexford, Kerry and elsewhere. At Fair Isle, Little Stints (*Calidris minuta*) had some part in the early drift, with 4 arriving on the 2nd.

Temminck's Stints (*C. temminckii*), after only three reports in August (*antea*, p. 367), appeared in at least six places in September: at Havergate (Suffolk) on the 4th-5th; at Wisbech sewage-farm (Norfolk/Lincolnshire) from the 9th to the 12th; at Sandwich Bay (Kent) on the 11th; at Windmill Creek (Kent) and Nottingham sewage-farm on the 21st; and at Walton sludge lake (Lancashire) on the 23rd. Curlew Sandpipers (*C. testacea*), as already mentioned (*antea*, p. 367), remained extremely scarce throughout the autumn—though there was a little crop of reports of single birds at the beginning of October.

Two Avocets (*Recurvirostra avosetta*) at Salthouse (Norfolk) during 4th-6th September are worthy of note; and one at Shellness, Isle of Sheppey, on the 11th and 12th recalls the fact that part of Kent is now a regular wintering-area for this species. A Dotterel (*Charadrius morinellus*) visited Lundy on 21st August and there were 2 more there on 8th September. At Portland there were 2 on the 3rd increasing to 5 on the 5th, on which date 2 were also seen at Sand Point near Weston-super-Marc (Somerset).

With the exception of the American species (see below), the only rare waders during September were Black-winged Stilts (*Himantopus himantopus*). One was seen at Cooden Beach (Sussex) on the 15th and single birds were reported from two localities in the vicinity of Rye (Sussex) on a number of dates between 20th September and 5th October. On two occasions between 20th and 26th September 2 were seen together at one of the Rye area localities. (An August occurrence in Norfolk has already been mentioned, *antea*, p. 363.)

## OTHER WATER BIRDS

One of the most exciting visitors to the south was the Black Stork (*Ciconia nigra*) that was first seen at Stone Cliff (Sussex) on 7th August and moved thence via Icklesham to Iden, all three localities being not many miles from Rye; at Iden it settled down and, though wary, was watched by many people until 14th September. An immature Little Bittern (*Ixobrychus minutus*) was reported from the Bristol Avon above Keynsham (Somerset) on 28th September: it should be remembered that this is not the first Somerset occurrence this year (*cf. antea*, pp. 320 and 362). Several Spoonbills (*Platalea leucorodia*) were seen in southern coastal localities during September: one on the 5th and 2 on the 6th at Sandwich Bay (Kent); one during 5th-13th at Cley (Norfolk); 3 flying west early on the 18th at Hove (Sussex) and one on the same day at Abberton reservoir (Essex); and an immature during 20th-27th September and on 4th October at Stanpit marshes (Hampshire). But more remarkable was the appearance of 5 Spoonbills at Ainsdale, near Southport (Lancashire), on 6th October: the group dwindled to 4 (all immature) and then to 2, which finally left on 11th October (the only previous occurrences of Spoonbills on the north-west coast of England have been of single birds).

A slightly early influx of Red-necked Grebes (*Podiceps griseigena*) at the end of September is suggested by the coincidence of dates of reports from Hove (Sussex) on the 21st, Pett pools (Sussex) during the 22nd-28th, Queen Mary reservoir (Middlesex) on the 24th, and Freshfield (Lancashire) on the 28th.

## SEA-BIRDS

There was an early Glaucous Gull (*Larus hyperboreus*) at Monks' House on 31st August, and the Iceland Gull (*L. glaucoides*) which disappeared from Southwick and Shoreham (Sussex) in June (*antea*, p. 282)—a bird with a lame leg—returned to its old haunts on 24th September. Another, in the white immature plumage, which frequented an area just outside Inverness between 20th October 1957 and mid-May 1958, returned to the same place on 12th September and was still there at the end of October. A Caspian Tern (*Hydroprogne caspia*) was reported at Mudeford (Hampshire) on the 7th and a Gull-billed Tern (*Gelochelidon nilotica*) from the Channel Islands on the 16th. A strong movement of Roseate Terns (*S. dougalli*), with a peak of over 300 birds, took place past Great Saltee between 2nd and 5th September, together with some 400 Sandwich (*S. sandvicensis*) and many Common/Arctic Terns (*S. hirundo/macrura*).

The main numbers of Black Terns (*Chlidonias niger*) passed in late August (*antea*, p. 367), and although the September sightings show a fairly wide scatter, the numbers concerned are very small. A dozen passed by Skokholm on the 8th, the first record for the



island, and a party of over 20 at Shanagarry Pools, Ballymona (Co. Cork), on the same day is worthy of record in view of the scarcity of this species in Ireland. A juvenile White-winged Black Tern (*Chlidonias leucoptera*) was watched by many people at Wisbech sewage-farm, on the Norfolk/Lincolnshire borders, from 21st September until at least 5th October. Reports of Balearic Shearwaters (*Procellaria puffinus mauretanicus*) continued to come from Portland (*antea*, p. 368): there were several in the earlier part of the month, mostly on the three days 10th-12th September, with 11, 25 and 40 respectively; there were also 10 on the 19th and 6 on the 28th, including birds of the *yelkouan*-type. One was seen off Great Saltce on the 4th, and watchers at Land's End, Mounts Bay and St. Ives (Cornwall) reported them on a number of days, the best of which were the 14th with 29 and the 25th with 7.

#### AMERICAN BIRDS

The second half of September onwards produced a number of reports of American birds (*cf. antea*, p. 363), as well as an influx of phalaropes (*Phalaropus* spp.) and some Sabine's Gulls (*Xema sabini*). It is hoped to deal with these in a special analysis and so we are confining ourselves here to brief mention of the American species involved. These were, up to mid-October, one Buff-breasted Sandpiper (*Tryngites subruficollis*), one Lesser Yellowlegs (*Tringa flavipes*), one Dowitcher (*Limnodromus griseus*), 3 White-rumped Sandpipers (*Calidris fuscicollis*), some half-dozen Pectoral Sandpipers (*C. melanotos*) and a Baldpate (*Anas americana*)—as well as 2 most interesting American land-birds.

St. Agnes Bird Observatory (Scilly Isles) trapped a Northern Waterthrush (*Seiurus noveboracensis*) on 30th September and two days later Lundy Bird Observatory emulated this by catching a female Baltimore Oriole (*Icterus galbula*). Both are migratory species with fairly wide breeding ranges in North America—in fact, the Waterthrush, which is not a thrush at all but one of the American wood warblers (Parulidae), nests as far north as Alaska and Newfoundland—and both winter in Central and northern South America. There is one previous European record of the Waterthrush (Ushant, France, September 1956) and the Baltimore Oriole is considered by some to have occurred wild in Britain on one previous occasion—in Shetland, 26th September 1890 (*antea*, vol. xlviii, p. 13)—but it is still officially rejected because of the frequency with which this species was imported as a cage-bird at that time. This year's Baltimore Oriole (trapped at 16.00 hours on 2nd October and still present on the 4th) weighed only 27 gm., which suggests a loss of at least 20-25% of its normal weight (see discussion *antea*, vol. xlvi, p. 367); the Waterthrush (which stayed until 12th October) was, unfortunately, not weighed.

# “RECENT REPORTS AND NEWS” AND THE FORTHCOMING “BIRD MIGRATION” BULLETIN

## A Joint Statement by the Editors of “British Birds” and the President of the British Trust for Ornithology

Owing to the present-day complexity of ornithological data there has been a growing tendency for publication to lag far behind the event, and it has become increasingly difficult to follow what is going on at the time.

The remarkable response to the *British Birds* feature giving an up-to-date and country-wide account of the happenings of the preceding month has shown the deeply-felt need for such a service and how much it is appreciated. The mere fact of presenting news in this way has encouraged observers to send in information promptly. It seems, too, that more is now put on record and less is buried or forgotten. The accounts of rarities are more valuable in their proper context of the movement of other species, and bird observatories, other groups and individuals can all play their part in achieving this by providing regular news of both common and rare birds. The collaboration of all these sources should permit a more balanced and more nearly complete picture than has previously been possible.

Another recent development has led to joint action between *British Birds* and the British Trust for Ornithology. Towards the end of last year the Trust obtained a grant from the Nuffield Foundation to appoint a full-time research worker to collate the migration data from the bird observatories, to advise on the standardization of methods of keeping records and to co-ordinate future migration studies in this country. Kenneth Williamson, formerly the director of Fair Isle Bird Observatory, was appointed by the B.T.O. as Migration Research Officer for a period of five years from 1st January 1958, and is now operating from the Trust office at 2, King Edward Street, Oxford. His first tasks have been to arrange for the copying of all the more important data from the observatories for past years, in order to establish a permanent central record which will be kept up-to-date, and to prepare a paper on the exceptional drift-movements that took place in September 1956 and affected many parts of the country. In view of the more recent, and equally notable, events of September 1958, outlined in “Recent reports and news” above, he is taking the opportunity to analyse in one paper the two periods and their associated weather. Analyses of this nature may appear in future in any existing scientific journal or in a new bulletin to be called “Bird Migration”, which will be produced twice a year by the B.T.O. and of which fuller details will be given later.

The complementary nature of the two developments—the migration research programme and the “Recent reports and news”—and the possibility of each helping and amplifying the scope of the other, gave rise to the spontaneous co-operation of all the observatories and to the collaboration of Kenneth Williamson as joint author with I. J. Ferguson-Lees of the “Recent reports and news” feature. This extension of co-operation between the editors of *British Birds* and the B.T.O. is very welcome to both parties. It has been agreed that in future *British Birds* will handle the news aspects as promptly as possible, and the B.T.O. through their Migration Research Officer, will undertake responsibility for periodical considered analyses (including weather maps) and interpretation of the movements recorded not only at observatories, but throughout the country. It is intended that such special events as “invasions” of Crossbills (*Loxia curvirostra*) or “wrecks” of Leach’s Petrels (*Oceanodroma leucorhoa*) will continue to be summarized in *British Birds*.

All non-confidential information received by *British Birds* in connection with “Recent reports and news” will be available to both bodies, and there will be

no need for contributors to duplicate it to the B.T.O. Migration Research Officer, who may, however, contact them direct for further details if required for his own research.

The generous grant to the B.T.O. from the Nuffield Foundation will provide us with a great opportunity in future to study migration phenomena while they are still fresh in our minds. Kenneth Williamson will also be taking advantage of the new facilities to make a full investigation of the characteristics of differing populations of particular species, and to attempt a revision in the field of our knowledge of the measurements, weights and taxonomic characteristics of birds.

## REQUEST FOR INFORMATION

**The winter status of the Eider and the Long-tailed Duck.**—In recent years there appears to have been a significant southward spread by Eiders (*Somateria mollissima*) in Britain in winter, and this is possibly connected with an increase and very much smaller spread in the breeding population. Mr. J. H. Taverner is making a study of the apparent changes for us and we should be grateful if any relevant information that has not appeared in county bird reports could be sent to him at 123 Kingsway, Chandler's Ford, Hampshire. Data needed include information on (i) breeding and winter status in the north and winter numbers in the south, especially where comparative details are available to show whether there has been any recent change; (ii) possible explanations for changes in numbers or distribution; and (iii) the sex/age composition of winter flocks, again compared with earlier figures (if available).

Coincident with the spread of Eiders, there has been a much smaller increase in Long-tailed Ducks (*Clangula hyemalis*) wintering in southern England (*antea*, pp. 40, 208, etc.) and Mr. Taverner is also collecting information on this species. Here the essential information is (i) in the south, unpublished records over the last ten years; and (ii) in the north, data on any recent changes in the numbers of wintering birds.

We hope that interested readers will help by contacting Mr. Taverner.

## LETTERS

### THE DISTRIBUTION OF THE FRIGATE PETREL

SIRS,—I have always turned with interest to the text which accompanies the invariably excellent "Photographic studies of some less familiar birds". As a rule the letter-press can be relied upon to be accurate. In your issue for July 1958, however, the author of the article on the Frigate Petrel (*Pelagodroma marina*), Mr. John Warham, appears to be unacquainted with the literature about this bird before 1933 (judging from his list of references) and also inaccurate in quoting what he has read. Referring to the two British-taken examples, the statement appears (p. 269): "Both these birds belonged to the race *hypoleuca* which nests on the Salvages, the Cape Verdes and the Canary Islands in the north Atlantic". Then (p. 270) we read: "At the Canary and Madeira Islands in the north Atlantic the species also breeds in the (northern) summer . . . .". And a few lines further on Dr. W. R. P. Bourne is quoted as suggesting "that these colonies are relicts isolated by a subsequent climatic warm-up which has made possible the development of summer-breeding populations in the Madeira and Canary groups . . . .".

Let me state here that the Frigate Petrel has *never* bred in the Canary Islands: I made that fact abundantly clear in 1914 (*Ibis*, 1914, pp. 461-465). Further, it is only an accidental visitor to Madeira—very few records having been obtained from Madeiran waters, even by Padré Schmitz. It does not breed on the Desertas or on the main island, nor is it found on Porto Santo. The only breeding place of the Frigate Petrel in the north Atlantic, other than the Cape Verde Islands, is on the Salvage Islands, which by no stretch of the imagination can be included in either the Madeira group or the Canary Archipelago. *P. m. hypoleuca* was certainly first described from Teneriffe, but it is only a straggler to Canarian seas. The latest list of "The breeding birds of the Canary Islands" (*Vidensk. Medd. Naturh. Foren. Kbh.*, 113, 1950, pp. 1-151) makes no mention of any recent discovery, and it will be seen by consulting *The Handbook* that the late F. C. R. Jourdain, after quoting the breeding range, adds that it has "occurred in the Azores, Canaries, Madeira, and off the coast of New Jersey".

I stand to be corrected if the editors of *British Birds*—to whom we look for strict accuracy—can supply chapter and verse for any breeding records of *Pelagodroma marina hypoleuca* in any of the islands of the Madeira or Canary Archipelagos.

DAVID A. BANNERMAN

[We regret this error and print below Mr. Warham's comments in reply to Dr. Bannerman's criticisms.—Eds.]

SIRS,—Dr. Bannerman is, of course, quite right. It was gross carelessness on my part to state that the Frigate Petrel breeds on the Canaries or Madeira and to suggest that Dr. Bourne's papers indicate this. When the article was being written I was also checking the data on the distribution of the Little Shearwater (*Procellaria baroli*) in the north Atlantic and it is obvious that my notes on these two species were reversed. In the last sentence of the first paragraph of my article (p. 269) "Canary Islands" should therefore be deleted, while both references to "Canary and Madeira Islands" in the fifth paragraph (p. 270) should be replaced by "the Salvage Islands".

JOHN WARHAM

#### "THE BIRDS OF SUFFOLK"

SIRS,—I am at present engaged on the preparation of a new work on the birds of Suffolk, and should be very grateful if those of your readers who have any relevant notes or records would kindly send them to me at Hartest Place, Bury St. Edmunds, as soon as possible. Suitable acknowledgement will of course be made.

Records for the years 1932-1950 would be particularly welcome, as this covers the period between the publication of C. B. Ticehurst's *A History of the Birds of Suffolk* and that of the first *Suffolk Bird Report*. On the other hand, records which have already been published in any of the *Suffolk Bird Reports* should not be sent.

WILLIAM H. PAYN



## SMALL ADVERTISEMENTS

**BINOCULARS AND TELESCOPES.**  
New and used. Descriptive lists and expert advice on request. Exchanges, overhauls. J. R. Hebditch, F.B.O.A., S.S.M.C., 44 Hallgate, Doncaster.

**EDGE OF BRITAIN.** Unique colour film of Shetland Bird Life. Brochure gladly sent, on request to West Country Film Distributors, 73/74 Boutport St., Barnstable, Devon.

**BINOCULARS AND TELESCOPES,**  
new and reconditioned, at reasonable prices. Approval allowed, also part exchanges. Lists from Hatton Optical Co. Ltd., Lansdowne, Bournemouth, Hants. (Established 1930).

**WANTED**—Copies of *British Birds* for MAY 1957 are still needed by the publishers, who will pay full price and postage for any in good condition.

< 40 Wrayvu Binocular £18/18/0,  
exchanges, repairs, lists. Bass & Bligh, 6, Market Arcade, Leeds 1.

**WANTED**—*British Birds*, 1954-1956 inclusive, bound. Slyfield, 47 North Parade, Horsham, Sussex.

**BIRD MIGRATION**—A Bulletin of the British Trust for Ornithology, edited by Kenneth Williamson, to be published twice a year. No. 1, ready end of December, will contain short reports from all the Bird Observatories for autumn 1958 and analyses of interesting movements. Copies 2/6 post free; order with remittance from Business Editor, B.T.O., 2 King Edward St., Oxford.

**BINOCULARS AND TELESCOPES,**  
repaired, cleaned and adjusted; send your instrument for estimate by return. Hatton Optical Co. Ltd., Lansdowne, Bournemouth, Hants.

**FOR SALE**—*Handbook of British Birds* (Witherby, Jourdain, Ticehurst, Tucker), 5 vols., 1st ed., original paper covers; £6 or near offer. Apply Gotch, 22 Chepstow Road, W.2.

**SPEND YOUR HOLIDAYS IN A  
BIRD WATCHERS' PARADISE**

### PLACE MANOR

nestling in the lush Sub-Tropical vegetation of St. Anthony-in-Roseland, on the edge of lovely Percuil Creek, with its own five safe sandy bathing beaches. This peaceful spot outside world has never known; a haven of rest for countless numbers of our birds. Sightings last spring: Hoopoe, Little Egret, and Purple Heron.

Open all the year round. Ideal for a winter holiday: **THERE IS NO REAL WINTER IN ROSELAND.**

Terms from £5 5s. per week, all inclusive. Write for Illustrated Brochure to O. Harte, Place Manor, St. Anthony-in-Roseland, Portscatho, Cornwall. Phone Portscatho 256. Enclose 3/4-sized stamped addressed envelope.

**ON THE GLORIOUS  
CORNISH COAST**

## ZOOLOGICAL RECORD

### SECTION AVES 1957

The **Aves** section of the *Zoological Record*, the only comprehensive bibliography published annually of ornithological literature, is an indispensable work of reference for those desiring knowledge of the world's literature on recent research and developments in the study of birds.

Compiled by Lt.-Col. W. P. C. Tension, D.S.O., the current issue documents references to nearly 2,400 articles and books appearing mainly in 1957, of interest to ornithologists.

Obtainable from the publishers, Zoological Society of London, Regent's Park, London, N.W.1., England. Price 10/5d. post free.

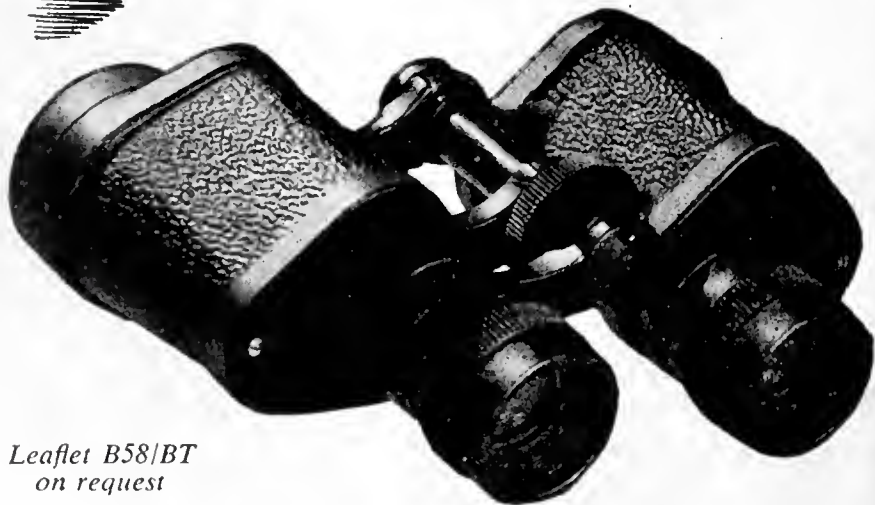
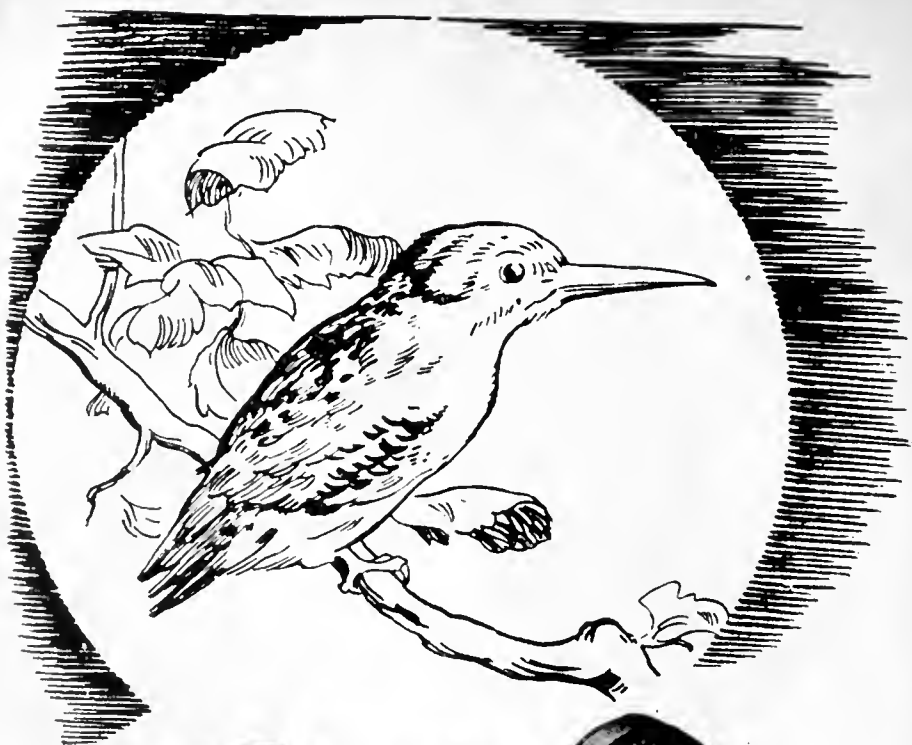

*Leaflet B58/BT  
on request*

Types C.F.18 and C.F.24 ( $8 \times 30.5$  mm.) are highly favoured by bird-watchers, C.F. 24 having an extra wide field of view which is particularly valuable for observing birds in flight. With those who prefer a higher magnification, type C.F.43 ( $10 \times 42$  mm.) is a firm favourite.

# *Binoculars by* **BARR & STROUD Ltd.**

ANNIESLAND, GLASGOW, W.3 — London Office: 15 Victoria St., S.W.1

*Printed in Gt. Britain by WITHERBY & CO., LTD., WATFORD, HERTS.  
Published by H. F. & G. WITHERBY, LTD., 5, WARWICK COURT, W.C.1.*

# BRITISH BIRDS



SUPPLEMENT 1958

THREE SHILLINGS

*Bird-Ringing Number*

CONTENTS OF VOLUME LI, 1958, BIRD-RINGING NUMBER

---

Report on bird-ringing for 1957. By Robert Spencer ... .. 449

British recoveries of birds ringed abroad. Communicated by Miss  
E. P. Leach ... .. 487

---

List of bird observatories in the British Isles, the addresses of their  
organizers, and their accommodation charges ... .. *Inside back cover*

A brief history of bird-ringing in the British Isles ... .. *Outside back cover*

---

Cover photograph by G. K. Yeates: Little Grebe (*Podiceps ruficollis*) on nest.





BOUGHT  
29 DEC 1958

## BRITISH BIRDS



### REPORT ON BIRD RINGING FOR 1957\*

By ROBERT SPENCER, B.A.  
(Secretary, Bird-Ringing Committee of the  
British Trust for Ornithology)

THE CONTINUOUS INCREASE in the number of recoveries recorded yearly has so far been marked by a corresponding increase in the length of the annual "Report on bird-ringing", those for 1955 and 1956 each occupying three-quarters of an issue of *British Birds*. That this appropriation of additional space could not continue indefinitely will be apparent to all, but thanks to the generosity of the publishers, it has now been found possible to produce a special "ringing" number, supplementary to the regular monthly issues of *British Birds*, but included in the main pagination and fully cross-referenced in the annual index of the magazine. This cannot, of course open the way to unlimited expansion, but the additional space now available has enabled us to bring the complementary report "British recoveries of birds ringed abroad", hitherto published separately, within the same covers, and at the same time to increase slightly the length of the main report.

The total of birds ringed in 1957—186,346—represents an increase of more than forty thousand over the figure for 1956, and well in excess of a million and three-quarter birds have now been ringed since the inception of the scheme. For the first time in many years there was a substantial rise in the number of birds ringed as nestlings, the total falling not far short of 50,000. As will be seen from Table II, however, this was largely because more colonial sea-birds were ringed than in previous years. Over three-quarters of the annual increase was of trapped Passerines, a result due partly to an increase in the number of ringers, partly to further imports of mist-nets. The full impact of these nets has yet to be felt, however, for supply has remained much below demand, but their versatility and effectiveness is reflected in the high ringing totals for Swifts, Swallows and House Martins, and in the wide variety of waders now being handled annually. Jack Snipe, newly promoted from the second to the first division of Table II, must soon be followed by half-a-dozen other species of waders. A similar

\* This is the twenty-first report issued on behalf of the Bird-Ringing Committee, and is a publication of the British Trust for Ornithology. For the twentieth report see *British Birds*, vol. L, pp. 449-485.

promotion, partially attributable to the nets, and a milestone in the progress of trapping, is that of the Barred Warbler, the first of the rarer warblers to reach a century.

New species added to the ringing list during 1957 were Black-throated Thrush, Thrush Nightingale and Lanceolated Warbler, all at Fair Isle, and Summer Tanager (*Piranga rubra*) on Bardsey. With these additions 275 species have now been ringed in the British Isles. This year the final step has been taken in removing races from Table II. Ringers, now able to catch passage juvenile "alba" and "flava" wagtails on a large scale, frequently find it impossible to determine the race with any certainty, and rather than ascribe them to the British race, on the grounds of probability, it is clearly preferable, so far as published totals are concerned, to deal only at species level. This has long been the practice with many races: British and Continental forms of Song Thrush, Dunnock and Robin, for example, have always been "lumped" in this manner.

In all, 5,497 birds were recovered during 1957, this being an increase of 689 over the previous year's total. The small proportion of them winning a place in the published list (about one in thirteen) therefore represents the cream, but even among these some stand out as being of unusual interest. If recoveries in Morocco, Italy, Yugoslavia and Turkey are any guide, Teal travelled more widely in the Mediterranean in 1957 than in previous years, and there is also a Garganey reported from Turkey. Recoveries of no fewer than fourteen species of waders are listed, only Snipe and Knot from amongst them not including movements abroad. The remarkable flight of the Sanderling and the return of the Ruff to its Arctic breeding ground provide ample scope for speculation and will spur the wader trappers to yet greater efforts. Then there are the second recovery of an Arctic Skua from Angola; the first of a Kittiwake in the Mediterranean; a Wryneck and a Robin in Sweden; Stonechats in central France and Majorca and three Redpolls in Belgium. Two Woodpigeons ringed as squabs in the same Sussex village were recovered later in France and were only the third and fourth of their species to be recovered abroad. A Starling of probable British stock provides our first-ever recovery in Switzerland; and a Blackbird, ringed as a juvenile in June, was recovered near the Pyrenees in October, this being the first indication from forty-eight years of ringing that individuals of the British population may winter south to Iberia.

One of the outstanding features of 1957 was the immense autumn irruption of tits and certain other species. Fortunately, ringers were able to trap them on a very large scale, and the resulting recoveries are an impressive testimony to the value of ringing in the study of such phenomena (the selection of Great and Blue Tit recoveries published here includes a number advanced from 1958 in order to show them in their proper context).

On the administrative side, an important development was the Committee's decision to undertake the importation of mist-nets from

Japan, and in connection with this, supplementary regulations governing their use were issued to all ringers. At the same time revised arrangements were announced for the recording and reporting of retrap records. The need for an informal publication devoted to the discussion of new equipment and techniques was met by the general distribution of "The Ringers' Bulletin", an initial issue of which had been restricted to subscribers.

The problems of developing better rings again received much attention and experimental models were issued to a number of ringers and observatories for evaluation. Because field trials must be thorough, and because, due to the need for special pliers, it is impracticable to issue new sizes singly, even when proved satisfactory, several years may elapse before the new series can be made available for general issue.

#### FINANCE

As in 1956, the salaries of staff were provided by a grant from the Nature Conservancy. All other expenses were met by the income derived from the sale of rings, supplemented by a grant of £69 8s. 11d. from the main funds of the Trust and a grant of £25 from the publishers of *British Birds*. The full accounts appear in the Annual Report of the British Trust for Ornithology.

The five-year period of the grant from the Nature Conservancy has been extended, by three months, to 31st March 1959: thereafter, provision at a higher rate will be made under a contract which has been placed by the Conservancy with the Trust. The increasing scale of ringing and, still more, the consequently increasing number of recoveries have added greatly to the headquarters work; the augmented financial support will happily permit the engagement of another member of staff in the near future.

#### THE COMMITTEE

The members of the Bird-Ringing Committee on 31st December 1957 were:—Sir Landsborough Thomson (*Chairman*), Miss E. P. Leach, J. S. Ash, A. W. Boyd, Hugh Boyd, E. J. M. Buxton, P. A. D. Hollom, J. D. Macdonald (representing the Trustees of the British Museum) G. R. Mountfort, E. R. Parrinder, Major-General C. B. Wainwright, George Waterston; Bruce Campbell and C. A. Norris (*ex officio*); Robert Spencer (*Secretary*).

#### STAFF

Robert Spencer, J. L. F. Parslow and Miss M. Coleman. Miss E. P. Leach, in an honorary capacity, had charge of all reports of rings from foreign schemes.

#### ACKNOWLEDGEMENTS

Grateful acknowledgement is made to the Trustees for accommodation at the British Museum (Natural History) and for permission to use the address of the museum on rings; to the Nature Conservancy for the generous financial support which enables the

scheme to operate at its present level; to Messrs. H. F. & G. Witherby Ltd. for their annual grant; to Miss E. P. Leach for unstinted help in the office on many occasions; to Dr. W. Rydzewski for advice on technical matters and translations of Polish letters; and to Mrs. G. Trust, Miss Helga Wiese, D. Goodwin and A. G. Hurrell for acting as translators.

## PUBLICATIONS

The following analysis of results has been published:

E. J. M. Buxton (1957): "Migration of the Oystercatcher in the area of Britain: results of ringing". *Brit. Birds*, L: 519-524.

The following papers make use of the recoveries of the scheme:

Hugh Boyd (1957): "Mortality and kill amongst British-ringed Teal *Anas crecca*". *Ibis*, 99: 157-177.

Hugh Boyd (1957): "Mortality and fertility of the White-fronted Goose". *Bird Study*, 4: 80-93.

J. C. Coulson and E. White (1957): "Mortality rates of the Shag estimated by two independent methods". *Bird Study*, 4: 166-171.

J. M. Cullen (1957): "Plumage, age and mortality in the Arctic Tern". *Bird Study*, 4: 197-207.

In addition, the following report is relevant:

E. P. Leach (1958): "British recoveries of birds ringed abroad". *Brit. Birds*, li: 57-72.

For particulars of the ringing of ducks and geese, see also:

Peter Scott and Hugh Boyd (1958): *Ninth Annual Report of the Wildfowl Trust, 1956-1957*.

Table I

NUMBERS OF BIRDS RINGED AND RECOVERED

				<i>Ringed</i>			<i>Recovered</i>
				<i>Juv.-Ad.</i>	<i>Pullus*</i>	<i>Total</i>	<i>Total</i>
1957	...	...	...	137,060	49,286	186,346	5,497
1956	...	...	...	104,665	40,069	144,734	4,808
1955	...	...	...	90,585	35,718	126,303	4,063
1954	(I.I0.53-3I.I2.54)†			77,809	36,684	114,493	3,043
1953	...	...	...	63,318	35,199	98,517	Not recorded
1952	...	...	...	56,867	39,459	96,326	
1951	...	...	...	49,364	36,379	85,743	
1950	...	...	...	42,112	33,994	76,106	
1949	...	...	...	27,496	29,965	57,461	
1948	...	...	...	18,413	20,911	39,324	
Grand Total Ringed 1909-1957 (including arrears)							1,813,632
Grand Total Recovered 1909-1957							47,465

\* An explanation of the term "pullus" or "pull." appears on page 459.

† The ringing year formerly began on 1st October. In 1954 it was decided to make it coincide with the calendar year and there was accordingly a "year" of 15 months.

Table II

RINGING AND RECOVERY TOTALS TO 31.12.57

	Ringed			Recovered		
	<i>Juv.-Ad.</i>	<i>Pull.</i>	1957 <i>Total</i>	<i>Grand</i> <i>Total</i>	1957 <i>Grand</i> <i>Total</i>	
Little Grebe .. .. .	1	—	1	112	—	6
Leach's Petrel .. .. .	1	—	1	241	1	1
Storm Petrel .. .. .	391	24	415	3,128	3	11
Manx Shearwater .. .. .	3,678	1,083	4,761	70,340	138	822
Fulmar .. .. .	37	288	325	3,567	8	39
Gannet .. .. .	57	1,627	1,684	18,755	43	720
Cormorant .. .. .	—	242	242	4,315	62	1,001
Shag .. .. .	141	832	973	6,046	90	625
Heron .. .. .	1	265	266	3,855	33	565
Mallard .. .. .	3,683	273	3,956	21,332	349	2,271
Teal .. .. .	1,344	4	1,348	22,966	387	3,692
Gadwall .. .. .	19	11	30	118	7	19
Wigeon .. .. .	129	—	129	1,916	31	320
Pintail .. .. .	34	—	34	476	5	83
Shoveler .. .. .	37	9	46	399	5	79
Tufted Duck .. .. .	78	2	80	746	9	150
Pochard .. .. .	30	—	30	158	3	25
Eider .. .. .	29	3	32	1,028	1	54
Shelduck .. .. .	1	44	45	664	1	34
Grey Lag Goose .. .. .	1	22	23	463	5	113
White-fronted Goose .. .. .	152	—	152	406	5	77
Pink-footed Goose .. .. .	3,166	—	3,166	8,919	189	1,317
Canada Goose .. .. .	430	5	435	1,010	22	54
Mute Swan .. .. .	200	13	213	281	9	17
Buzzard .. .. .	5	55	60	904	1	43
Sparrowhawk .. .. .	13	10	23	1,277	5	191
Hen Harrier .. .. .	—	36	36	307	4	43
Montagu's Harrier .. .. .	—	5	5	206	—	28
Peregrine .. .. .	—	7	7	162	—	22
Merlin .. .. .	10	20	30	562	3	82
Kestrel .. .. .	27	145	172	2,155	21	248
Red Grouse .. .. .	1,214	1	1,215	1,528	88	97
Water Rail .. .. .	43	—	43	245	1	8
Corncrake .. .. .	5	3	8	697	—	11
Moorhen .. .. .	332	25	357	4,332	20	122
Coot .. .. .	113	8	121	1,362	17	129
Oystercatcher .. .. .	77	593	670	5,529	25	258
Lapwing .. .. .	105	2,537	2,642	65,102	67	1,320
Ringed Plover .. .. .	112	169	281	3,660	3	48
Little Ringed Plover .. .. .	2	27	29	157	1	5
Golden Plover .. .. .	1	32	33	523	—	16
Turnstone .. .. .	32	—	32	266	1	5
Snipe .. .. .	230	117	347	3,130	12	142
Jack Snipe .. .. .	42	—	42	112	2	5
Woodcock .. .. .	15	10	25	5,631	1	429
Curlew .. .. .	18	284	302	6,081	8	240
Common Sandpiper .. .. .	199	43	242	3,112	2	18
Redshank .. .. .	84	147	231	4,661	5	132

NOTE—The "recovery" columns in this table and in Table I omit only retraps—birds caught again locally by the ringer and released. Recaptures by other than the ringer at any distance and local recoveries of dead birds are all included.

	<i>Ringed</i>				<i>Recovered</i>	
	<i>Juv.-Ad.</i>	<i>Pull.</i>	<i>1957 Total</i>	<i>Grand Total</i>	<i>1957</i>	<i>Grand Total</i>
Dunlin .. ..	565	6	571	1,372	13	20
Stone Curlew .. ..	1	2	3	350	1	18
Arctic Skua .. ..	21	70	91	654	4	22
Great Skua .. ..	2	155	157	1,350	—	35
Great Black-backed Gull .. ..	8	325	333	1,957	19	99
Lesser Black-backed Gull .. ..	17	1,011	1,028	20,093	62	817
Herring Gull .. ..	84	1,907	1,991	23,090	94	846
Common Gull .. ..	6	79	85	4,271	4	171
Black-headed Gull .. ..	90	3,756	3,846	40,540	282	1,907
Kittiwake .. ..	446	875	1,321	10,338	38	179
Common Tern .. ..	44	1,397	1,441	27,320	20	539
Arctic Tern .. ..	364	1,824	2,188	12,610	76	167
Roscate Tern .. ..	12	475	487	2,990	2	23
Little Tern .. ..	5	146	151	1,756	6	21
Sandwich Tern .. ..	5	1,682	1,687	29,763	49	488
Razorbill .. ..	83	314	397	9,501	26	255
Guillemot .. ..	91	236	327	6,164	16	213
Black Guillemot .. ..	4	43	47	409	1	5
Puffin .. ..	435	264	699	11,051	4	55
Stock Dove .. ..	18	78	96	1,857	9	118
Rock Dove .. ..	1	4	5	104	1	4
Woodpigeon .. ..	43	251	294	6,448	34	413
Turtle Dove .. ..	38	29	67	1,375	6	46
Cuckoo .. ..	49	28	77	1,688	3	41
Barn Owl .. ..	10	60	70	1,174	10	148
Little Owl .. ..	20	55	75	1,433	5	115
Tawny Owl .. ..	20	182	202	2,394	19	160
Long-eared Owl .. ..	6	19	25	468	2	26
Short-eared Owl .. ..	2	33	35	343	1	22
Nightjar .. ..	4	16	20	378	—	8
Swift .. ..	1,904	95	1,999	6,233	34	97
Kingfisher .. ..	44	13	57	910	1	36
Green Woodpecker .. ..	21	2	23	360	2	11
Great Spotted Wood- pecker .. ..	98	14	112	615	4	25
Wryneck .. ..	15	—	15	500	1	10
Woodlark .. ..	—	26	26	329	—	2
Skylark .. ..	281	229	510	7,697	8	49
Swallow .. ..	1,403	3,097	4,500	76,500	42	524
House Martin .. ..	1,383	40	1,423	18,031	8	135
Sand Martin .. ..	2,422	41	2,463	13,739	7	35
Raven .. ..	—	35	35	706	7	69
Carrion/Hooded Crow	13	92	105	3,360	9	188
Rook .. ..	150	486	636	8,632	49	488
Jackdaw .. ..	270	365	635	8,763	50	448
Magpie .. ..	28	106	134	2,735	7	110
Jay .. ..	91	44	135	1,548	12	105
Chough .. ..	—	20	20	210	1	8
Great Tit .. ..	4,704	1,751	6,455	38,882	73	606
Blue Tit .. ..	15,282	2,003	17,285	80,155	275	1,396
Coal Tit .. ..	892	316	1,208	5,107	12	67
Marsh Tit .. ..	186	23	209	1,476	2	17
Willow Tit .. ..	33	—	33	172	—	—
Long-tailed Tit .. ..	300	—	300	776	1	3
Nuthatch .. ..	142	92	234	1,786	3	40

	Ringed				Recovered	
	<i>Juv.-Ad.</i>	<i>Pull.</i>	1957 <i>Total</i>	<i>Grand Total</i>	1957	<i>Grand Total</i>
Treecreeper .. ..	111	65	176	1,279	2	3
Wren .. ..	1,292	56	1,348	9,081	12	43
Dipper .. ..	25	230	255	3,613	2	45
Mistle Thrush .. ..	237	190	427	8,720	23	221
Fieldfare .. ..	43	—	43	779	—	18
Song Thrush .. ..	2,694	2,147	4,841	102,725	190	2,396
Redwing .. ..	455	—	455	3,624	4	38
Ring Ouzel .. ..	33	52	85	1,342	3	19
Blackbird .. ..	8,157	3,203	11,360	136,326	477	4,414
Wheatear .. ..	1,029	209	1,238	11,300	5	44
Stonechat .. ..	139	46	185	1,959	2	13
Whinchat .. ..	273	179	452	4,546	2	14
Redstart .. ..	877	313	1,190	9,240	6	22
Black Redstart .. ..	24	7	31	449	1	11
Nightingale .. ..	52	37	89	3,287	—	13
Robin .. ..	3,832	964	4,796	59,158	126	1,365
Grasshopper Warbler .. ..	59	5	64	447	—	1
Reed Warbler .. ..	201	136	337	2,876	2	11
Sedge Warbler .. ..	1,346	80	1,426	7,869	4	14
Blackcap .. ..	300	18	318	2,684	2	10
Barred Warbler .. ..	18	—	18	100	—	—
Garden Warbler .. ..	314	21	335	3,410	—	4
Whitethroat .. ..	4,936	517	5,453	30,090	25	110
Lesser Whitethroat .. ..	175	—	175	1,872	3	6
Willow Warbler .. ..	4,856	588	5,444	41,139	7	95
Chiffchaff .. ..	1,253	55	1,308	6,980	2	14
Wood Warbler .. ..	12	50	62	2,018	—	11
Goldcrest .. ..	643	—	643	2,411	—	5
Spotted Flycatcher .. ..	169	178	347	9,012	5	60
Pied Flycatcher .. ..	182	349	531	10,400	1	23
Dunnock .. ..	4,113	597	4,710	38,009	65	513
Meadow Pipit .. ..	1,804	260	2,064	17,130	12	132
Tree Pipit .. ..	56	74	130	3,237	1	4
Rock/Water Pipit .. ..	754	170	924	5,510	3	38
Pied/White Wagtail .. ..	1,060	430	1,490	14,918	29	235
Grey Wagtail .. ..	34	76	110	2,026	1	10
Yellow Wagtail ssp. .. ..	1,038	147	1,185	6,353	10	45
Red-backed Shrike .. ..	43	143	186	1,835	1	8
Starling .. ..	18,188	978	19,166	207,416	967	7,541
Hawfinch .. ..	6	9	15	175	—	2
Greenfinch .. ..	5,102	500	5,602	63,349	120	882
Goldfinch .. ..	266	65	331	1,994	3	17
Siskin .. ..	9	—	9	129	—	2
Linnet .. ..	1,688	926	2,614	24,700	17	163
Twite .. ..	234	14	248	1,704	—	6
Redpoll .. ..	121	16	137	1,009	3	12
Bullfinch .. ..	489	172	661	3,682	12	57
Crossbill .. ..	1	1	2	154	—	2
Chaffinch .. ..	3,562	513	4,075	64,793	48	726
Brambling .. ..	139	—	139	2,952	1	23
Yellowhammer .. ..	375	190	565	11,533	3	92
Corn Bunting .. ..	62	21	83	514	3	11
Cirl Bunting .. ..	2	6	8	140	—	—
Reed Bunting .. ..	831	206	1,037	7,817	1	30
Snow Bunting .. ..	337	—	337	1,189	—	3
House Sparrow .. ..	13,786	385	14,071	56,535	170	742
Tree Sparrow .. ..	706	265	971	5,862	1	36

## SPECIES OF WHICH LESS THAN 100 HAVE BEEN RINGED

(1957 total, grand total, 1957 recoveries and grand total recoveries are given in that order).

Black-throated Diver	1	2	—	—	Red-necked Phalarope	..	..	21	—	—
Great Northern Diver	—	2	—	—	Glaucous Gull	..	..	2	—	1
Red-throated Diver	—	6	—	3	Little Gull	..	..	1	—	1
Great Crested Grebe	1	23	—	—	Black Tern	..	..	1	—	—
Red-necked Grebe	—	1	—	—	Gull-billed Tern	..	..	1	—	1
Slavonian Grebe	..	—	1	—	Little Auk	..	..	1	14	—
Wilson's Petrel	..	—	1	—	Collared Dove	..	..	2	—	—
Little Bittern	..	—	1	—	Scops Owl	..	..	1	—	—
Bittern	..	5	50	—	Snowy Owl	..	..	—	1	—
Garganey	..	15	97	1	10	Hoopoe	..	..	1	4
Red-crested Pochard	2	10	—	3	Lesser Spotted Woodpecker	..	..	2	57	—
Scaup	..	2	22	—	2	Short-toed Lark	..	..	—	1
Goldeneye	..	—	5	—	—	Shore Lark	..	..	—	1
Long-tailed Duck	..	—	2	—	—	Golden Oriole	..	..	—	1
Velvet Scoter	..	—	1	—	1	Crested Tit	..	..	—	35
Common Scoter	..	1	10	—	1	Bearded Tit	..	..	1	48
Red-breasted Merganser	..	1	11	—	1	Black-throated Thrush	..	..	1	1
Goosander	..	1	54	—	10	American Robin	..	..	—	1
Smew	..	1	2	—	—	Siberian Thrush	..	..	—	1
Brent Goose	..	—	2	—	1	Gray-checked Thrush	..	..	—	1
Barnacle Goose	..	—	3	—	1	Desert Wheatear	..	..	—	2
Whooper Swan	..	—	3	—	2	Black-eared Wheatear	..	..	—	1
Golden Eagle	..	5	25	1	1	Pied Wheatear	..	..	—	1
Marsh Harrier	..	3	99	2	9	Thrush Nightingale	..	..	1	1
Hobby	..	2	50	—	4	Bluethroat	..	..	14	98
Red-footed Falcon	—	1	—	—	—	Lanceolated Warbler	..	..	1	1
Black Grouse	..	7	10	—	—	Pallas's Grasshopper Warbler	..	..	—	1
Capercaillie	..	—	3	—	—	Marsh Warbler	..	..	5	51
Red-legged Partridge	—	20	1	2	—	Paddyfield Warbler	..	..	—	1
Partridge	..	5	87	—	2	Aquatic Warbler	..	..	—	6
Quail	..	—	3	—	—	Thick-billed Warbler	..	..	—	1
Pheasant	..	—	58	—	4	Melodious Warbler	..	..	7	17
Spotted Crane	..	1	5	—	—	Icterine Warbler	..	..	2	38
Kentish Plover	..	—	1	—	—	Olivaceous Warbler	..	..	—	2
Grey Plover	..	5	7	—	1	Orphean Warbler	..	..	—	1
Dotterel	..	1	26	—	—	Subalpine Warbler	..	..	—	5
Whimbrel	..	4	84	—	—	Dartford Warbler	..	..	6	47
Bar-tailed Godwit	..	11	30	—	—	Greenish Warbler	..	..	2	8
Green Sandpiper	..	15	72	1	1	Bonelli's Warbler	..	..	—	1
Wood Sandpiper	..	9	43	—	—	Arctic Warbler	..	..	—	1
Spotted Redshank	3	12	—	1	—	Yellow-browed Warbler	..	..	2	31
Greenshank	..	13	45	1	2	Pallas's Warbler	..	..	1	2
Knot	..	30	81	1	3	Yellowthroat	..	..	—	1
Purple Sandpiper	..	3	22	—	—	Firecrest	..	..	21	48
Little Stint	..	40	70	—	1	Red-breasted Flycatcher	..	..	3	41
Temminck's Stint	..	—	3	—	—	Tawny Pipit	..	..	—	2
White-rumped Sandpiper	..	—	1	—	—	Yellow-headed Wagtail	..	..	—	2
Pectoral Sandpiper	1	3	—	—	—	Waxwing	..	..	20	27
Curlew Sandpiper	..	12	45	—	—	Great Grey Shrike	..	..	—	30
Semi-palmated Sandpiper	..	—	1	—	—	Lesser Grey Shrike	..	..	—	4
Sanderling	..	36	86	1	1					
Buff-breasted Sandpiper	..	—	1	—	—					
Ruff	..	34	84	1	2					
Grey Phalarope	..	1	4	—	—					



Woodchat Shrike ..	3	16	—	—	Red-headed Bunting	2	4	—	—
Rose-coloured Starling ..	—	1	—	—	Yellow-breasted Bunting ..	—	1	—	—
Summer Tanager ..	1	1	—	—	Ortolan Bunting ..	1	14	—	—
Scarlet Grosbeak ..	3	11	—	—	Rustic Bunting ..	1	3	—	—
Pine Grosbeak ..	—	1	—	—	Little Bunting ..	2	6	—	—
Black-headed Bunting	—	1	—	—	Lapland Bunting ..	—	30	—	—

Table III

NUMBERS AND DISTRIBUTION OF RINGERS (as at 31.12.57)

ENGLAND					SCOTLAND				
County	Category of permit			Total	County	Category of permit			Total
	A	B	C			A	B	C	
Bedfordshire ..	3	—	—	3	Aberdeenshire ..	3	1	1	5
Berkshire ..	15	3	2	20	Angus ..	3	—	—	3
Buckinghamshire ..	7	—	1	8	Berwickshire ..	1	—	—	1
Cambridgeshire ..	3	1	3	7	Dumfries-shire ..	3	—	—	3
Cheshire ..	13	—	4	17	Inverness-shire ..	4	—	—	4
Cornwall ..	1	—	—	1	Kirkcudbright ..	2	—	—	2
Cumberland ..	3	—	1	4	Midlothian ..	19	5	1	25
Derbyshire ..	7	—	—	7	Orkney ..	1	—	—	1
Devonshire ..	8	2	—	10	Perthshire ..	1	—	—	1
Dorset ..	8	6	2	16	Ross-shire ..	1	—	—	1
Durham ..	13	8	4	25	Shetland ..	1	—	—	1
Essex ..	34	2	8	44	Stirlingshire ..	1	—	—	1
Gloucestershire ..	6	—	6	12	Sutherland ..	1	—	—	1
Hampshire ..	2	—	—	2	Wigtownshire ..	—	—	1	1
Herefordshire ..	8	—	1	9					
Hertfordshire ..	21	1	2	24					
Kent ..	26	—	6	32					
Lancashire ..	24	—	1	25					
Leicestershire ..	2	—	—	2					
Lincolnshire ..	10	7	1	18					
London ..	11	—	2	13					
Middlesex ..	10	1	2	13					
Norfolk ..	6	2	—	8					
Northamptonshire	7	—	1	8					
Northumberland ..	5	2	1	8					
Nottinghamshire ..	4	—	—	4					
Oxfordshire ..	12	1	2	15					
Shropshire ..	1	—	—	1					
Somerset ..	11	—	1	12					
Staffordshire ..	7	—	1	8					
Suffolk ..	11	3	—	14					
Surrey ..	39	1	5	45					
Sussex ..	16	—	1	17					
Warwickshire ..	14	1	2	17					
Westmorland ..	1	—	—	1					
Wiltshire ..	2	—	—	2					
Yorkshire ..	50	13	4	67					
Isle of Man ..	4	—	3	7					

WALES				
County	Category of permit			Total
	A	B	C	
Caernarvonshire ..	3	—	—	3
Cardiganshire ..	1	—	1	2
Denbighshire ..	2	—	—	2
Flintshire ..	—	1	—	1
Glamorganshire ..	4	—	—	4
Pembrokeshire ..	—	5	—	5

IRELAND				
County	Category of permit			Total
	A	B	C	
Antrim ..	6	6	—	12
Down ..	1	1	—	2
Dublin ..	3	—	—	3
Mayo ..	1	—	—	1

**Table IV**  
APPROXIMATE TOTALS OF RINGS ISSUED ANNUALLY

	<i>Ring Size</i>								
	1	1A	2	3	DE	4	GH	5	Others *
1957	107,500	58,400	8,300	14,450	9,050	5,650	1,800	1,450	11,050
1956	79,000	59,600	9,000	14,200	8,500	3,300	2,800	1,400	2,400
1955	55,000	45,800	7,000	8,200	9,100	2,100	2,400	1,500	2,250
1954	54,700	38,200	5,700	9,600	8,700	4,700	1,800	1,000	6,050
1953	44,000	35,300	7,100	9,300	4,600	3,400	500	—	3,350

\* This column includes size Clip 4, special rings for the Wildfowl Trust, and all experimental rings.

KEY TO RINGERS' INITIALS

AA	A. Allen	RFL	Miss R. F. Levy
DRA	D. R. Anderson	AEM	A. E. Male
JWA	J. W. Allen	BAEM	B. A. E. Marr
RWA	R. W. Arthur	CDTM	C. D. T. Minton
GHC B	G. H. C. Byford	PPM	P. P. Mackie
HVDB	H. Van den Bos	CAN	C. A. Norris
JAB	J. A. Benington	ABO	A. B. Old
JAGB	J. A. G. Barnes	BBO	Bardsey Bird Observatory
RHB	R. H. Baillie	BrBO	Bradwell Bird Observatory
SSPB	Scottish Society for the Protection of Wild Birds	CBO	Cley Bird Observatory
DBC	Dingle Bird Club	DBO	Dungeness Bird Observatory
DFC	Dublin Field Club	MHBO	Monks' House Bird Observatory
DMC	D. M. Cormack	SABO	St. Agnes Bird Observatory
FRC	F. R. Clifton	ACP	A. C. Parker
MJC	M. J. Cowlard	DP	D. Parr
MOC	Midlothian Orn. Club	EMP	Miss E. M. Palmer
PC	P. J. Conder	IJP	I. J. Patterson
PJC	P. J. Chadwick	RP	R. Perry
RPC	R. P. Cockbain	WDP	W. D. Park
WSC	The late W. S. Cowin	WMP	W. M. Peet
CRD	C. R. Dick	RWR	R. W. Robson
ED	E. Duffey	AVS	A. V. Smith
HD	H. Davies	BRS	B. R. Spence
VCWE	V. C. Wynne-Edwards	CS	Clayesmore School
ACF	A. C. Fraser	DS	Lord David Stuart
GTF	G. T. Flock	ESS	E. S. Skinner
MAFF	Ministry of Agriculture, Fisheries and Food	HSS	Halifax Scientific Society
AG	A. Gibbs	JS	J. Stafford
EAG	Miss E. A. Garden	LNHS	London Natural History Society
FCG	F. C. Gribble	OOS	Oxford Ornithological Society
JCG	J. C. Gittins	RS	R. Stokoe
CH	C. Hodgkinson	RRS	Romford Ringing Station
CJH	C. J. Henty	RTS	R. T. Smith
DDH	D. D. Harber	SBRS	Sandwich Bay Ringing Station
DFH	D. F. Harle	WNS	Wharfedale Naturalists' Society
DJTH	D. J. T. Hussell	ADT	A. D. Townsend
NH	N. Henson	CFT	C. F. Tebbutt
RCH	R. C. Homes	NNT	Norfolk Naturalists' Trust
WH	W. Howe	TT	T. Todd
EGI	Edward Grey Institute	WT	Wildfowl Trust
AHJ	A. H. Johnson	AEV	A. E. Vine
JNK	J. N. Keeling	DCHW	D. C. H. Worsfold
JL	J. Lees		
JWL	J. W. Lund		
RL	R. Lovegrove		

DRW	D. R. Wilson	HE&W	Hurrell, Ebert & Waite
ELEW	E. L. E. Watkiss	J&AP	J & A. H. Platt
JW	J. Wagstaff	L&R	Leicestershire & Rutland Orn. Society
RGW	R. G. Wheeler	ND&N	Northumberland, Durham & Newcastle N.H.S.
A&R	Ash & Ridley	P&B	Pyman & Barton
B&T	Bilby & Taylor	P&P	Parrinder & Parrinder
C&E	Carter & Edwards	Sa&W	Sanderson & Walker
D&Q	Dickens & Quin	Sm&W	Smith & Walker
D&W	Dunkling & Websper	W&M	Watts & McConville
F&M	Flegg & Musson		
H&M	Hamilton & Macgregor		
H&S	Huddart & Sharp		

NOTE—Ringers' initials are omitted when the ringing was carried out: (i) at one of the following observatories—Bardsey, Cley, Copeland, Dungeness, Fair Isle, Gibraltar Point, Lundy, Isle of May, Portland, Great Saltee, Skokholm and Spurn; (ii) at Abberton Reservoir—where all ringing is carried out by Major-General C. B. Wainwright; (iii) by the Wildfowl Trust (nearly all ducks and geese).

## Selected List of Recoveries Reported during 1957

### Key to Symbols and Terms

Ring number : Where this is in italics the ring has been returned.

O : Indicates bird breeding, or bred, at place of ringing.

Age : pull. (pullus)—nestling or chick, *not yet flying* ;

juv.—*young, able to fly freely* ;

1stW.—bird in its first winter ;

f.g.—full-grown, age uncertain ;

ad.—adult ; at least one year old.

Sex : ♂—male ; ♀—female.

v : Caught or trapped, and released with ring.

+ : Shot or killed by Man.

× : Found dead or dying.

() : Caught or trapped alive, and not released, or released but with ring removed.

[?] : Manner of recovery unknown.

Date of recovery : Where this is unknown the date of the reporting letter is given in brackets.

Distance : The distance, given in miles, and the directions are approximate.

Arrangement of entry : Ringing details are given on the first or first and second lines, with recovery data on a new line below.

NOTE—The following list is highly selective. To indicate the quantity and nature of the material omitted the total number of recoveries is stated in brackets after the scientific name of each species, followed by the minimum movement, in miles, to qualify for inclusion. Foreign recoveries are either given in full or mentioned in the summaries. Species which produced only local recoveries are left out, but the individual totals thus omitted are listed in Table II.

### Manx Shearwater (*Procellaria puffinus*) (138: 100 miles)

114006	ad.	2.7.57	Hallival: 56°59'N. 6°17'W., Rhum (Inverness-shire)CH
×		1.8.57	Machrie, Isle of Islay (Argyllshire) 85m. S.
336138	ad.	15.7.56	Copeland: 54°40'N. 5°32'W. (Down)
v		22.7.57	Bardsey (Caernarvonshire) 135m. SSE.
334646	ad.	10.8.55	Skomer: 51°44'N. 5°19'W. (Pembrokeshire) H&S
×		14.4.57	Nr. Portballintrae (Antrim) 230m. NNW.
338518	ad.	8.4.56	Skokholm: 51°42'N. 5°16'W. (Pembrokeshire)
×		22.7.57	Formby (Lancashire) 160m. NE.
338761	ad.	15.4.56	Skokholm
×		7.8.57	Maryport (Cumberland) 220m. NNE.

AT25339	ad.	20.3.55	Skokholm
×	ca.	26.8.57	Nr. Llanfaethlu (Anglesey) 115m. NNE.
AT28960	ad.	15.6.55	Skokholm
/?	(12.2.57)		San Francisco do Sul: 26°13'S. 48°36'W. (Santa Catharina Brazil)
AT48865	ad.	19.7.57	Skokholm
()		22.9.57	Off Cabo Frio: 23°01'S. 42°02'W. (Rio de Janeiro) Brazil

Including the two published here, there have now been fourteen recoveries of Manx Shearwaters from Brazil. There were 24 other recoveries abroad, 7 off north Spain, January-March, and 17 in French waters, April-September. 82 birds were recovered dead on Skokholm, apparently the victims of Great Black-backed Gulls.

### Fulmar (*Fulmarus glacialis*) (8: 5 miles).

372782	O	pull.	10.7.56	St. Kilda: 57°49'N. 8°34'W., Outer Hebrides	DRW
/?			18.9.57	At sea off south Norway: ca. 57°35'N. 6°50'E.	
AT45068	O	pull.	10.7.56	St. Kilda	Sm&W
()			30.6.57	Flemish Cap: 46°20'N. 45°25'W. off Newfoundland	
AT45073	O	pull.	10.7.56	St. Kilda	Sm&W
/?			28.8.57	At sea off west Ireland: ca. 54°00'N. 11°00'W.	
AT45122	O	pull.	10.7.56	St. Kilda	Sm&W
+			(16.7.57)	Oderin Bank: 47°17'N. 54°42'W. Placentia Bay, Newfoundland	Newfoundland
AT34313	O	pull.	17.8.55	Eynhallow: 59°08'N. 3°08'W. (Orkney)	VCWE
/?			29.8.57	At sea off west Ireland: 53°35'N. 10°50'W.	
371622	O	pull.	19.8.55	Gairsay: 59°05'N. 2°57'W. (Orkney)	VCWE
()			15.3.57	St. Pierre Bank: 45°54'N. 55°17'W. Newfoundland	Newfoundland
AT33892	O	pull.	2.8.55	St. John's Point: 58°39'N. 3°12'W. (Caithness)	DMC
+			15.8.57	Off Sardlock Outpost: ca. 60°40'N. 46°10'W. Julianehåb District, Greenland	Greenland

### Gannet (*Sula bassana*) (43)

Birds were recovered in British waters at distances of up to 250 miles from the ringing localities, most of the movements being the southerly dispersal of juveniles. Foreign recoveries were as follows:—

TABLE A—COUNTRY AND MONTH OF RECOVERY OF GANNETS (*Sula bassana*)

Country of Recovery	Aug.	Sept.	Oct.	Nov.	Dec.	Jan.	Feb.	Mar.	Apr.	May	Total
Norway	...		1	1							2
Denmark	...		2		1						3
Holland	...	1	1	1	1						4
Belgium	...		1								1
France ...	...		2		3		3	1			9
Spain ...	...		1	1							2
Portugal	...		1	1						1	3
Africa ...	...				2			1			3

NOTE—The above and other similar tables in this Report are subject to error in cases where the date of recovery has been assumed to be approximately that of the letter reporting the recovery, whereas the bird may have been dead for some time before being found or reported.

**Cormorant** (*Phalacrocorax carbo*) (62)

11 Birds from Wigtownshire (1), Anglesey (2), Pembroke (1) and Devon (6) were recovered in French waters (8) and off the north coast of Spain (2) in the months August to February. Eight of the birds were in their first winter, two in their second.

11 Recoveries in home waters show movements of up to 260 miles. Overland passage is indicated in the following:—

7938	O pull.	21.6.57	Castle Loch: 54°47'N. 4°34'W. Mochrum (Wigtownshire) DS
	+	2.10.57	Nr. Berwick-on-Tweed (Northumberland) 120m. ENE
7754	O pull.	27.6.57	Castle Loch DS
	×	27.10.57	Broughty Ferry, nr. Dundee (Angus) 128m. NE.
7691	O ad.	24.5.48	Castle Loch DS
	transp.	24.5.48	Cambridge
	×	4.5.57	Monreith (Wigtownshire)

11 Monreith is 9 miles from where the bird was originally caught.

4294	O pull.	13.6.57	Farne Islands: 55°37'N. 1°37'W. (Northumberland) ND&N
	()	23.12.57	Walthamstow (Essex) 285m. SSE.

**Shag** (*Phalacrocorax aristotelis*) (90: 125 miles)

11 Thirteen Shags ringed in Devon and Cornwall were recovered in French waters, twelve between August and February; one in May. One bird was in its second winter; the remainder were first-winter birds.

7724	O pull.	9.8.57	Foula: 60°08'N. 2°07'W. (Shetland) DRW
	()	6.11.57	Badachro, Gairloch (Ross-shire) 215m. SW.
6127	O pull.	10.8.57	Foula D&Q
	×	23.10.57	Nr. Golspie (Sutherland) 160m. SSW.
6131	O pull.	10.8.57	Foula D&Q
	×	11.10.57	Nr. Golspie 160m. SSW.
6158	O pull.	12.8.57	Foula D&Q
	v	13.10.57	Peterhead (Aberdeenshire) 180m. S.
6102	O pull.	29.6.57	Farne Islands: 55°37'N. 1°37'W. (Northumberland) ND&N
	+	(14.10.57)	Nr. Nottingham 180m. S.
6113	O pull.	13.6.57	Ynys Gwylan-fawr: 52°48'N. 4°42'W., Aberdaron Bay (Caernarvonshire) BBO
	v	31.8.57	Marsden (Co. Durham) 200m. NE.
	×	3.9.57	Marsden
6169	O pull.	1.7.57	Lundy: 51°12'N. 4°40'W. (Devon)
	+	20.8.57	Littleport (Cambridgeshire) 225m. ENE.
6166	O pull.	1.7.57	Lundy
	×	24.8.57	Nr. St. Ives (Huntingdonshire) 210m. ENE.
61757	O pull.	26.6.57	Lundy
	()	28.8.57	Felixstowe (Suffolk) 250m. ENE.
61754	O pull.	26.6.57	Lundy
	×	10.9.57	Moreton, nr. Ongar (Essex) 210m. ENE.

**Heron** (*Ardea cinerea*) (33: 100 miles)

6383	O pull.	30.4.55	Walthamstow: 51°36'N. 0°02'W. (Essex) AG
	×	24.2.57	Nr. Strathaven (Lanarkshire) 325m. NW.
6398	O pull.	19.4.53	High Halstow: 51°22'N. 0°41'E. (Kent) EGI
	×	17.5.57	Warwick 105m. NW.

**Mallard** (*Anas platyrhynchos*) (349)

930777	f.g. ♂	13.2.56	Nr. Ludham: 52°42'N. 1°33'E. (Norfolk)
	+	20.10.57	Losna: 61°23'N. 10°15'E. (Opland) <b>Norway</b>
938609	ad. ♀	8.6.57	Abberton: 51°50'N. 0°53'E. (Essex)
	+	(9.9.57)	Nr. Rotterdam; 51°55'N. 4°29'E. (Z- <b>Holland</b> )
938644	juv. ♂	17.6.57	Abberton
	+	13.9.57	Uitgeest: 52°32'N. 4°42'E. (N- <b>Holland</b> )
940006	juv. ♂	29.7.57	Abberton
	+	20.12.57	Peyrat-le-Chateau: 45°49'N. 1°44'E. (Haute-Vienne) <b>France</b>
940268 & Bruxelles	f.g. ♀	16.7.57	Meetkerke: 51°14'N. 3°09'E. (W. Flanders) <b>Belgium</b>
2H093	v	3.11.57	Abberton
	+	6.11.57	Warhem: 50°58'N. 2°30'E. nr. Bergues (Nord) <b>France</b>
939066	f.g. ♂	18.8.54	Slimbridge: 51°44'N. 2°25'W. (Gloucestershire)
	+	31.12.57	Nr. Magaz de Cepeda: 42°33'N. 6°05'W. (León) <b>Spain</b>
942744	ad. ♀	21.4.57	Slimbridge
	+	ca.1.12.57	Vught: 51°41'N. 5°15'E. (N-Brabant) <b>Holland</b>
Orielton	O pull.	14.6.50	Orielton: 51°40'N. 4°57'W. (Pembrokeshire)
4810	+	0.11.57	Nr. Durgerdam: 52°23'N. 5°00'E. (N- <b>Holland</b> )

In addition to the above, 72 birds ringed in the British Isles between August and March were recovered abroad as follows:—

TABLE B—COUNTRY AND MONTH OF RECOVERY OF MALLARD (*Anas platyrhynchos*)

Country of Recovery	Apr.	May	June	July	Aug.	Sept.	Oct.	Nov.	Dec.	Jan.	Total
France	...			1	3			2	1	2	9
Holland and Belgium	...				7	6	2	1		2	19*
Denmark	...				5	2	5	3			15
Germany and Poland	...		1	1	3	1		1			7
Sweden and Finland	...			1	5	4	2				13*
U.S.S.R.†	...	1	1		3	3					9*

\*Recoveries where exact month of recovery is not known are omitted from the monthly columns but included under "Total".

†Including the Baltic States.

See footnote to Table A.

Of 269 Mallard recovered in the British Isles only 45 show movement of more than 50 miles, and none ringed in Great Britain was recovered in Ireland.

**Teal** (*Anas crecca*) (387)

912858	f.g. ♂	31.8.53	Nr. Peterborough: 52°38'N. 0°17'W. (Northamptonshire)
	+	20.1.57	Nr. Beysehkir: 37°38'N. 31°44'E. (Konya) <b>Turkey</b>
918696	f.g. ♀	4.2.55	Nr. Peterborough
	+	5.2.57	Nr. Ravenna: 44°25'N. 12°15'E. <b>Italy</b>
915910	1st W. ♂	31.12.53	Abberton: 51°50'N. 0°53'E. (Essex)
	+	3.2.57	Cakmak: 39°11'N. 31°49'E. nr. Sivrihisar, <b>Turkey</b>
918019	1st W. ♂	18.10.55	Abberton
	+	15.2.57	Hutovo Blato: ca. 43°06'N. 17°47'E. (Herzegovina) <b>Jugoslavia</b>

06270	1st.W. ♂	11.11.55	Abberton
+		13.3.57	Nr. Cremona: 45° 08'N. 9°54'E. (Lombardy) <b>Italy</b>
08899	1st.W. ♀	22.9.56	Abberton
+		19.3.57	Cassano d'Adda: 45°32'N. 9°31'E. (Milan) <b>Italy</b>
09432	1st.W. ♀	1.11.56	Abberton
+		20.1.57	Sidi Yahia: 33°50'N. 6°53'W., <b>Morocco</b>
0986	juv. ♂	27.9.50	Breukelen-St.-Pieters: 52°11'N. 5°07'E. (Utrecht)
den			<b>Holland</b>
0623	v	6.2.56	Nr. Weymouth: 50°40'N. 2°36'W. (Dorset)
+		18.2.57	Nr. Villa del Foro: 44°54'N. 8°39'E. (Alessandria)
			<b>Italy</b>

In addition to the above 179 birds ringed in the British Isles between August (one only) and March were recovered abroad as follows:—

TABLE C—COUNTRY AND MONTH OF RECOVERY OF TEAL (*Anas crecca*)

Country of recovery	May	June	July	Aug.	Sept.	Oct.	Nov.	Dec.	Jan.	Feb.	Mar.	Total
Den ...							1	2				3
France ...				1			2	6	8	5		22
Germany & Belgium	2		1	3	2	1	1	2	4	2	1	20*
Denmark				15	13	7	1	1				37
Denmark & Holland				4	9	3	1					17
Norway & Sweden	6	1	1	9	4	1						21†
Ireland	7	3	1	9	8							29*
U.S.S.R. & Baltic States	5		1	13	6	3	1					30*

\* Recoveries where exact month of recovery is not known are omitted from monthly columns but included under "Total".

† Same bird recovered in two different months.

‡ See footnote to Table A.

22 Teal ringed in England and Wales were recovered in Ireland. Of the remaining 158 recoveries in the British Isles, 4 show a movement of over 300 miles, 17 a movement of 200-299 miles, 34 a movement of 100-199 miles, and 63 a movement of less than 100 miles.

**Garganey (*Anas querquedula*) (1)**

0523	juv. ♂	7.8.53	Abberton: 51°50'N. 0°53'E. (Essex)
+		2.5.57	Istanbul: 41°03'N. 28°55'E., <b>Turkey</b>

**Gadwall (*Anas strepera*) (7)**

01192	O pull.	22.6.57	Abberton: 51°50'N. 0°53'E. (Essex)
	v	12.7.57	ibid
+		15.8.57	Tinglev: 54°57'N. 9°15'E. (Jutland) <b>Denmark</b>
egg-clip	O pull.	1.7.57	Abberton
+		21.9.57	Nr. Kampen: 52°53'N. 5°55'E. (Overijssel) <b>Holland</b>
egg-clip	O pull.	1.7.57	Abberton
+		15.8.57	Tinglev, <b>Denmark</b>
01184	ad. ♂	7.5.57	Abberton
+		23.9.57	Zwarte Meer: ca. 52°38'N. 5°56'E. (Overijssel) <b>Holland</b>

3024193	O	pull.	12.7.57	Abberton
	+		5.11.57	Baie d'Authie: 50°22'N. 1°32'E. (Pas de Calais) <b>France</b>
3024195	O	pull.	14.7.57	Abberton
	()		11.11.57	St.-Laurent-de-la-Salanque: 42°46'N. 2°59'E. (Pyrénées Orientales) <b>France</b>
939191		f.g. ♂	27.9.54	Slimbridge: 51°44'N. 2°25'W. (Gloucestershire)
	+		6.10.57	Nr. Radolfzell: 47°44'N. 8°59'E. (Baden-Württemberg) <b>Germany</b>

The first three birds listed were from the same brood.

### Wigeon (*Anas penelope*) (31)

TABLE D—COUNTRY AND MONTH OF RECOVERY OF WIGEON (*Anas penelope*)

Country of recovery	May	June	July	Aug.	Sept.	Oct.	Nov.	Dec.	Jan.	Feb.	Mar.	Total
France ...								1	1	1		3
Ireland ...								2				2
England & Wales									3	2		5
Holland						2	1	1			1	5
Germany						1						1
Denmark					1	1	1					3
Sweden ...					1							1
U.S.S.R.	4				3	3						11*

\*Includes one reported as "summer".  
See footnote to Table A.

27 of the birds had been ringed at Abberton, 4 near Peterborough.

### Pintail (*Anas acuta*) (5: 20 miles)

918835		f.g. ♀	11.3.56	Nr. Peterborough: 52°40'N. 0°17'W. (Northamptonshire)
	×		6.7.57	Lambafjöll: 65°26'N. 16°08'W. Jökulsá á Fjöllum River, <b>Iceland</b>
932897		ad. ♂	31.12.55	Abberton: 51°50'N. 0°53'E. (Essex)
	+		27.9.57	Wyk: 54°42'N. 8°34'E. Föhr Island (Schleswig-Holstein) <b>Germany</b>
932898		ad. ♀	31.12.55	Abberton
	+		16.12.57	Wyk, Föhr Island, <b>Germany</b>

918835 is our first recovery of this species in Iceland.

### Shoveler (*Spatula clypeata*) (5)

AH2266	O	pull.	26.6.55	Gladhouse Reservoir: 55°46'N. 3°08'W. (Midlothian) Sm&W
	+		2.1.57	Medway Estuary (Kent) 340m. SE.
932845		ad. ♀	8.7.54	Abberton: 51°50'N. 0°43'E. (Essex)
	+		23.10.57	Zwarte Meer: ca. 52°38'N. 5°56'E. (Overijssel) <b>Holland</b>
919185		1st W. ♂	7.1.56	Slimbridge: 51°44'N. 2°25'W. (Gloucestershire)
	+		29.3.57	Nr. Milan: 45°28'N. 9°12'E. <b>Italy</b>
938982		f.g. ♀	4.4.56	Slimbridge
	+		14.1.57	Earith (Huntingdonshire) 108m. ENE.
3007229		1st W. ♂	15.1.57	Slimbridge
	+		11.5.57	Nr. Cherepovets: 59°09'N. 37°50'E. (Vologda) <b>U.S.S.R.</b>



**Tufted Duck (*Aythya fuligula*) (9: 40 miles)**

99008	f.g. ♀	20.1.57	Nr. Peterborough: 52°40'N. 0°17'W. (Northamptonshire)
+		26.5.57	Nr. Aksarka: 66°33'N. 67°47'E. (Tumen) <b>U.S.S.R.</b>
8481	ad. ♀	3.4.50	Abberton: 51°50'N. 0°53'E. (Essex)
+		10.9.57	Nr. Karpogorsk: 64°00'N. 44°33'E. (Arkhangel) <b>U.S.S.R.</b>
2940	ad. ♂	28.2.56	Abberton
+		end 1.57	Nr. Gouda: 52°03'N. 4°43'E. (Z-Holland)
2976	1stW. ♂	3.1.57	Abberton
[/]		20.8.57	Nr. Leningrad: <b>U.S.S.R.</b>
2985	ad. ♂	14.6.57	Abberton
×		8.11.57	Heeger Meer: 52°57'N. 5°35'E. (Friesland) <b>Holland</b>
Orielton	f.g.	10.2.56	Orielton: 51°40'N. 4°57'W. (Pembrokeshire)
330	×	0.9.56	Slotermeer: 52°55'N. 5°38'E. (Friesland) <b>Holland</b>
Orielton	ad. ♂	14.2.57	Orielton
651	+	22.5.57	Nr. Petchora: 65°08'N. 57°12'E. (Komi) <b>U.S.S.R.</b>

Note date of ringing of 932985.

**Pochard (*Aythya ferina*) (3)**

8952	f.g. ♀	28.12.56	Nr. Peterborough: 52°40'N. 0°17'W. (Northamptonshire)
×		23.8.57	Nr. Warns: 52°53'N. 5°24'E. (Friesland) <b>Holland</b>
9556	f.g. ♀	19.9.54	Nr. Peterborough: 52°38'N. 0°17'W.
+		(19.1.57)	Lanesborough (Roscommon) 330m. WNW.
2949	ad. ♂	8.3.56	Abberton: 51°50'N. 0°53'E. (Essex)
+		0.10.57	Albufera Lake: 39°20'N. 0°22'W. (Valencia) <b>Spain</b>

This is the first recovery of a Pochard from Iberia.

**White-fronted Goose (*Anser albifrons*) (5: 5 miles)**

0066	ad.	25.2.51	Slimbridge: 51°44'N. 2°25'W. (Gloucestershire)
+		spring 1957	Kolguev Island: ca. 69°00'N. 49°00'E. <b>U.S.S.R.</b>
7366	1stW. ♀	29.2.52	Slimbridge
+		0.5.57	Nr. Naryan-Mar: 67°38'N. 53°02'E. (Arkhangel) <b>U.S.S.R.</b>
WT16	1stW.	29.2.52	Slimbridge
+		spring 1957	Kolguev Island, <b>U.S.S.R.</b>
3390	ad. ♀	15.2.53	Slimbridge
+		17.3.57	Nr. Neuhaus: 53°50'N. 9°08'E. (Niedersachsen) <b>Germany</b>

**Pink-footed Goose (*Anser arvensis brachyrhynchus*) (189)**

The recoveries were all from the main wintering areas in the British Isles, birds being reported from the breeding grounds. Work on this species is heavily handicapped by the steadily falling percentage of rings returned.

**Canada Goose (*Branta canadensis*) (22)**

Most of the records refer to birds which were resettled on new waters and subsequently recovered at or near their new locality.

578	O pull.	15.6.56	Kedleston: 52°58'N. 1°33'W. (Derbyshire)
	transp.	15.6.56	Nr. Bodelern (Anglesey) 120m. W.
+		11.9.57	Kedleston
822	O pull.	11.7.57	Nr. Nuneaton: 52°32'N. 1°28'W. (Warwickshire) JW
+		2.10.57	Nr. Uttoxeter (Staffordshire) 31m. NW.

**Mute Swan** (*Cygnus olor*) (9)

There were four local recoveries and five at distances of 10-20 miles from the places of ringing.

**Golden Eagle** (*Aquila chrysaetos*) (1)

YB011 O pull. 20.5.56 " Galloway " RS  
v 7.5.57 (Peeblesshire)

This is the first recovery of this species. Precise localities of ringing and recovery are withheld in the interests of protection.

**Sparrowhawk** (*Accipiter nisus*) (5: 13 miles)

3014141 O pull. 26.6.56 Lisburn: 54°31'N. 6°02'W. (Antrim) JAB  
+ 29.1.57 Nr. Ballymena (Antrim) 35m. NNW.  
3010803 ad. ♂ 7.5.56 Dungeness: 50°55'N. 0°59'E. (Kent)  
× 14.4.57 Sherborne Park (Dorset) 155m. W.

**Marsh Harrier** (*Circus aeruginosus*) (2)

383505 O pull. 21.6.56 Hickling Broad: 52°45'N. 1°35'E. (Norfolk) ED  
+ ca.23.8.57 Amiens: 49°54'N. 2°18'E. (Somme) **France**  
383506 O pull. 21.6.56 Hickling Broad ED  
× 3.6.57 Nr. Spalding (Lincolnshire) 70m. W.

**Merlin** (*Falco columbarius*) (3: 10 miles)

385105 1stW. 3.9.57 Fair Isle: 59°32'N. 1°37'W. (Shetland)  
× 11.10.57 Nr. Bremerhaven: 53°33'N. 8°35'E. **Germany**  
3018864 O pull. 27.6.57 Dartmoor (Devon) AVS  
+ 9.11.57 Sérigny: 56°17'N. 1°01'W. nr. Andilly (Charente-Maritime)  
**France**

Precise locality of ringing withheld in the interests of protection.

**Kestrel** (*Falco tinnunculus*) (21: 50 miles)

That the Kestrel is a partial migrant is well brought out by the contrasting behaviour of the birds ringed at Moniaive (2), at Lorton (2), at Onchan Head (2, same brood) and at Everley (2, same brood).

3026506 O pull. 6.7.57 Haggerston: 55°42'N. 1°56'W., nr. Beal (Northumberland)  
MHBO  
/?/ 5.10.57 Nr. Beeston (Bedfordshire) 250m. SSE.  
394403 O pull. 13.7.56 Rathlin Island: 55°17'N. 6°15'W. (Antrim) DFC  
× 18.1.57 Nr. Cashel (Tipperary) 200m. SSW.  
3016515 O pull. 3.6.57 Nr. Moniaive: 55°11'N. 3°55'W. (Dumfriesshire) TT  
+ 9.11.57 Renay: 47°51'N. 1°11'E. (Loir-et-Cher) **France**  
3010074 O pull. 9.6.57 Moniaive TT  
× 22.11.57 Closeburn, Thornhill (Dumfriesshire) 7m. E.  
3030058 O pull. 16.6.57 Lorton: 54°37'N. 3°18'W. (Cumberland) RS  
+ 3.12.57 Nr. Ste.-Marie-du-Mont: 49°22'N. 1°14'W. (Manche)  
**France**  
3030062 O pull. 16.6.57 Lorton RS  
( ) 5.12.57 Bebington, Wirral (Cheshire) 86m. S.  
3005130 O pull. 30.6.57 Onchan Head: 54°11'N. 4°27'W., Isle of Man WSC  
+ 30.11.57 Gortin (Tyrone) 115m. WNW.  
3005131 O pull. 30.6.57 Onchan Head WSC  
× 28.11.57 Cérain: 43°06'N. 2°19'W. (Guipúzcoa) **Spain**

2251	O	pull.	20.6.57	New Holland: 53°42'N. 0°22'W. (Lincolnshire)	HVDB
	×		27.8.57	Nr. Billingham (Durham)	74m. NNW.
9594	O	pull.	21.7.57	Nr. Everley: 51°17'N. 1°44'W. (Wiltshire)	PJC
	+		3.11.57	Nr. Baccon: 47°53'N. 1°38'E. (Loiret)	France
9600	O	pull.	21.7.57	Nr. Everley	PJC
	+		30.12.57	Wootton, Isle of Wight (Hampshire)	42m. SE.

### Water Rail (*Rallus aquaticus*) (1)

1665	ad.		7.2.57	Abberton: 51°50'N. 0°53'E. (Essex)	
	+		30.11.57	Moulineaux: 49°21'N. 0°58'E., nr. Rouen (Seine-Maritime)	France

### Coot (*Fulica atra*) (17: 100 miles)

1515	ad. ♂		4.11.56	Hawkestone Park: 52° 53'N. 2° 40'W., nr. Wem (Shropshire)	WT
	+		28.2.57	Nr. Smithborough (Monaghan)	205m. WNW.
9597	ad.		26.1.55	Abberton: 51°50'N. 0°53'E. (Essex)	
	×		24.12.57	Nr. Hilversum: 52°13'N. 5°05'E. (N-Holland)	
13765	ad.		21.2.55	Abberton	
	v		24.4.56	Hauge: 56°15'N. 9°22'E., Kjellerup (Jutland)	Denmark
	+		26.1.57	Rockland St. Mary: 52° 32'N. 0°56'E. (Norfolk)	
14543	ad.		23.3.56	Abberton	
	+		8.5.57	Nr. Rhede: 53°04'N. 7°17'E. (Neidersachsen)	Germany
14590	ad.		22.8.56	Abberton	
	+		26.10.57	Isla de Buda: 40°42'N. 0°50'E., Ebro Delta (Tarragona)	Spain

The recoveries from Ireland and Spain are the first of this species from those countries.

### Oystercatcher (*Haematopus ostralegus*) (25: 50 miles)

18911	O	pull.	6.7.57	Fetlar: 60°36'N. 0°50'W. (Shetland)	EAG
	+		(16.11.57)	Millbrook (Cornwall)	720m. SSW.
4182	O	pull.	14.6.53	Fair Isle: 59°32'N. 1°37'W. (Shetland)	
	×		28.2.57	Walney Island (Lancashire)	380m. S.
24031	O	pull.	30.6.56	Dufftown: 57°27'N. 3°09'W. (Banffshire)	A&R
	×		13.4.57	Morecambe Bay (Lancashire)	230m. S.
9247	O	pull.	3.6.54	Kincraig: 57°07'N. 3°55'W. (Inverness-shire)	FCG
	/?		(24.12.57)	Cockerham, nr. Lancaster (Lancashire)	220m. SSE.
30607	O	pull.	16.6.57	Newtonmore: 57°04'N. 4°07'W. (Inverness-shire)	RP
	×		14.8.57	Nr. Wigtown	150m. S.
19721		f.g.	8.12.56	R. Conway: ca. 53°17'N. 3°50'W. (Caernarvonshire)	MAFF
	×		19.3.57	Midvag: ca. 62°00'N. 7°00'W. Faeroe Islands	
1889	O	pull.	27.7.53	Blakeney Point: 52°59'N. 0°59'E. (Norfolk)	NNT
	×		(30.1.57)	Netley, nr. Southampton (Hampshire)	170m. SW.

### Lapwing (*Vanellus vanellus*) (67)

7632	O	pull.	28.6.54	Nr. Harrogate: 53°59'N. 1°33'W. (Yorkshire)	Sa&W
	/?		20.1.57	Bayonne: 43°30'N. 1°28'W. (Basses-Pyrénées)	France
00702	O	pull.	20.7.56	Marston: 52°59'N. 0°41'W., nr. Grantham (Lincolnshire)	WMP
	+		10.3.57	Varaville: 49°15'N. 0°10'W. (Calvados)	France
1705	O	pull.	31.5.54	Tempsford: 52°10'N. 0°18'W. (Bedfordshire)	CFT
	+		23.2.57	Nr. Livorno: 43°33'N. 10°18'E., Italy	

277162 O pull. 23.6.54 Marlow: 51°34'N. 0°37'W. (Buckinghamshire) RFL  
 + 12.2.57 Nr. Croissanville: 49°07'N. 0°06'W. (Calvados) France

Three birds from Scotland and six from northern England, all ringed as pullus, were recovered in Ireland in December, January and early February. There are five other recoveries at distances of 35-80 miles from the place of ringing, and the remainder are local.

**Ringed Plover (*Charadrius hiaticula*) (3: 5 miles)**

S24459 f.g. 30.8.57 Spurn Point: 53°35'N. 0°06'E. (Yorkshire).  
 + 25.9.57 Châtelailon: 46°05'N. 1°05'W. (Charente-Maritime) France

**Snipe (*Capella gallinago*) (12: 50 miles)**

X87405 O pull. 18.7.54 Nr. Clitheroe: 53°53'N. 2°24'W. (Lancashire) JWA  
 + 9.11.57 Nr. Craughwell (Galway) 250m. WSW.  
 S33504 ad. 21.8.55 Abberton: 51°50'N. 0°53'E. (Essex)  
 + ca.6.2.57 Nr. Claremorris (Mayo) 430m. WNW.

**Jack Snipe (*Lymnocyptes minimus*) (2: 2 miles)**

S16270 f.g. 1.10.57 Nr. Wisbech: 52°44'N. 0°11'E. (Cambridgeshire) AEV  
 + 21.11.57 St. Amans: 44°40'N. 3°26'E. (Lozère) France

This is the third foreign recovery for this species, there being previous records from France and Spain.

**Green Sandpiper (*Tringa ochropus*) (1)**

V34185 ad. 20.7.57 Abberton: 51°50'N. 0°53'E. (Essex)  
 × 4.8.57 Nr. La Bisbal: 41°58'N. 3°01'E. (Gerona) Spain

This is the first recovery for this species.

**Common Sandpiper (*Tringa hypoleucos*) (2)**

S96645 ad. 19.8.57 Bardney: 53°13'N. 0°20'W. (Lincolnshire) ADT  
 + 25.8.57 Matozinhos: 41°11'N. 8°42'W. (Douro Litoral) Portugal  
 S72348 f.g. 25.7.56 Benacre: 52°24'N. 1°43'E. (Suffolk) HE&W.  
 × (14.6.57) Watendlath, nr. Keswick (Cumberland) 250m. NW.

S96645 is the first recovery of this species in Iberia.

**Redshank (*Tringa totanus*) (5: 50 miles)**

X59532 O pull. 13.6.54 Aberlady Bay: 56°01'N. 2°56'W. (East Lothian) H&M  
 v 6.12.57 West Kirby (Cheshire) 180m. SW.  
 X76478 ad. 10.2.54 Nr. Seahouses: 55°35'N. 1°39'W. (Northumberland) MHBO.  
 × 3.5.57 Leuchars (Fife) 70m. NW.  
 S75897 ad. 30.8.56 Nr. Sutton Bridge: 52°48'N. 0°12'E. (Lincolnshire) CDTM  
 + 16.7.57 Le Touquet: 50°31'N. 1°36'E. (Pas-de-Calais) France

**Greenshank (*Tringa nebularia*) (1)**

2009555 f.g. 8.9.57 Perry Oaks, Stanwell: 51°28'N. 0°28'W. (Middlesex) C&E  
 + 18.10.57 Fresnay en Retz: 47°02'N. 1°52'W. (Loire-Atlantique)  
 France

This is the first foreign recovery for this species. The only previous record is of a bird from Sutherland recovered in Co. Cork in 1926.

**Knot (*Calidris canutus*) (1)**

S55704 juv. 11.9.56 Rudha Ardvule: 57°15'N. 7°28'W., South Uist, Outer  
 Hebrides H&M  
 × 13.1.57 Nr. Holbrook (Suffolk) 500m. SE

**Dunlin** (*Calidris alpina*) (13: 30 miles)

V25187	1stW.	30.8.57	Holy Island: 55°42'N. 1°48'W. (Northumberland)	MHBO
	×	21.9.57	Hendaye: 43°22'N. 1°46'W. (Basses-Pyrénées)	France
V25418	ad.	1.9.57	Holy Island	MBHO
	+	9.11.57	Newtownards (Down) 165m. WSW.	
V25353	ad.	31.8.57	Nr. Seahouses: 55°35'N. 1°39'W. (Northumberland)	MHBO
	+	15.9.57	Nr. Grandcamp: 49°23'N. 1°01'W. (Calvados)	France
V21090	1stW.	19.8.55	Beadnell: 55°33'N. 1°37'W. (Northumberland)	MHBO
	+	15.5.57	Hendaye, France	
V4824	ad.	5.10.57	Spurn Point: 53°35'N. 0°06'E. (Yorkshire)	
	v	25.10.57	Cark Sands, Morecambe Bay (Lancashire) 130m. WNW.	
V6648	ad.	29.8.57	Bardney: 53°13'N. 0°20'W. (Lincolnshire)	ADT
	[?]	24.11.57	Moulay bou Selham: 34°58'N. 6°13'W. Morocco	
V1517	f.g.	26.8.56	Blithfield: 52°49'N. 1°56'W. (Staffordshire)	NH
	+	(19.4.57)	Bassin d'Arcachon: 44°41'N. 1°11'W. (Gironde)	France

There are no previous recoveries from Africa. S21090 was identified sub-specifically as *C. a. alpina*; V25418 as *C. a. schinzii*.

**Sanderling** (*Crocethia alba*) (1)

V35414	ad.	2.9.57	Holy Island: 55°42'N. 1°48'W. (Northumberland)	MHBO
	+	2.10.57	Poti: 42°08'N. 41°39'E. (Georgia)	U.S.S.R.

This remarkable recovery is the first for this species. Poti is ca. 2,200 miles south-east of Holy Island, the most direct course lying mainly overland. According to *The Handbook of British Birds* the nearest breeding grounds are Greenland, Spitzbergen and the Taimyr peninsula; the wintering areas including South Africa, the shores of the Indian Ocean, and South-East Asia.

**Ruff** (*Philomachus pugnax*) (1)

V5881	ad. ♂	22.8.56	Cambridge: 52°12'N. 0°07'E. CDTM	
	[?]	22.5.57	Nosovoë: 68°20'N. 54°30'E. (Arkhangel)	U.S.S.R.

This is the first foreign recovery of a Ruff. The distance from Nosovoë to Cambridge is over 2,000 miles, and it is interesting that birds from the N. Russian breeding grounds may travel so far west on migration.

**Stone Curlew** (*Burhinus oedicnemus*) (1)

V17802	O pull.	14.6.57	Dungeness: 50°55'N. 0°59'E. (Kent)	
	+	14.10.57	Torrente: 39°27'N. 0°28'W. (Valencia)	Spain

**Arctic Skua** (*Stercorarius parasiticus*) (4: 10 miles)

V19785	O pull.	7.7.54	Fair Isle: 59°32'N. 1°37'W. (Shetland)	
	×	5.6.57	Spiggie (Shetland) 30m. NNE.	
V19822	O pull.	22.7.54	Fair Isle	
	()	3.11.57	Nr. Mossâmedes: 15°10'S. 12°10'E., Angola	

This is the second recovery of this species in Angola.

**Great Black-backed Gull** (*Larus marinus*) (19: 50 miles)

V263	O pull.	11.7.56	St. Kilda: 57°49'N. 8°34'W., Outer Hebrides	DRW
	×	(18.4.57)	Ballymoney (Antrim) 190m. SE.	
V163	O pull.	17.6.57	Nr. Nigg: 57°41'N. 3°59'W. (Ross-shire)	JL
	×	ca.18.12.57	Elie (Fife) 115m. SSE.	

411411	O	pull.	3.7.56	Sheep Island, nr. Ballintoy: 55°16'N. 6°21'W. (Antrim)
		( )	(31.5.57)	JAB Off Dunvegan, Isle of Skye, Inner Hebrides. 150m. N.
AF7177	O	pull.	24.5.56	Mochrum Loch: 54°47'N. 4°34'W. (Wigtownshire) R
	×		13.1.57	Southport (Lancashire) 112m. SE.
411796	O	pull.	6.7.57	Mochrum Loch DS
	+		30.12.57	Nr. Lurgan (Armagh) 70m. WSW.
410755	O	pull.	29.6.57	Copeland: 54°40'N. 5°32'W. (Down)
	×		8.12.57	Carsethorn, Kirkbean (Dumfriesshire) 76m. ENE.

### Lesser Black-backed Gull (*Larus fuscus*) (62)

Thirty-two birds were recovered in the British Isles, fifteen at distances of more than 20 miles from the ringing locality.

AF6157	O	pull.	10.8.53	Flanders Moss: 56°13'N. 4°20'W. (Stirlingshire) MHBO
	×		22.7.57	Puerto de Mazarrón: 37°34'N. 1°15'W. (Murcia) <b>Spain</b>
AH7329	O	pull.	7.7.56	Nr. Lancaster: 54°03'N. 2°35'W. (Lancashire) W&M
	×		5.9.57	Voorne: ca.51°50'N. 4°15'E. (Z-Holland)

The remaining 28 foreign recoveries are summarized in Table E.

TABLE E—COUNTRY AND MONTH OF RECOVERY OF LESSER BLACK-BACKED GULLS (*Larus fuscus*)

Country of recovery	Sept.	Oct.	Nov.	Dec.	Jan.	Feb.	Mar.	Apr.	May	June	July	Aug.	Total
France ...											1	1	2
Portugal & W. Spain	2	4	4	2	2	4	1	1		2		2	24
Morocco ...							2						2

See footnote to Table A.

### Herring Gull (*Larus argentatus*) (94: 100 miles)

55 recoveries were at distances of up to ten miles from the ringing localities. Including those published below, only 12 recoveries show movement of more than fifty miles.

405609		ad.	20.10.52	Isle of May: 56°11'N. 2°33'W. (Fife)
	×		20.5.57	Sortland: 68°44'N. 15°25'E., Vesterålen (Nordland)
				<b>Norway</b>
AJ1698		juv.	29.8.57	Isle of May
	v		23.10.57	Cark Sands, Morecambe Bay (Lancashire) 140m. S.
AF9279	O	pull.	8.7.55	Bass Rock: 56°04'N. 2°38'W. (East Lothian) MHBO
	×		ca.9.6.57	Redcar (Yorkshire) 115m. SE.
AJ1958	O	pull.	24.6.57	Lundy: 51°12'N. 4°40'W. (Devon)
	×		3.11.57	Dibden, nr. Southampton (Hampshire) 142m. ESE.

The following recovery is the first of its kind, but because the chance of misidentification cannot be excluded completely the record must be treated with reserve.

AJ4015	O	pull.	2.7.57	Nr. Rosemarkie: 57°36'N. 4°07'W. (Ross-shire) JL
	v		(10.10.57)	Nr. Fastnet Rock (off Cork) ca.480m. SW.

### Common Gull (*Larus canus*) (4)

383315		f.g.	26.2.55	Chelmsford: 51°44'N. 0°28'E. (Essex) P&B
	×		15.7.57	Villose: 55°01'N. 12°08'E. (Sjælland) <b>Denmark</b>

4566	ad.	21.2.56	Skokholm: 51°42'N. 5°16'W. (Pembrokeshire)
×		25.6.57	Rundøy: 62°25'N. 5°38'E. (More og Romsdal) <b>Norway</b>
10520	1stW.	22.2.56	Sandwich: 51°17'N. 1°20'E. (Kent) SBRS
×		2.3.57	Nr. Oosterend: 53°05'N. 4°52'E., Texel (N-Holland)
X5922	ad.	22.2.55	Dungeness: 50°55'N. 0°59'E. (Kent)
×		25.6.57	Lidköping: 58°30'N. 13°10'E. (Skaraborg) <b>Sweden</b>

**Black-headed Gull (*Larus ridibundus*) (282)**

3128	1stW.	7.2.54	Nr. Holt: 52°56'N. 1°07'E. (Norfolk) GHCB
+		0.7.56	Hadsund: 56°43'N. 10°08'E. (Jutland) <b>Denmark</b>
32141	O pull.	14.6.57	Nr. Ludham: 52°42'N. 1°33'E. (Norfolk) HE&W
v		19.11.57	El Ferrol del Caudillo: 43°29'N. 8°14'W. (Coruña) <b>Spain</b>
33915	juv.	13.8.55	Abberton: 51°50'N. 0°53'E. (Essex)
×		(19.9.57)	Rudköbing: 54°57'N. 10°43'E. (Langeland) <b>Denmark</b>
1736	O pull.	5.7.55	Nr. Brightlingsea: 51°49'N. 1°02'E. (Essex) RWA
×		ca.20.3.57	Nr. Oran: 35°45'N. 0°38'W., <b>Algeria</b>
004394	O pull.	17.6.56	Nr. Brightlingsea RWA
+		23.2.57	Nr. Casablanca: ca.33°25'N. 7°45'W., <b>Morocco</b>
15917	O pull.	23.6.57	Nr. Brightlingsea RWA
+		13.11.57	Zalamea de la Serena: 38°40'N. 5°39'W. (Badajoz) <b>Spain</b>
15968	O pull.	23.6.57	Nr. Brightlingsea RWA
+		13.9.57	Petiville: 49°26'N. 0°36'E. nr. Lillebonne (Seine-Maritime) <b>France</b>
15884	O pull.	24.6.56	Nr. Brightlingsea RWA
+		25.12.57	Gondomar: 41°10'N. 8°35'W. (Douro Litoral) <b>Portugal</b>
3307	ad.	3.2.56	Chelmsford: 51°44'N. 0°28'E. (Essex) P&B
×		11.2.57	Culemborg: 51°58'N. 5°14'E. (Gelderland) <b>Holland</b>
3318	f.g.	3.2.56	Chelmsford P&B
/?		7.5.57	Hornborgasjön: 58°20'N. 13°35'E. (Skaraborg) <b>Sweden</b>
0872	ad.	8.11.52	Hammersmith: 51°30'N. 0°14'W. (London) LNHS
×		19.5.57	Ummanz: 54°27'N. 13°08'E., Rügen, <b>Germany</b>
31392	O pull.	16.6.57	Stoke: 51°27'N. 0°38'E. (Kent) F&M
×		27.7.57	Paimboeuf: 47°17'N. 2°01'W. (Loire Atlantique) <b>France</b>
3218	1stW.	18.2.56	Sandwich: 51°17'N. 1°20'E. (Kent) DFH
+		14.6.57	Nr. Haderslev: 55°15'N. 9°30'E. (Jutland) <b>Denmark</b>

See also Map 1 on page 472.

**Kittiwake (*Rissa tridactyla*) (38: 100 miles)**

33785	O pull.	19.7.57	Nr. St. Abb's Head: 55°55'N. 2°08'W. (Berwickshire) IJP
/?		22.8.57	Scarborough: (Yorkshire) 130m. SE.
4703	O pull.	26.6.55	Farne Islands: 55°37'N. 1°37'W. (Northumberland) ND&N
×		(2.1.57)	St. Pierre: 46°45'N. 56°12'W., <b>Newfoundland</b>
36776	ad.	19.6.56	Farne Islands ND&N
×		3.2.57	Bishopton, nr. Stratford-on-Avon (Warwickshire) 230m. S.
36864	ad.	19.6.56	Farne Islands ND&N
×		6.6.57	Bridlington Harbour (Yorkshire) 120m. SE.
36877	ad.	19.6.56	Farne Islands ND&N
()		17.10.57	10 miles W. of Måseskär lighthouse: 58°06'N. 11°20'E. (Bohus) <b>Sweden</b>
42703	ad.	19.6.56	Farne Islands ND&N
×		24.3.57	Nr. Freckleton (Lancashire) 135m. SSW.

3012302	O	pull.	27.6.56	Farne Islands ND&N
	+		6.8.57	Egaluk Fjord: <i>ca.</i> 65°00'N. 52°10'W., Sukkertoppen Greenland
AT42960	×	ad.	3.7.56	Farne Islands ND&N
			31.1.57	Crosby, <i>nr.</i> Liverpool (Lancashire) 155m. SSW.

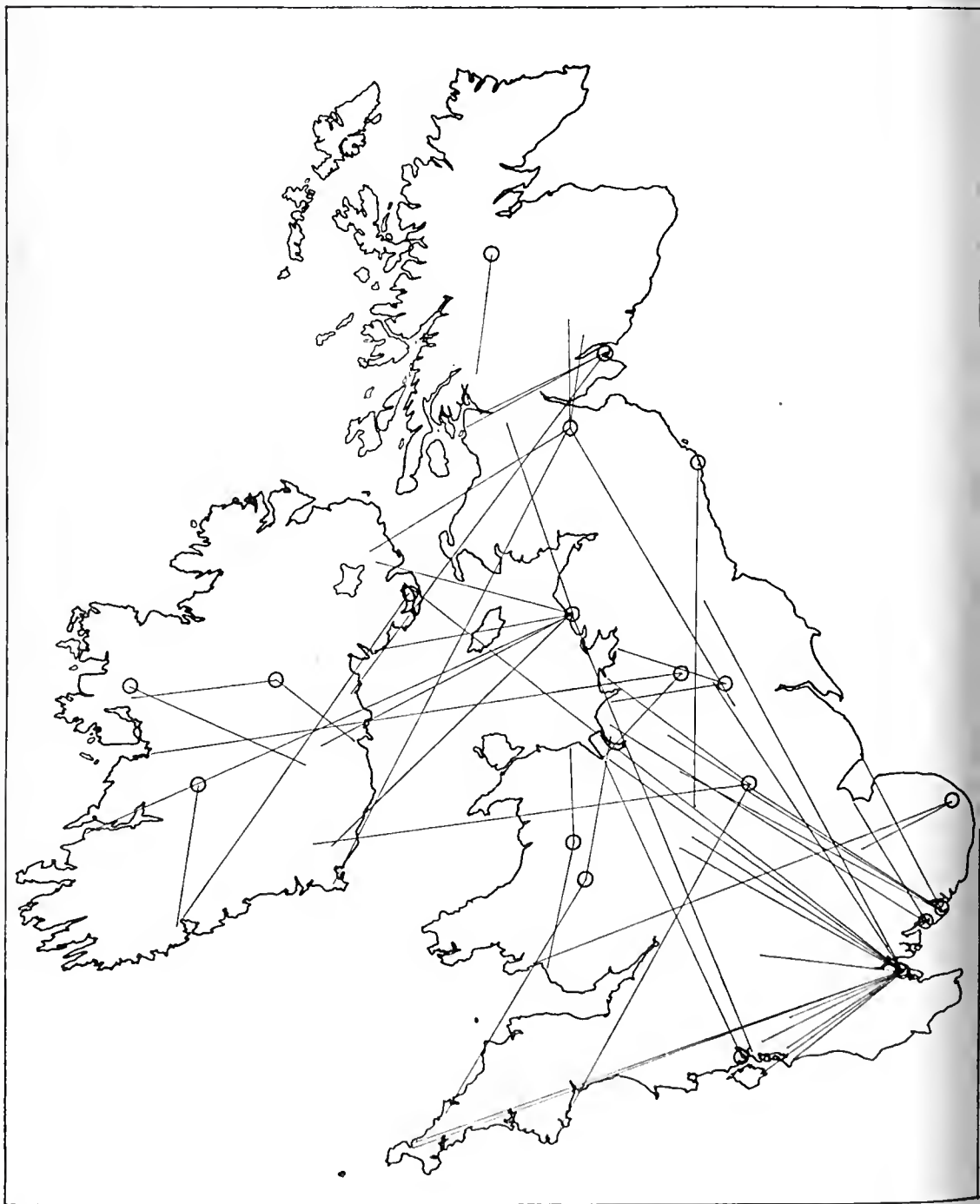

MAP I—RECOVERIES OF BLACK-HEADED GULLS (*Larus ridibundus*) IN THE BRITISH ISLES  
The places of ringing are indicated by circles. Recoveries showing movement of less than 50 miles are omitted.



012233	O pull.	7.7.56	Farne Islands ND&N
	()	(20.1.57)	Grand Banks: <i>ca.</i> 46°00'N. 52°00'W., <b>Newfoundland</b>
012398	O pull.	7.7.56	Farne Islands ND&N
	×	29.9.57	North Sea: 53°16'N. 1°18'E., <i>ca.</i> 225m. SE.
017617	O pull.	7.7.56	Farne Islands ND&N
	+	25.7.57	Atangmik: <i>ca.</i> 65°00'N. 52°06'W., <b>Sukkertoppen, Greenland</b>
017697	O pull.	7.7.56	Farne Islands ND&N
	+	9.3.57	Nr. Palermo: 38°08'N. 13°23'E., <b>Sicily</b>
017768	O pull.	12.7.56	Farne Islands ND&N
	()	15.2.57	Nr. Flushing: 51°27'N. 3°35'E. (Zeeland) <b>Holland</b>
012099	O pull.	29.6.57	Farne Islands ND&N
	+	5.9.57	North Sea: 55°48'N. 5°40'E.
023883	O pull.	6.7.57	Farne Islands ND&N
	/?/	1.11.57	Nordre Rønner: 57°22'N. 10°54'E., <b>Denmark</b>
023956	O pull.	21.7.57	Farne Islands ND&N
	×	28.8.57	Hirtshals: 57°36'N. 9°58'E. (Jutland) <b>Denmark</b>
04886	O pull.	14.7.54	Lundy: 51°12'N. 4°40'W. (Devon)
	()	<i>ca.</i> 22.5.57	Libos: 44°29'N. 0°57'E. (Lot-et-Garonne) <b>France</b>

03017697 is the first bird of this species to be recovered in the Mediterranean. Note that Libos (364886) is far inland.

#### Common Tern (*Sterna hirundo*) (20: 25 miles)

022436	O pull.	14.7.57	Scroby Sands, Great Yarmouth: 52°36'N. 1°45'E. (Norfolk) HD
	×	17.8.57	Nr. Havrvg: 55°54'N. 8°08'E. (Jutland) <b>Denmark</b>
08017	O pull.	23.6.57	Stoke: 51°27'N. 0°38'E. (Kent) F&M
	+	1.9.57	St. Valery-sur-Somme: 50°11'N. 1°38'E. (Somme) <b>France</b>
00300	O pull.	3.7.57	Rye Harbour: 50°56'N. 0°46'E. (Sussex) DDH
	×	8.9.57	Val-André: 48°36'N. 2°33'W. (Côtes-du-Nord) <b>France</b>
08691	O pull.	8.7.57	Rye Harbour DBO
	+	<i>ca.</i> 20.11.57	Barbate de Franco: 36°11'N. 5°55'W. (Cádiz) <b>Spain</b>

#### Arctic Tern (*Sterna macrura*) (76: 50 miles)

02573	O pull.	25.7.55	Farne Islands: 55°37'N. 1°37'W. (Northumberland) ND&N
	×	summer 57	Nr. Otta: 61°46'N. 9°33'E. (Opland) <b>Norway</b>
08525	O pull.	7.7.56	Farne Islands ND&N
	+	24.9.57	Nr. Keta: 5°55'N. 1°01'E., <b>Ghana</b>
05793	O pull.	5.7.57	Farne Islands ND&N
	×	16.8.57	Port Seton (East Lothian) 55m. WNW.
08955	O pull.	6.7.57	Farne Islands ND&N
	()	23.9.57	Nr. Tamanar: 31°03'N. 9°42'W., <b>Morocco</b>
08547	O pull.	14.7.57	Farne Islands ND&N
	×	1.9.57	Bad Zwischenahn: 53°12'N. 8°00'E. (Niedersachsen) <b>Germany</b>
08731	O pull.	20.7.57	Farne Islands ND&N
	()	29.10.57	Baia Farta: 12°36'S. 13°12'E., nr. Benguela, <b>Angola</b>
08866	juv.	20.7.57	Farne Islands ND&N
	×	31.8.57	Tayport (Fife) 73m. NW.
08728	O pull.	20.7.57	Farne Islands ND&N
	×	<i>ca.</i> autumn 57	Nr. Münster: 51°58'N. 7°37'W. (Westfalen) <b>Germany</b>
08632	O pull.	4.8.57	Farne Islands ND&N
	×	5.9.57	Balmedie (Aberdeenshire) 105m. N.
08634	O pull.	4.8.57	Farne Islands ND&N
	×	27.8.57	At sea, 16 miles S.E. of R. Tyne <i>ca.</i> 55m. SSE.

**Roseate Tern** (*Sterna dougallii*) (2: 20 miles)

- X58776 O pull. 19.7.55 Firth of Forth: *ca.*56°10'N. 2°50'W. MOC  
 × 27.9.57 *Nr.* Ardmillan (Down) 135m. SW.

**Little Tern** (*Sterna albifrons*) (6: 10 miles)

- W40610 O pull. 17.7.55 Aberlady Bay: 56°01'N. 2°51'W. (East Lothian) H&M  
 × 23.6.57 Walney Island (Lancashire) 135m. S.

**Sandwich Tern** (*Sterna sandvicensis*) (49: 50 miles)

- 279339 O pull. 26.6.53 Lady Island: 55°31'N. 4°44'W. (Ayrshire) SSPB  
 × 20.8.57 Portrane (Dublin) 150m. SSW.  
 276545 O pull. 8.7.54 Farne Islands: 55°37'N. 1°37'W. (Northumberland)  
 ND&N  
 + 30.9.57 Po Estuary: *ca.*44°55'N. 12°30'E. (Rovigo) **Italy**  
 276144 O pull. 4.7.55 Farne Islands ND&N  
 v 28.4.57 Simonstown: 34°12'S. 18°26'E. (Cape Province) **South  
 Africa**  
 276741 O pull. 5.7.55 Farne Islands ND&N  
 × 2.8.57 *Nr.* Hamburg: 53°33'N. 10°00'E., **Germany**  
 2000275 O pull. 27.6.56 Farne Islands ND&N  
 + 1.7.57 Dakar: 14°40'N. 17°26'W., **Senegal**  
 2006226 O pull. 29.6.57 Farne Islands ND&N  
 × (20.8.57) Pagham Harbour (Sussex) 340m. SSE.  
 2006656 O pull. 14.7.57 Farne Islands ND&N  
 × 1.9.57 St. Margaret's Bay (Fife) 70m. NW.  
 291709 O pull. 17.6.56 Killyleagh: 54°24'N. 5°39'W. (Down) PPM  
 + 13.7.57 *Nr.* Keta: 5°55'N. 1°01'E., **Ghana**

In addition to the above foreign recoveries, which are from unusual localities or at interesting dates, 17 other birds were recovered abroad:—France, 1; Spain, 1; Portugal, 1; Senegal, 1; Sierra Leone, 1; Ivory Coast, 1; Ghana, 7; Nigeria, 2; Angola, 1 and South Africa, 1.

**Razorbill** (*Alca torda*) (26: 100 miles)

- AX9203 ad. 23.4.52 Great Saltee: 52°07'N. 6°35'W. (Wexford)  
 × *mid*-4.57 Dawlish Warren (Devon) 170m. SE.  
 AT16198 O pull. 3.7.53 Skokholm: 51°42'N. 5°16'W. (Pembrokeshire)  
 × (27.11.57) *Nr.* Mulrany (Mayo) 250m. NW.  
 AT40106 ad. 27.6.56 Skokholm  
 × 19.1.57 Roscoff: 48°43'N. 3°59'W. (Finistère) **France**  
 AT40388 O pull. 3.7.56 Skokholm  
 × 9.2.57 Seaton (Devon) 114m. SE.  
 AT40392 O pull. 3.7.56 Skokholm  
 + *ca.*25.3.57 Orio: 43°16'N. 2°07'W. (Guipúzcoa) **Spain**  
 AT40517 O pull. 5.7.56 Skokholm  
 + *ca.*11.3.57 Bilbao: 43°15'N. 2°56'W. (Vizcaya) **Spain**  
 AT10912 O pull. 2.7.53 Lundy: 51°12'N. 4°40'W. (Devon)  
 + 9.10.57 *Off* Oksø lighthouse: 58°05'N. 8°07'E. (Vest Agder)  
**Norway**  
 AT18420 O pull. 4.7.55 Lundy  
 + *ca.*20.1.57 *Nr.* Povoia de Varzim: 41°22'N. 8°46'W. (Douro  
 Litoral) **Portugal**

T35972	O	pull.	24.6.56	Lundy
	×		3.7.57	Ste. Anne-la-Palud: 48°06'N. 4°17'W. (Finistère) <b>France</b>
T35973	O	pull.	24.6.56	Lundy
	×		10.1.57	Nr. Allonby (Cumberland) 250m. N.
T43366	O	pull.	24.6.57	Lundy
	×		30.10.57	Kimmeridge (Dorset) 114m. ESE.
T43385	O	pull.	26.6.57	Lundy
	()		20.11.57	Nr. Aviles: 43°33'N. 5°55'W. (Oviedo) <b>Spain</b>

**Guillemot (*Uria aalge*) (16: 100 miles)**

T26525		juv.	26.6.55	Isle of May: 56°11'N. 2°33'W. (Fife)
	+		23.1.57	Nr. Torbjørnskjær: 59°00'N. 10°46'E., Oslofjord, <b>Norway</b>
T26604	O	pull.	26.6.57	Isle of May
	+		29.9.57	Nr. Ferder lighthouse: 59°00'N. 10°32'E., Oslofjord, <b>Norway</b>
T35960	O	pull.	23.6.56	Lundy: 51°12'N. 4°40'W. (Devon)
	+		29.9.57	Nr. Cabo Higuier: 43°24'N. 1°48'W. (Guipúzcoa) <b>Spain</b>
T14900	O	pull.	20.7.56	Lundy
	×		4.3.57	Aberdaron (Caernarvonshire) 110m. N.
T43346	O	pull.	14.6.57	Lundy
	×		13.8.57	Rocquaine Bay, Guernsey, Channel Islands 150m. SE.
T15015	O	pull.	17.6.57	Lundy
	×		(1.11.57)	Little Bispham, Blackpool (Lancashire) 195m. NNE.

**Black Guillemot (*Uria grylle*) (1)**

000352	O	pull.	7.7.57	Bray Head: 53°12'N. 6°06'W. (Wicklow) RGW
	×		29.9.57	Ballyteige Bay (Wexford) 70m. SSW.

**Puffin (*Fratercula arctica*) (4: 10 miles)**

T29637	O	pull.	10.7.55	Skokholm: 51°42'N. 5°16'W. (Pembrokeshire)
	×		2.4.57	Gozon: 43°37'N. 5°48'W. (Oviedo) <b>Spain</b>
T48167	O	pull.	15.7.57	Skokholm
	×		21.7.57	Bréhal: 48°54'N. 1°30'W., nr. Granville (Manche) <b>France</b>
T48221	O	pull.	16.7.57	Skokholm
	×		22.9.57	Dungarvan (Waterford) 100m. WNW.

**Woodpigeon (*Columba palumbus*) (34: 50 miles)**

002310	O	pull.	9.7.57	Nr. Sidlesham: 50°47'N. 0°48'W. (Sussex) AA
	+		(17.12.57)	St. Malon-sur-Mel: 48°05'N. 2°07'W. (Ille-et-Vilaine) <b>France</b>
002312	O	pull.	26.7.57	Sidlesham AA
	+		22.12.57	St. Ouen-la-Rouerie: 48°29'N. 1°28'W. (Ille-et-Vilaine) <b>France</b>

**Turtle Dove (*Streptopelia turtur*) (6: 10 miles)**

02208	O	pull.	19.6.57	Weybourne: 52°57'N. 1°09'E. (Norfolk) CBO
	+		1.9.57	Gibraléon: 37°23'N. 6°58'W. (Huelva) <b>Spain</b>
03319		ad.	14.6.56	Swaffham: 52°39'N. 0°41'E. (Norfolk) CBO
	+		26.4.57	St. Estèphe: 45°17'N. 0°46'W. (Gironde) <b>France</b>
03355		ad.	14.6.55	Abberton: 51°50'N. 0°53'E. (Essex)
	+		24.5.57	Le Verdun: 45°33'N. 1°04'W. (Gironde) <b>France</b>
03393		ad.	18.6.55	Abberton
	+		5.5.57	Soulac: 45°31'N. 1°06'W. (Gironde) <b>France</b>

- 272852 ad. 21.5.55 Dungeness: 50°55'N. 0°59'E. (Kent)  
+ 0.5.57 Grayan: 45°27'N. 1°07'W. (Gironde) **France**

**Cuckoo (*Cuculus canorus*) (3: 10 miles)**

- 299561 juv. 28.6.57 Nr. Seahouses: 55°35'N. 1°39'W. (Northumberland) MHBO  
+ 4.8.57 Nr. Hasselt: 50°56'N. 5°20'E. (Limburg) **Belgium**  
262445 O pull. 11.6.54 Box Hill: 51°15'N. 0°19'W. (Surrey) B&T  
v 29.5.57 Nr. Luton (Bedfordshire) 42m. N.

**Swift (*Apus apus*) (34: 25 miles)**

- KE798 O pull. 4.7.52 Cley: 52°58'N. 1°03'E. (Norfolk)  
v ca.2.9.57 Nr. Chartres: 48°27'N. 1°30'E. (Eure-et-Loire) **France**  
A35240 O pull. 8.7.55 Oxford: 51°45'N. 1°15'W. EGI  
× (7.7.57) Cheltenham (Gloucestershire) 35m. WNW.  
C95452 O pull. 16.7.57 Oxford EGI  
× 15.8.57 Swalecliffe, Whitstable (Kent) 100m. ESE.

**Green Woodpecker (*Picus viridis*) (2: 5 miles)**

- 264813 ad. ♀ 13.1.55 Cholsey: 51°34'N. 1°09'W. (Berkshire) OOS  
× 25.2.57 Steventon (Berkshire) 8m. WNW.

**Great Spotted Woodpecker (*Dendrocopos major*) (4: 5 miles)**

- 266875 ad. ♀ 21.5.56 Sevenoaks: 51°16'N. 0°12'E. (Kent) P&P  
× 30.11.57 Bexley Heath (Kent) 12m. N.

**Wryneck (*Jynx torquilla*) (1)**

- S24613 ad. 4.9.56 Spurn Point: 53°35'N. 0°06'E. (Yorkshire)  
+ 27.5.57 Nr. Sorsele: 65°50'N. 16°32'E. (Västerbotten) **Sweden**

This is the first foreign recovery of a Wryneck and is of considerable interest. The recovery locality is near the northern limit of the species. The bird was ringed at the time of one of the greatest drift arrivals of northern species in recent years and may well have been involved in that movement.

**Swallow (*Hirundo rustica*) (42: 25 miles)**

- CBS43 O pull. 20.6.57 Carnforth: 54°08'N. 2°47'W. (Lancashire) JAGB  
× (31.12.57) Kinross: 26°25'S. 29°05'E. (Transvaal) **South Africa**  
C26574 O pull. 6.7.57 Kington: 52°12'N. 3°02'W. (Herefordshire) RHB  
+ (30.10.57) Kivunda: 4°20'S. 14°20'E., nr. Luozi, **Belgian Congo**  
E20232 ad. 19.9.57 Great Saltee: 52°07'N. 6°35'W. (Wexford)  
× 6.10.57 Vouharte: 45°26'N. 0°14'E. (Charente) **France**  
C24301 O pull. 30.6.56 Sandwich: 51°17'N. 1°20'E. (Kent) D&W  
( ) 20.6.57 Gaurain-Ramecroix: 50°35'N. 3°29'E. (Hainaut) **Belgium**  
A15330 O pull. 1.7.55 Hythe: 51°05'N. 1°05'E. (Kent) DBO  
( ) 4.10.57 Tetuán: 35°34'N. 5°23'W., **Spanish Morocco**

**Sand Martin (*Riparia riparia*) (7: 15 miles)**

- LJ469 ad. 13.7.55 Kirknewton: 55°34'N. 2°08'W. (Northumberland) MHBO  
× (29.8.57) St. Julien-Beychevelle: 45°11'N. 0°44'W. (Gironde) **France**

**Raven (*Corvus corax*) (7: 50 miles)**

- 410721 O pull. 28.4.56 Copeland Islands: 54°40'N. 5°32'W. (Down)  
( ) 26.3.57 Nr. Campbelltown (Argyllshire) 50m. N.

**Rook** (*Corvus frugilegus*) (49: 20 miles)

965	O	pull.	28.4.56	Castledillon: 54°23'N. 6°37'W. (Armagh)	JAB
	/?		20.2.57	Nr. Pomeroy (Tyrone) 20m. NW.	
983	O	pull.	28.4.56	Castledillon	JAB
	×		12.4.57	Nr. Killough (Down) 35m. E.	

**Jackdaw** (*Corvus monedula*) (50: 20 miles)

151	+	ad.	16.5.57	Copeland: 54°40'N. 5°32'W. (Down)	
			29.6.57	Lochinch, nr. Stranraer (Wigtownshire) 27m. ENE.	

**Chough** (*Pyrrhocorax pyrrhocorax*) (1)

53	O	pull.	11.6.56	Bardsey: 52°46'N. 4°48'W. (Caernarvonshire)	
	×		7.2.57	Portmadoc (Caernarvonshire) 29m. ENE.	

**Great Tit** (*Parus major*) (73: 20 miles)

720	O	pull.	25.5.57	Mundford: 52°31'N. 0°39'E., nr. Thetford (Norfolk)	CRD
	v		12.10.57	Hargrave, nr. Bury St. Edmunds (Suffolk) 20m. S.	

## 1958 RECOVERIES (see page 450)

768	×	f.g.	19.10.57	Spurn Point: 53°35'N. 0°06'E. (Yorkshire)	
			4.3.58	Bridlington (Yorkshire) 35m. NNW.	
572	()	f.g.	30.11.57	East Tilbury: 51°28'N. 0°26'E. (Essex)	HE&W
			12.3.58	Aubers: 50°36'N. 2°50'E. (Nord) France	
463	()	f.g. ♀	19.10.57	Kingsgate: 51°23'N. 1°27'E. (Kent)	DCHW
			4.4.58	Nr. Oifranville: 49°51'N. 1°01'E. (Seine-Maritime) France	
559	×	f.g.	3.11.57	Eastbourne: 50°46'N. 0°17'E. (Sussex)	DDH
			5.3.58	Maidstone (Kent) 35m. NNE.	
613	v	f.g. ♀	26.11.57	Eastbourne	J&AP
			27.3.58	Dungeness (Kent) 30m. ENE.	

**Blue Tit** (*Parus caeruleus*) (275: 20 miles)

175	×	ad. ♂	7.10.57	Gibraltar Point: 53°06'N. 0°21'E. (Lincolnshire)	
			12.10.57	Barton-on-Humber (Lincolnshire) 50m. NW.	
397	v	pull.	17.6.56	Chartley: 52°51'N. 1°59'W., nr. Stafford	AHJ
			18.2.57	Nuneaton (Warwickshire) 30m. SE.	
518	×	1stW.	24.10.57	Leicester: 52°38'N. 1°05'W.	L&R
			(8.11.57)	Nr. Arnold (Nottinghamshire) 25m. N.	
879	×	pull.	21.5.57	Higham: 52°33'N. 1°26'W., nr. Hinckley (Leicestershire)	JW
			22.11.57	Brimington: nr. Chesterfield (Derbyshire) 48m. N.	
428	×	pull.	26.5.57	Farnham Common: 51°34'N. 0°36'W. (Buckinghamshire)	ACF
			7.10.57	Oxford 29m. WNW.	
590	×	juv.	6.7.57	Cholsey: 51°34'N. 1°09'W. (Berkshire)	OOS
			15.10.57	Macclesfield (Cheshire) 122m. NNW.	
561	v	juv.	17.8.57	Tadworth: 51°18'N. 0°13'W. (Surrey)	RCH
			26.8.57	ibid	
	v		16.10.57	Thame (Oxfordshire) 44m. NW.	

A23167	ad.	1.4.55	Sevenoaks: 51°16'N. 0°12'E. (Kent) P&P
	v	27.2.57	Wembdon, Bridgwater (Somerset) 140m. W.
E46667	juv.	11.10.57	Dungeness: 50°55'N. 0°59'E. (Kent)
	×	4.11.57	Seven Kings, Ilford, (Essex) 57m. NW.
C79816	ad. ♀	29.1.57	Eastbourne: 50°46'N. 0°17'E. (Sussex) DDH
	×	(29.4.57)	Nr. Goudhurst (Kent) 25m. NNE.
C82067	f.g.	8.10.57	Hengistbury Head: 50°43'N. 1°45'W., nr. Christchurch
	×	(27.11.57)	(Hampshire) FRC Rainworth, nr. Mansfield (Nottinghamshire) 165m. NNE.
E14546	f.g.	8.10.57	St. Agnes: 49°53'N. 6°21'W. Scilly (Cornwall) SABO
	×	12.10.57	Off Tuskar Rock (Wexford) 160m. N.

## 1958 RECOVERIES (see page 450)

C96348	f.g.	29.9.57	Nr. Wellington: 54°42'N. 2°30'W. (Shropshire) ELEW
	×	9.4.58	Newnham Bridge, nr. Tenbury (Worcestershire) 25m. S.
E74041	f.g.	15.12.57	Llanrwst: 53°08'N. 3°48'W. (Denbighshire) AEM
	()	18.4.58	Nr. Abergavenny (Monmouthshire) 93m. SSE.
E68218	1stW.♀	22.12.57	Nuneaton: 52°32'N. 1°28'W. (Warwickshire) JW
	×	13.4.58	Rottingdean (Sussex) 130m. SSE.
26096	ad.	17.11.57	Clent: 52°24'N. 2°06'W. (Worcestershire) CAN
	×	13.4.58	Nr. Abergavenny (Monmouthshire) 46m. SW
E53331	f.g.	27.10.57	Walberswick: 52°18'N. 1°41'E. (Suffolk) DBC
	×	15.4.58	Little Plumstead, Norwich (Norfolk) 25m. NNW.
C35928	juv.	18.8.57	Welwyn Garden City: 51°48'N. 0°12'W. (Hertfordshire)
	v	31.3.58	DJTH Attenborough (Nottinghamshire) 85m. NW.
28062	f.g.	7.12.57	Worcester Park: 51°24'N. 0°15'W. (Surrey) WDP
	×	(8.3.58)	Horsham (Sussex) 21m. S.
C57423	ad.	12.10.57	Morden: 51°24'N. 0°12'W. (Surrey) MJC
	×	(18.4.58)	Northchapel (Sussex) 30m. SW.
E46596	1stW.	9.10.57	Dungeness: 50°55'N. 0°59'E. (Kent)
	×	(14.1.58)	Midhurst (Sussex) 72m. W.
E46652	1stW.	11.10.57	Dungeness
	v	20.3.58	"Le Havre" light-vessel: 49°32'N. 0°09'W. (off Seine-Maritime) France
ES0252	ad.	16.11.57	Southwick: 50°50'N. 0°14'W. (Sussex) BAEM
	×	ca.28.5.58	Polegate (Sussex) 20m. E.
E14537	f.g.	8.10.57	St. Agnes: 49°53'N. 6°21'W., Scilly (Cornwall) SABO
	×	22.3.58	Goldsithney (Cornwall) 44m. ENE.

Coal Tit (*Parus ater*) (I2: 5 miles)

A98081	ad.	27.8.57	Haywards Heath: 51°01'N. 0°06'W. (Sussex) PC
	×	11.11.57	Burton Latimer (Northamptonshire) 93m. NNW.

Wren (*Troglodytes troglodytes*) (I2: 10 miles)

C90555	f.g.	6.8.57	Halleaths: 55°08'N. 3°25'W., nr. Lockerbie (Dumfriesshire)
	×	12.10.57	RTS Malpas (Cheshire) 140m. SSE.

This is the longest movement so far recorded by the scheme for this species.

**Dipper** (*Cinclus cinclus*) (2: 2 miles)

- 0909 f.g. 17.9.56 Bywell: 54°57'N. 1°56'W., nr. Stocksfield (Northumberland) ND&N  
 × 3.3.57 Woolsington, nr. Ponteland (Northumberland) 12m. ENE.

**Mistle Thrush** (*Turdus viscivorus*) (23: 10 miles)

- 0111 O pull. 3.5.57 Littlestone: 50°59'N. 0°58'E. (Kent) DBO  
 + 13.11.57 Touvérac: 45°23'N. 0°13'W. (Charente) France

**Song Thrush** (*Turdus philomelos*) (190: 50 miles)

- 0423 ad. 10.9.55 Isle of May: 56°11'N. 2°33'W. (Fife)  
 () (10.12.57) Inverin, nr. Spiddal (Galway) 340m. SW.  
 0473 f.g. 10.3.56 Isle of May  
 × 8.9.57 Sandholme, nr. Howden (Yorkshire) 180m. SE.  
 04294 O pull. 5.5.57 Langwathby: 54°42'N. 2°39'W. (Cumberland) WH  
 () (20.11.57) Templeglantine (Limerick) 305m. WSW.  
 0539 ad. 20.1.57 Knock: 54°36'N. 5°52'W., Belfast (Down) GTF  
 × 9.5.57 Langbank (Renfrewshire) 103m. NE.  
 0668 O pull. 12.6.57 Ilkley: 53°56'N. 1°49'W. (Yorkshire) WNS  
 × 23.11.57 Port St. Mary, Isle of Man. 115m. W.  
 0709 ad. 11.9.55 Nr. Runcorn: 53°21'N. 2°44'W. (Cheshire) RPC  
 × (5.3.57) Ballyfin, Mountrath (Leix) 195m. W.  
 0997 1stW. 15.10.56 Bardsey: 52°46'N. 4°48'W. (Caernarvonshire)  
 × 23.5.57 Nr. Ilkley (Yorkshire) 140m. NE.  
 0053 f.g. 24.2.55 Blennerville: 52°16'N. 9°44'W., Tralee (Kerry) RGW  
 × (10.5.57) Lowick (Northumberland) 400m. NE.  
 0392 ad. 21.2.56 Skokholm: 51°42'N. 5°16'W. (Pembrokeshire)  
 × 9.6.57 Rotherfield Greys (Oxfordshire) 180m. E.  
 0053 f.g. 12.2.56 Havering: 51°38'N. 0°12'E., nr. Romford (Essex) HEW  
 × 13.7.57 Eastmoor, nr. Stoke Ferry (Norfolk) 67m. NNE.

**Redwing** (*Turdus musicus*) (4)

- 06586 1stW. 7.10.56 Fair Isle: 59°32'N. 1°37'W. (Shetland)  
 + (2.12.57) Alameda: 37°12'N. 4°39'W. (Malagá) Spain  
 06595 1stW. 9.10.56 Fair Isle  
 × 13.3.57 Nr. Ballymena (Antrim) 370m. SSW.  
 0037 1stW. 23.10.56 Fair Isle  
 [?/] 28.11.57 Nr. Charleville: 49°46'N. 4°43'E. (Ardennes) France  
 00294 1stW. 25.10.56 Fair Isle  
 × (22.4.57) Glenkindie, Alford (Aberdeenshire) 170m. SSW.  
 088686 and X89037 were identified as belonging to the race *T. m. musicus* ;  
 06094 to the race *T. m. coburni*.

**Ring Ouzel** (*Turdus torquatus*) (3: 5 miles)

- 0707 O pull. 19.5.57 Nr. Ilkley: 53°56'N. 1°49'W. (Yorkshire) ESS  
 + 20.10.57 Vergara: 43°07'N. 2°25'W. (Guipúzcoa) Spain

**Blackbird** (*Turdus merula*) (477)

Thirty-nine Blackbirds ringed in Great Britain and recovered in Ireland, or the Continent, are summarized in Table F.

Those records published in full include the most northerly recovery so far recorded for this species, southerly records, an interesting example of return migration, and all long distance movements of birds of presumed British origin.

TABLE F—COUNTRY AND MONTH OF RECOVERY OF BLACKBIRDS (*Turdus merula*)

Country of recovery	Oct.	Nov.	Dec.	Jan.	Feb.	Mar.	Apr.	May	June	July	Aug.	Sept.	Total
Norway ...		1		1		6	3	1		1			13
Sweden ...						4	1		1	2			8
Denmark ...											1		1
Germany ...						1	1		1				3
Holland (1) & Belgium (2)				1			2						3
France ...	1												1
Spain ...					1								1
Ireland <sup>1</sup> ...		2	3	1	1	1		(1)					9

See footnote to Table A.

X66146	1stW. ♂	2.11.55	Isle of May: 56°11'N. 2°33'W. (Fife)	
×		14.4.57	Nr. Bodö: 67°18'N. 14°26'E. (Nordland) <b>Norway</b>	
S41435	f.g. ♂	19.6.57	Duddingston Loch: 55°56'N. 3°09'W. (Midlothian) DRA	
×		8.11.57	Nr. Carrickfergus (Antrim) 130m. SW.	
S42689	1stW. ♂	22.8.56	Bamburgh: 55°36'N. 1°42'W. (Northumberland) MHBO	
×		24.1.57	Nr. Bangor (Down) 170m. WSW.	
S42905	1stW.	29.8.56	Bamburgh MHBO	
v		24.12.57	Tuam (Galway) 320m. WSW.	
W34313	O pull.	13.5.57	Langwathby: 54°42'N. 2°39'W. (Cumberland) WH	
×		16.12.57	Nr. Dungannon (Tyrone) 160m. W.	
S76947	ad. ♀	31.3.57	Copeland: 54°40'N. 5°32'W. (Down)	
v		15.4.57	Heligoland: 54°11'N. 7°55'E., <b>Germany</b>	
W26321	juv.	28.7.56	Everingham: 53°53'N. 0°46'W. (Yorkshire) JWL	
/?/		(27.11.57)	Gormanstown (Meath) 220m. W.	
288092	f.g. ♂	3.3.56	Skokholm: 51°42'N. 5°16'W. (Pembrokeshire)	
×		13.5.57	Anstey, nr. Leicester 180m. ENE.	
S58374	1stW. ♀	16.10.56	Dungeness: 50°51'N. 0°59'E. (Kent)	
/?/		2.2.57	Lequeitio: 43°21'N. 2°30'E. (Vizcaya) <b>Spain</b>	
S80821	juv.	22.6.57	Eastbourne: 50°46'N. 0°17'E. (Sussex) J&AP	
/?/		23.10.57	Hendaye: 43°22'N. 1°46'W. (Basses-Pyrénées) <b>France</b>	

**Wheatear (*Oenanthe oenanthe*) (5: 5 miles)**

C66842	1stW. ♂	10.9.57	Fair Isle: 59°32'N. 1°37'W. (Shetland)	
+		21.10.57	Sanlucar de Barameda: 36°46'N. 6°21'W. (Cádiz) <b>Spain</b>	
C16398	f.g.	7.9.56	Spurn Point: 53°35'N. 0°06'E. (Yorkshire)	
/?/		8.9.57	Zaragoza: 41°39'N. 0°54'W., <b>Spain</b>	
A54279	f.g.	18.8.55	Dungeness: 50°55'N. 0°59'E. (Kent)	
+		1.4.57	Ubeda: 38°01'N. 3°22'W. (Jaen) <b>Spain</b>	
C27656	ad. ♀	21.8.56	Dungeness	
+		0.10.56	le Haillan: 44°52'N. 0°41'W. (Gironde) <b>France</b>	



**Stonechat** (*Saxicola torquata*) (2)

- 105 f.g. 8.9.55 Dungeness: 50°55'N. 0°59'E. (Kent)  
 × 8.2.56 Porto Cristo: 39°32'N. 3°20'E., nr. Manacor, Majorca  
 This bird was found dead during very cold weather.

- 775 f.g. ♂ 12.10.57 Dungeness  
 + 19.11.57 Aigues Mortes: 43°34'N. 4°11'E. (Gard) France

**Redstart** (*Phoenicurus phoenicurus*) (6: 5 miles)

- 886 f.g. ♀ 21.9.57 Isle of May: 56°11'N. 2°33'W. (Fife)  
 + ca.10.11.57 Alcalá de los Gazules: 36°29'N. 5°43'W. (Cádiz) Spain  
 554 O pull. 19.6.57 Alnwick: 55°24'N. 1°42'W. (Northumberland) MHBO  
 + (30.9.57) Cervera del Rio Alhama: 42°00'N. 1°58'W. (Logroño)  
 Spain  
 551 O pull. 1.6.57 Thurstaston: 53°21'N. 3°09'W. (Cheshire) JCG  
 () (3.9.57) Nr. Villeneuve de Marson: 43°54'N. 0°18'W. (Landes)  
 France  
 334 f.g. ♂ 29.4.57 Portland Bill: 50°31'N. 2°27'W. (Dorset)  
 × (2.5.57) Barton, nr. Torquay (Devon) 45m. W.  
 446 ad. ♂ 14.10.57 St. Agnes: 49°53'N. 6°21'W., Scilly (Cornwall) SABO  
 × 25.10.57 Boscastle (Cornwall) 95m. ENE.

**Black Redstart** (*Phoenicurus ochruros*) (1)

- 773 ad. ♀ 16.10.56 Dungeness: 50°55'N. 0°59'E. (Kent)  
 × (29.1.57) Entroncamento: 39°27'N. 8°27'W. (Ribatejo) Portugal

**Robin** (*Erithacus rubecula*) (126: 15 miles)

- 440 f.g. 9.10.56 Spurn Point: 53°35'N. 0°06'E. (Yorkshire)  
 × (20.2.57) Wickersley, nr. Rotherham (Yorkshire) 52m. W.  
 110 f.g. 22.4.56 Bradwell-on-Sea: 51°44'N. 0°54'E. (Essex) BrBO  
 × 5.4.57 Uddebo: ca.57°29'N. 13°18'E., Tranemo (Älvsborg) Sweden  
 994 f.g. 15.10.56 Sandwich Bay: 51°17'N. 1°20'E. (Kent) SBRS  
 v 13.10.57 Bradwell-on-Sea (Essex) 35m. NW.  
 76210 is the first recovery of this species in Sweden. C59594 was identified  
 belonging to the Continental race *E. r. rubecula*.

**Reed Warbler** (*Acrocephalus scirpaceus*) (2: 5 miles)

- 440 ad. 4.5.56 Dungeness: 50°55'N. 0°59'E. (Kent)  
 × 7.6.57 Nr. Gravesend (Kent) 43m. NW.

**Sedge Warbler** (*Acrocephalus schoenobaenus*) (4: 5 miles)

- 214 O pull. 9.6.56 Cley: 52°58'N. 1°03'E. (Norfolk)  
 × (9.9.57) Cromer (Norfolk) 11m. ESE.  
 773 ad. 28.4.57 Skokholm: 51°42'N. 5°16'W. (Pembrokeshire)  
 v 29.4.57 Tuskar Rock: (Wexford) 53m. NW.  
 85 ad. 2.5.57 Dungeness: 50°55'N. 0°59'E. (Kent)  
 × 2.6.57 Nr. Littleport (Cambridgeshire) 109m. NNW.

**Blackcap** (*Sylvia atricapilla*) (2)

- 998 ad. ♀ 21.9.56 Gibraltar Point: 53°06'N. 0°21'E. (Lincolnshire)  
 v 30.4.57 Portland Bill (Dorset) 215m. SW.  
 078 ad. ♀ 8.5.57 Dungeness: 50°55'N. 0°59'E. (Kent)  
 × 24.6.57 Englefield, nr. Reading (Berkshire) 94m. WNW.

**Whitethroat** (*Sylvia communis*) (25: 30 miles)

One recovery in Portugal, classed as "probable," has been omitted.

E45353	juv.	3.9.57	Bamburgh: 55°36'N. 1°42'W. (Northumberland) MHBC
	/?/	19.9.57	Clavette: 46°09'N. 1°01'W., nr. La Rochelle (Charente-Maritime) <b>France</b>
A76929	juv.	21.8.57	Gibraltar Point: 53°06'N. 0°21'E. (Lincolnshire)
	/?/	ca. 12.9.57	Astrabudna: 43°19'N. 2°59'W., nr. Bilbao (Vizcaya) <b>Spain</b>
A35613	f.g.	21.8.55	Bardsey: 52°46'N. 4°48'W. (Caernarvonshire)
	+	22.9.57	Nr. Murça: 41°24'N. 7°28'W. (Tras-os-Montes) <b>Portugal</b>
C49316	f.g.	10.9.56	Bardsey
	+	29.9.57	Macieira de Cambra: 40°51'N. 8°24'W. (Beira Litoral) <b>Portugal</b>
C50519	ad.	3.5.57	Walberswick: 52°18'N. 1°41'E. (Suffolk) DBC
	×	(8.7.57)	Little Coggeshall (Essex) 50m. SW.
C50781	f.g.	1.8.57	Walberswick DBC
	×	22.8.57	Smarves: 46°31'N. 0°20'E., nr. Poitiers (Vienne) <b>France</b>
C54957	f.g. ♀	3.5.57	Great Saltee: 52°07'N. 6°35'W. (Wexford)
	×	3.8.57	Nr. Ardee (Louth) 120m. N.
A13284	f.g.	8.5.55	Sandwich Bay: 51°17'N. 1°20'E. (Kent) SBRS
	+	9.5.57	Cristo-Roquetas: 40°50'N. 0°30'E. (Tarragona) <b>Spain</b>
C68295	f.g.	4.5.57	Dungeness: 50°55'N. 0°59'E. (Kent)
	×	12.5.57	Spixworth, nr. Norwich (Norfolk) 120m. N.
C68296	ad. ♀	4.5.57	Dungeness
	×	9.6.57	New Haw, nr. Weybridge (Surrey) 68m. WNW.
C68858	ad. ♂	5.5.57	Dungeness
	×	29.10.57	Nr. Barranco do Velho: 37°14'N. 7°56'W. (Algarve) <b>Portugal</b>
C68932	f.g. ♂	5.5.57	Dungeness
	+	17.9.57	Braganca: 41°47'N. 6°46'W. (Tras-os-Montes) <b>Portugal</b>
C68971	f.g. ♀	5.5.57	Dungeness
	+	(19.9.57)	Oeiras: 38°41'N. 9°18'W. (Estremadura) <b>Portugal</b>
E26887	juv.	7.8.57	Dungeness
	×	13.8.57	Nr. Auneau: 48°27'N. 1°46'E. (Eure-et-Loire) <b>France</b>
E26344	juv.	18.8.57	Dungeness
	×	ca. 23.8.57	Margate (Kent) 36m. NNE.
C97923	f.g.	17.4.57	St. Catherine's Point: 50°34'N. 1°18'W., Isle of Wight (Hampshire) CJH
	×	15.5.57	Nr. Blidworth (Nottinghamshire) 170m. N.
B96710	1st W.	5.9.54	Portland Bill: 50°31'N. 2°27'W. (Dorset)
	×	(17.8.57)	Millmece, nr. Eccleshall (Staffordshire) 160m. N.
C91985	f.g. ♀	5.5.57	Portland Bill
	+	ca. 20.9.57	Murça: 41°24'N. 7°28'W. (Tras-os-Montes) <b>Portugal</b>

**Lesser Whitethroat** (*Sylvia curruca*) (3: 5 miles)

A76972	f.g.	27.8.57	Gibraltar Point: 53°06'N. 0°21'E. (Lincolnshire)
	+	28.9.57	Nr. Belluno: 46°08'N. 12°13'E. (Venezia) <b>Italy</b>

This record is in accordance with the south-easterly trend noted in other recoveries of this species.

**Willow Warbler** (*Phylloscopus trochilus*) (7: 25 miles)

020	juv.	10.8.57	Fenwick: 55°39'N. 1°54'W. (Northumberland)	ND&N
×		10.9.57	Ryton-on-Tyne (Co. Durham) 46m. S.	
559	f.g.	9.8.56	Bardsey 52°46'N. 4°48'W. (Caernarvonshire)	
×		23.4.57	Stradone (Cavan) 130m. NW.	
65	f.g.	11.8.56	Nr. West Wycombe: 51°39'N. 0°45'W. (Buckinghamshire)	
			JNK	
v		2.5.57	Portland Bill (Dorset) 110m. SW.	
89	f.g.	29.4.57	Portland Bill: 50°31'N. 2°27'W. (Dorset)	
×		2.5.57	Goffs Oak, nr. Cheshunt (Hertfordshire) 130m. NE.	

**Chiffchaff** (*Phylloscopus collybita*) (2)

008	ad.	16.4.57	Dungeness: 50°55'N. 0°59'E. (Kent)	
×		23.6.57	Oxton, Birkenhead (Cheshire) 240m. NW.	
88	juv.	27.9.57	Dungeness	
×		ca.6.11.57	Loures: 38°50'N. 9°10'W., nr. Lisbon (Estremadura)	Portugal

**Spotted Flycatcher** (*Muscicapa striata*) (5: 10 miles)

005	O	pull.	27.7.57	Knaresborough: 54°01'N. 1°28'W. (Yorkshire)	Sa&W
			2.10.57	Pedro Abad: 37°58'N. 4°27'W. (Cordoba)	Spain
259	O	pull.	3.7.55	Oxford: 51°45'N. 1°15'W.	EGI.
×			1.6.57	Holt, nr. Trowbridge (Wiltshire) 47m. SW.	
136	ad.		25.5.57	Skokholm: 51°42'N. 5°16'W. (Pembrokeshire)	
()			31.5.57	At sea, Biscay area: ca.46°25'N. 8°40'W. ca.400m. SSW.	

**Meadow Pipit** (*Anthus pratensis*) (12: 20 miles)

82	juv.	17.7.57	Fair Isle: 59°32'N. 1°37'W. (Shetland)	
×		5.10.57	Vila Nogueira de Azeitão: 38°31'N. 9°01'W. (Estremadura)	Portugal
217	f.g.	24.8.57	Fair Isle	
/?/		17.10.57	Le Boucau: 43°32'N. 1°29'W., nr. Bayonne (Basses-Pyrénées)	France
883	f.g.	16.9.57	Fair Isle	
+		16.10.57	Ludon-Medoc: 44°59'N. 0°36'W. (Gironde)	France
563	juv.	23.7.54	Nr. Seahouses: 55°35'N. 1°39'W. (Northumberland)	MHBO
/?/		11.1.57	Nr. Bouknadel: 34°11'N. 0°43'W., Rabat, Morocco	
248	f.g.	1.7.57	Spurn Point: 53°35'N. 0°06'E. (Yorkshire)	
/?/		2.9.57	Elgoibar: 43°12'N. 2°24'W. (Guipúzcoa)	Spain
177	ad.	9.10.56	Great Saltee: 52°07'N. 6°35'W. (Wexford)	
/?/		9.1.57	Elgueta: 43°09'N. 2°30'W. (Guipúzcoa)	Spain
820	f.g.	24.9.57	Abberton: 51°50'N. 0°53'E. (Essex)	
×		12.11.57	Estoril: 38°42'N. 9°23'W. (Estremadura)	Portugal
130	f.g.	11.10.56	Skokholm: 51°42'N. 5°16'W. (Pembrokeshire)	
/?/		10.1.57	Torrelavega: 43°21'N. 4°03'W. (Santander)	Spain

**Tree Pipit** (*Anthus trivialis*) (1)

227	1stW.	23.8.56	Skokholm: 51°42'N. 5°16'E. (Pembrokeshire)	
+		ca.25.9.57	Nr. Cantanhede: 40°20'N. 8°36'W. (Beira Litoral)	Portugal

**Rock Pipit** (*Anthus spinoletta*) (3: 5 miles)

962	1stW.	19.9.56	Beadnell: 55°33'N. 1°37'W. (Northumberland)	MHBO
v		12.1.57	Burnmouth (Berwickshire) 25m. NW.	

**Pied/White Wagtail (*Motacilla alba*) (29: 25 miles)**

A11687	f.g. ♀	3.6.56	Isle of May: 56°11'N. 2°33'W. (Fife)
×		3.2.57	East Denton, Newcastle-on-Tyne 88m. SE.
A67330	juv.	2.9.55	Abberton: 51°50'N. 0°53'E. (Essex)
+		1.1.57	Nr. Montemor-o-Novo: 38°38'N. 8°13'W. (Alto Alentejo Portugal)
A82505	juv.	9.7.56	Abberton
×		(27.7.57)	Mersham, nr. Ashford (Kent) 47m. S.
C46329	juv.	23.9.56	Abberton
v		16.12.57	Cambridge 39m. NW.
E51236	juv.	19.8.57	Abberton
+	ca.	21.10.57	Nr. Pombal: 39°55'N. 8°38'W. (Beira Litoral) Portugal
A21879	O pull.	16.7.55	Romford: 51°35'N. 0°11'E. (Essex) RRS
×		(6.7.57)	Eaton Bray (Bedfordshire) 40m. NW.
C81533	juv.	1.9.57	Romford RRS
×		28.10.57	Nr. Vila Real de Santo António: 37°12'N. 7°25'W. (Algarve) Portugal

**Grey Wagtail (*Motacilla cinerea*) (1)**

C36306	O pull.	8.7.56	Warcop: 54°32'N. 2°24'W. (Westmorland) RWR
×		18.2.57	Hanley, Stoke-on-Trent (Staffordshire) 102m. S.

**Yellow Wagtail ssp. (*Motacilla flava*) (10: 25 miles)**

B17552	juv.	28.7.54	Nr. Halifax: 53°43'N. 1°51'W. (Yorkshire) HSS
×		30.9.57	Murtosa: 40°45'N. 8°39'W. (Beira Litoral) Portugal
E41373	juv.	22.7.57	East Tilbury: 51°28'N. 0°26'E. (Essex) ABO
()		(27.9.57)	Fundão: 40°08'N. 7°30'W. (Beira Baixa) Portugal

**Starling (*Sturnus vulgaris*) (967)**

A total of 125 Starlings were recovered abroad as given in Table G.

TABLE G—COUNTRY AND MONTH OF RECOVERY OF STARLINGS (*Sturnus vulgaris*)

Country of recovery	Mar.	Apr.	May	June	July	Aug.	Sept.	Oct.	Nov.	Dec.	Jan.	Feb.
France (2) ...	...		1								(1)	
Belgium (7) ...	...						(1)	3	2			1
Holland (13) ...	...	2	3	3	1	1	1	1				1
Denmark (10) ...	...		2	1		3	3		1			
Norway (11) & Sweden (1) ...	...	2	2	2	1	1	3			1		
Germany (23) & Switzerland (1) ...	...	6	3	4	1	4	4	2				
Poland (19) ...	...	8	5	2	1	3						
Finland (2) & Baltic States (18*) ...	...	8	2	3	1	2	2			1		
U.S.S.R. (18) ...	...	7	4	3	1	3						

\*Includes a bird marked "spring".  
See footnote to Table A.

The months of ringing of the birds of presumed Continental origin were:—October, 4; November, 14; December, 18; January, 18; February, 46; March, 22; and April, 1. The extreme dates were 16th October and 2nd April.

Mild weather in the early part of the year was probably responsible for the unusually early return of some Starlings to their eastern breeding grounds, but, however, many experienced the severe weather which occurred in late-March.

The following records, arranged in date order of recovery, illustrate this early return:—

Ringed			Recovered				
..	..	12.12.55	7.3.57	Poland	..	..	53°49'N. 22°22'E.
ect	..	19.2.56	9.3.57	Lithuania	..	..	55°15'N. 22°20'E.
..	..	3.11.54	15.3.57	U.S.S.R.	..	..	54°20'N. 21°07'E.
estershire	..	9.3.55	16.3.57	Poland	..	..	54°10'N. 19°24'E.
colnshire	..	1.2.56	16.3.57	Estonia	..	..	58°23'N. 24°30'E.
humberland	..	31.10.53	mid-3.57	Latvia	..	..	56°32'N. 21°01'E.
..	..	3.11.54	17.3.57	U.S.S.R.	..	..	54°00'N. 29°23'E.
wickshire	..	19.3.56	17.3.57	Estonia	..	..	58°54'N. 23°33'E.
shire	..	22.2.56	18.3.57	Latvia	..	..	56°32'N. 21°00'E.
..	..	10.3.56	18.3.57	Poland	..	..	54°13'N. 21°45'E.
xx	..	13.3.55	18.3.57	Poland	..	..	53°46'N. 20°29'E.
xxshire	..	1.2.56	18.3.57	Poland	..	..	53°26'N. 21°08'E.
folk	..	16.11.55	19.3.57	Estonia	..	..	58°44'N. 26°28'E.
xx	..	4.12.55	19.3.57	Latvia	..	..	56°00'N. 26°19'E.
folk	..	2.1.56	20.3.57	Poland	..	..	53°02'N. 23°37'E.
tt	..	14.1.55	20.3.57	U.S.S.R.	..	..	51°56'N. 30°47'E.
ffordshire	..	5.2.57	21.3.57	Poland	..	..	54°12'N. 22°55'E.
tt	..	20.1.55	21.3.57	U.S.S.R.	..	..	55°10'N. 30°15'E.

Despite the large number of recoveries, there was little indication of long-distance movement within the British Isles—as is shown in the following summary:—

Number of recoveries	Distance in miles				
	0-50	51-100	101-150	151-200	201-250
..	806	25	6	3	2

Of the 36 movements of over 50 miles only 13 were made by birds of British probable British origin. However, two birds ringed as juveniles, and of probable British stock, were recovered abroad. The record of the bird in Switzerland is the first of its kind, but has been fully substantiated. It is the first British recovery of any species in Switzerland.

The recovery locality of the third bird listed in detail below, Pertominsk, is on the shores of the White Sea, and this is one of the most distant Starling recoveries so far recorded.

0741	juv.	7.8.55	Northampton: 52°14'N. 0°54'W. BRS
v		1.4.56	ibid
x		14.9.57	Ennetbach: 47°16'N. 8°57'E., nr. Goldingen (St. Gallen) <b>Switzerland</b>
144	juv.	23.6.57	Romford: 51°35'N. 0°11'E. (Essex) RRS
()		2.10.57	le Zwin: 51°21'N. 3°21'E., nr. Knokke (West Flanders) <b>Belgium</b>
019	f.g.	15.1.55	Chilton: 51°34'N. 1°17'W. (Berkshire) OOS
+		23.4.57	Nr. Pertominsk: 64°43'N. 38°28'E. (Arkhangel) <b>U.S.S.R.</b>

**Greenfinch** (*Chloris chloris*) (120: 30 miles)

S42015	1stW. ♂	23.1.56	Nr. Seahouses: 55°35'N. 1°39'W. (Northumberland)
	×	(15.7.57)	MHBO Pelton, nr. Chester-le-Street (Co. Durham) 48m. S
X83062	f.g. ♀	11.3.54	Abberton: 51°50'N. 0°53'E. (Essex)
	×	3.5.57	Longfield, Dartford (Kent) 35m. SW.
W37619	f.g. ♂	24.10.55	Dungeness: 50°55'N. 0°53'E. (Kent)
	×	ca.1.5.57	Hove (Sussex) 49m. W.
S36206	ad.	2.3.56	Iwerne Minster: 50°56'N. 2°11'W. (Dorset) CS
	×	(30.12.57)	Tudeley, nr. Tonbridge (Kent) 107m. ENE.
SI2487	ad. ♂	2.2.56	Shoreham: 50°50'N. 0°16'W. (Sussex) JS
	×	8.8.57	Elham, nr. Folkestone (Kent) 63m. ENE.

**Goldfinch** (*Carduelis carduelis*) (3: 5 miles)

E49570	juv.	25.8.57	Beddington: 51°23'N. 0°08'W., Croydon (Surrey) LNHS
	()	mid-10.57	Obourg: 50°28'N. 4°01'E., nr. Mons (Hainaut) <b>Belgium</b>
E46591	1stW.	9.10.57	Dungeness: 50°55'N. 0°59'E. (Kent)
	v	25.10.57	Armentières: 50°41'N. 2°53'E. (Nord) <b>France</b>

**Linnet** (*Carduelis cannabina*) (17: 10 miles)

B70021	f.g. ♂	27.4.55	Spurn Point: 53°35'N. 0°06'E. (Yorkshire)
	×	ca.4.12.57	Nr. Biarritz: 43°29'N. 1°33'W. (Basses-Pyrénées) <b>France</b>
C75495	O pull.	4.5.57	Cambridge: 52°12'N. 0°07'E. CDTM
	×	12.10.57	Bruges: 44°53'N. 0°32'W., nr. Bordeaux (Gironde) <b>France</b>
C27732	juv.	21.8.56	Dungeness: 50°55'N. 0°59'E. (Kent)
	×	20.8.57	Wrentham, nr. Beccles (Suffolk) 103m. NNE.
C60452	1stW. ♂	6.10.56	Dungeness
	+	14.3.57	Souprosse: 43°47'N. 0°42'W. (Landes) <b>France</b>

**Redpoll** (*Carduelis flammea*) (3)

E49835	1stW. ♂	28.9.57	Beddington: 51°23'N. 0°08'W., Croydon (Surrey) LNHS
	v	10.12.57	Wanfercée-Baulet: 50°28'N. 4°35'E., nr. Charleroi (Hainaut) <b>Belgium</b>
E46621	ad. ♀	10.10.57	Dungeness: 50°55'N. 0°59'E. (Kent)
	()	1.11.57	Seraing: 50°37'N. 5°31'E. (Liège) <b>Belgium</b>
27594	f.g.	10.11.57	Dungeness
	v	15.11.57	Armentières: 50°41'N. 2°53'E. (Nord) <b>France</b>

**Chaffinch** (*Fringilla coelebs*) (48: 20 miles)

C23806	ad. ♀	24.9.56	Ilkley: 53°56'N. 1°49'W. (Yorkshire) WNS
	×	7.2.57	Claremorris (Mayo) 290m. W.
CI6513	f.g. ♂	30.3.56	Spurn Point: 53°35'N. 0°06'E. (Yorkshire)
	v	25.10.57	North Sea: ca.52°20'N. 3°10'E.
B93524	ad. ♀	21.10.54	Bardsey: 52°46'N. 4°48'W. (Caernarvonshire)
	×	1.5.57	Orleton, nr. Stanford Bridge (Worcestershire) 100m. ESE.
B90594	juv.	20.8.54	Leicester: 52°38'N. 1°05'W. L&R
	v	28.3.57	Nottingham 22m. N.
B23390	ad. ♂	25.10.53	Great Saltee: 52°07'N. 6°35'W. (Wexford)
	×	(30.9.57)	Nr. Ikast: 56°09'N. 9°10'E. (Jutland) <b>Denmark</b>

46	1st W. ♀	8.11.56	Great Saltee
×		ca. 11.7.57	Ullern: 60°13'N. 11°40'E., nr. Skarnes (Hedmark) Norway
75	juv.	23.8.54	Chelmsford: 51°44'N. 0°29'E. (Essex) P&B
v		mid-3.57	Little Clacton (Essex) 28m. ENE.
80	ad. ♂	12.2.55	Nr. Brentwood: 51°38'N. 0°17'E. (Essex) ACP
×		14.11.57	Hoevenen: 51°18'N. 4°24'E. (Antwerp) Belgium
546	f.g. ♀	5.2.56	Romford: 51°35'N. 0°11'E. (Essex) HE&W
/?/		10.6.57	Ransverk: 61°43'N. 9°03'E., nr. Vågå (Opland) Norway
313	ad. ♂	20.3.55	Chessington: 51°21'N. 0°18'W. (Surrey) DP
×		14.9.55	Norheimsund: 60°22'N. 6°09'E. (Hordaland) Norway
76	f.g. ♀	17.2.57	Wembdon: 51°08'N. 3°01'W., nr. Bridgwater (Somerset) EMP
v		15.10.57	Courtrai: 50°50'N. 3°17'E. (West Flanders) Belgium
961	ad. ♂	28.2.55	Liss: 51°03'N. 0°54'W. (Hampshire) RL
()		ca. 1.11.57	Belsele: 51°09'N. 4°05'E., nr. St. Niklaas (East Flanders) Belgium

### Brambling (*Fringilla montifringilla*) (1)

12	f.g. ♀	15.10.56	Isle of May: 56°11'N. 2°33'W. (Fife)
v		22.10.57	Brecht: 51°21'N. 4°38'E. (Antwerp) Belgium

## BRITISH RECOVERIES OF BIRDS RINGED ABROAD

Communicated by E. P. LEACH

THIS LIST continues from that published earlier this year (*antea*, pp. 57-72) and follows previous practice in that it omits certain species and is selective in the case of others. Foreign-ringed Black-headed Gulls (*Larus ridibundus*) and Common Gulls (*L. canus*) occur each winter in considerable numbers, but the pattern of recoveries remains unchanged. The same applies to Pink-footed Geese (*Anser arvensis brachyrhynchus*): those ringed on the breeding-grounds in central Iceland by the Wildfowl Trust expeditions in 1951 and 1953 are still recovered in fair numbers, but, of course, there are fewer as the years go by. The records of Starlings (*Sturnus vulgaris*), Mallard (*Anas platyrhynchos*) and Teal (*Anas crecca*) are given only where the recovery details show definitely the countries of origin: by far the greater proportion of each of these three species is ringed on passage.

## Selected List of Recoveries Reported

The symbols and terms are the same as those used in the "Report on bird-ringing" (see page 459), with the exception that the term "juv." cannot always be relied upon to signify a young bird that is able to fly freely: owing to lack of unanimity in the various ringing schemes, this term may sometimes mean a nestling or chick.

### *Abbreviations used for Ringing Stations*

B.	Brussels	P.	Paris
C.	Copenhagen	Pe.	Prague
H.	Heligoland	Rh.	Reykjavik
Hki.	Helsinki	Stav.	Stavanger
L.	Leiden	St. Orn.	Stockholm "Ornis" (Sverige Ornithologiska Förening)
M.	Moscow	S.J.F.	Svenska Jagare Förbundet
O.	Oslo		

[As has been our practice in the past, we should like to draw attention to some of the more significant records in the list that follows. Of special interest are the recoveries of Shelduck ringed for Heligoland Bird Observatory while in flightless moult on the Knechtsand in the Weser estuary. These have come from many different areas: on the east coast from Suffolk to the Firth of Tay and on the west from Morecambe Bay to Pembroke, with one on the English Channel coast and others as far as Waterford and Galway in Ireland. They thus confirm the wide scatter and large scale of the annual moult-migration from the British Isles to the Heligoland Bight area. Unfortunately the time elapsed between ringing and recovery is in most cases too great for detailed tracking of movement, but one September-ringed bird from the Weser was back in Morecambe Bay at least before the year's end.

An equally important feature is the growth of wader ringing and recoveries, showing movements of Golden Plover between Iceland or the Netherlands and Great Britain, of Snipe between Scandinavia and southern England, of Curlew from Finland, and of Turnstone, Knot and Dunlin. The Lapwing recoveries include a bird from Finland and two from Czechoslovakia, while one ringed in Norway was in its thirteenth year when killed in Ireland.

The heavy infiltration of young Great Black-backed Gulls from Norway is a factor to be taken into account in bird protection, and Herring Gulls are now also shown to come in from the north of that country on a significant scale. There are two East Coast records of White Sea Kittiwakes, and a Razorbill from north Russia is recorded from Cornwall. It is interesting to note the passage of an Iceland-bred Wheatear through Dungeness within about nine weeks of fledging and also the occurrence in Sussex of a Reed Bunting from the Netherlands, the first British recovery of a bird of this species ringed on the Continent.—EDS.]

### Heron (*Ardea cinerea*)

O.	O	pull.	13.6.55	Egersund: 58°28'N. 6°00'E. (Rogaland) <b>Norway</b>
036828	×		1.5.56	Salen: 56°30'N. 5°57'W. I. of Mull (Argyllshire)
O.	O	pull.	15.6.55	Egersund, <b>Norway</b>
036806	×		25.2.56	Mill Isle: 54°35'N. 5°35'W. (Down)
O.	O	pull.	15.6.55	Egersund, <b>Norway</b>
036813	×		6.3.56	Kirkmichael: 56°42'N. 3°28'W. (Perthshire)
P.	O	pull.	13.5.57	Clairmarais: 50°45'N. 2°15'E. (Pas-de-Calais) <b>France</b>
CD5091	×	(wires' ca. 24.11.57)		North Stoke: 51°35'N. 1°08'W. (Oxfordshire)
O.	O	pull.	10.6.42	Egersund, <b>Norway</b>
6404	×		0.8.56	Edderton: 57°49'N. 4°10'W. (Ross-shire)

The ring and leg-bones of the last Heron were found at the bottom of a river, so it cannot possibly be said at what date the bird actually died.



**Bittern** (*Botaurus stellaris*)

	O	pull.	23.4.57	Kalmthout: 51°23'N. 4°28'E. (Antwerp) <b>Belgium</b>
437	×	(long time)	2.10.57	Kenfig: 51°32'N. 3°44'W. (Glamorgan)

**Mallard** (*Anas platyrhynchos*)

	O	juv.	25.7.55	Pori: 61°30'N. 21°45'E. <b>Finland</b>
067	×		26.11.55	Marsh Gibbon: 51°54'N. 1°04'W. (Buckinghamshire)
	O	juv.	9.8.55	Kokkola: 63°50'N. 23°08'E. <b>Finland</b>
791	+		9.2.57	Dumbarton: 55°56'N. 4°34'W.
	O	pull.	4.7.57	Robertsfors: 64°11'N. 20°51'E. (Västerbotten) <b>Sweden</b>
550	+	♂	24.11.57	Holbeach Marsh: 52°52'N. 0°05'E. (Lincolnshire)
	O	pull.	11.6.55	Hamar: 60°48'N. 11°05'E. (Hedmark) <b>Norway</b>
106	+		22.2.56	Ingleby Greenhow: 54°26'N. 1°06'W. (Yorkshire)

**Teal** (*Anas crecca*)

	O	pull.	29.7.56	Arnanes: 66°08'N. 16°44'W. North <b>Iceland</b>
448	+		19.1.57	Bellshill: 55°49'N. 4°02'W. (Lanarkshire)
	O	pull.	2.8.57	Fnjóskadalur: 65°46'N. 17°53'W. <b>Iceland</b>
832	+		23.9.57	Eglintou: 55°02'N. 7°11'W. (Londonderry)
	O	pull.	2.8.57	Fnjóskadalur, <b>Iceland</b>
833	+		14.10.57	South Uist: Outer Hebrides
	O	pull.	6.7.55	Varhaug: 58°37'N. 5°41'E. (Rogaland) <b>Norway</b>
916	+		30.1.56	Lismore: 52°09'N. 7°56'W. (Waterford)
		juv.	25.8.57	Amager: 55°40'N. 12°38'E. <b>Denmark</b>
6500	+		14.12.57	Astley: 53°31'N. 2°27'W. (Lancashire)

**Gadwall** (*Anas strepera*)

	ad.		27.11.54	Giethoorn: 52°45'N. 6°05'E. (Overijssel) <b>Holland</b>
006	+		25.10.57	Newtown Butler: 54°11'N. 7°21'W. (Fermanagh)

**Wigeon** (*Anas penelope*)

	O.	pull.	7.7.50	Borgarfjordur: 64°38'N. 21°32'W. <b>Iceland</b>
0920	+		7.1.57	Ardmaddy Castle: 56°17'N. 5°34'W. (Argyllshire)
	O	ad. ♀	21.6.53	Skipalón: 65°47'N. 18°12'W. <b>Iceland</b>
002	v		21.8.56	ibid.
	+		22.12.57	Cobh (ex-Queenstown) 51°51'N. 8°17'W. (Cork)
	O	pull.	13.7.56	Arnanes: 66°08'N. 16°44'W. North <b>Iceland</b>
444	+	♀	26.12.57	Tregynon: 52°35'N. 3°20'W. (Montgomeryshire)
	O.	pull.	19.6.57	Myvatn: 65°39'N. 16°58'W. <b>Iceland</b>
0547	+		20.10.57	Spa: 52°17'N. 9°47'W. (Kerry)
	♂		13.8.39	Volga Delta: 46°14'N. 49°02'E. <b>U.S.S.R.</b>
242	/?/		11.1.40	Stranraer: 54°54'N. 5°02'W. (Wigtownshire)
	O	pull.	30.7.56	Skjold: 69°02'N. 19°18'E. (Troms) <b>Norway</b>
372	+		21.12.56	Meikleour: 56°33'N. 3°21'W. (Perthshire)
		juv. ♀	14.10.54	Texel: 53°06'N. 4°48'E. <b>Holland</b>
030	+		30.12.55	St. Athan: 51°24'N. 3°25'W. (Glamorgan)
		juv. ♀	18.10.54	Texel, <b>Holland</b>
032	+		19.2.55	Lough Mahon: 51°53'N. 8°22'W. (Cork)
	f.g.		1.11.54	Giethoorn: 52°45'N. 6°05'E. (Overijssel) <b>Holland</b>
518	+		22.9.55	Wrangle: 53°02'N. 0°08'E. (Lincolnshire)
	ad. ♂		7.1.55	Lekkerkerk: 51°55'N. 4°43'E. Zuid <b>Holland</b>
499	+		16.12.55	Knockainey: 52°28'N. 8°28'W. (Limerick)

**Pintail** (*Anas acuta*)

L.	juv.	28.11.57	Oudesluis: 52°50'N. 4°49'E. Noord <b>Holland</b>
346044	+	22.12.57	Blakeney: 52°58'N. 1°01'E. (Norfolk)

**Shoveler** (*Spatula clypeata*)

L.	♂	24.8.55	Lekkerkerk: 51°55'N. 4°43'E. Zuid <b>Holland</b>
269516	+	11.11.55	Stodmarsh: 51°18'N. 1°13'E. (Kent)
L.	juv. ♀	3.12.55	Oudesluis: 52°50'N. 4°49'E. Noord <b>Holland</b>
277071	+	25.12.55	Ballyteige: 52°11'N. 6°38'W. (Wexford)

**Goldeneye** (*Bucephala clangula*)

S.J.F.	○	pull.	25.7.49	Silkkimuotka: 68°03'N. 21°44'E. (Lappland) <b>Sweden</b>
8733	×		7.3.55	River Dee, Aberdeen: 57°08'N. 2°05'W.

**Red-breasted Merganser** (*Mergus serrator*)

Rk.	ad. ♀	10.7.35	Myvatn: 65°39'N. 16°58'W. <b>Iceland</b>
3/585	v	29.6.40	ibid.
3/1902	+	winter	'44/45 Kincasslagh: 55°02'N. 8°23'W. (Donegal)
Rk.	juv.	6.9.56	Myvatn, <b>Iceland</b>
33619	+	5.1.57	Grimersta: 58°11'N. 6°45'W. I. of Lewis, Outer Hebrides

**Shelduck** (*Tadorna tadorna*)

St. Orn.	juv.	8.8.55	Ottenby: 56°13'N. 16°25'E. Öland, <b>Sweden</b>
885003	×	5.2.56	Walton-on-the-Naze: 51°51'N. 1°18'E. (Essex)
B.	juv.	20.8.56	Le Zoute: 51°20'N. 3°17'E. (West Flanders) <b>Belgium</b>
2H3399	+	26.1.57	Instow: 51°04'N. 4°10'W. (Devonshire)
H.	ad.	10.8.52	Estuary of R. Weser: ca. 53°50'N. 8°20'E. <b>Germany</b>
358340	+	6.2.54	Pagham: 50°46'N. 0°43'W. (Sussex)
H.	ad.	17.8.52	Estuary of R. Weser, <b>Germany</b>
358385	×	13.1.55	Pembroke Dock: 51°42'N. 4°56'W.
H.	ad.	24.8.52	Estuary of R. Weser, <b>Germany</b>
358231	×	21.2.57	Breydon Water: ca. 52°37'N. 1°42'E. (Norfolk)
H.	ad.	24.8.52	Estuary of R. Weser, <b>Germany</b>
358234	×	26.1.55	Wootton Marshes: 52°48'N. 0°27'E. (Norfolk)
H.	ad.	24.8.52	Estuary of R. Weser, <b>Germany</b>
358263	+	1.2.54	Grangemouth: 56°01'N. 3°44'W. (Stirlingshire)
H.	ad.	31.8.52	Estuary of R. Weser, <b>Germany</b>
365710	(ring only)	10.2.56	Rhydd-ddu: 53°02'N. 4°09'W. (Caernarvonshire)
H.	ad.	31.8.52	Estuary of R. Weser, <b>Germany</b>
365801	+	8.1.54	Lettermore: 53°18'N. 9°40'W. (Galway)
H.	ad.	31.8.52	Estuary of R. Weser, <b>Germany</b>
365835	×	20.1.57	Seaton Carew: 54°40'N. 1°11'W. (Durham)
H.	ad.	31.8.52	Estuary of R. Weser, <b>Germany</b>
365838	×	15.2.56	Cockerham: 53°59'N. 2°50'W. (Lancashire)
H.	ad.	31.8.52	Estuary of R. Weser, <b>Germany</b>
365859	×	10.1.53	Orford: 52°06'N. 1°33'E. (Suffolk)
H.	ad.	31.8.52	Estuary of R. Weser, <b>Germany</b>
365863	×	(24.5.54)	Kinnaird: 56°26'N. 3°14'W. (Perthshire)

- ad. 16.7.54 Estuary of R. Weser, **Germany**  
 × 13.2.55 Shotton: 53°12'N. 3°02'W. (Flintshire)  
 ad. 12.8.55 Estuary of R. Weser, **Germany**  
 × 9.4.56 Villierstown: 52°06'N. 7°51'W. (Waterford)  
 ad. 4.9.55 Estuary of R. Weser, **Germany**  
 × 28.12.55 Askham-in-Furness: 54°12'N. 3°13'W. (Lancashire)
- the Shelduck carrying Heligoland rings were caught for ringing while  
 withoutless moult.

**Water Rail (*Rallus aquaticus*)**

- juv. 19.8.55 Zwartee Meer: 52°38'N. 6°00'E. (Overijssel) **Holland**  
 × 16.11.55 Enfield Lock: 51°41'N. 0°01'W. (Middlesex)

**Moorhen (*Gallinula chloropus*)**

- O pull. 19.7.51 Akkerwoude: 53°18'N. 6°00'E. (Friesland) **Holland**  
 × 4.12.55 R. Wye, Erwood: 52°06'N. 3°19'W. (Breconshire)

**Coot (*Fulica atra*)**

- ♂ 26.12.53 Ratzeburg: 53°43'N. 10°47'E. (Schleswig-Holstein) **Germany**  
 × 22.1.57 Treseo: 49°58'N. 6°20'W. Scilly Is.

**Lapwing (*Vanellus vanellus*)**

- O pull. 30.5.55 Espoo: 60°11'N. 24°50'E. **Finland**  
 × 5.9.57 Pilling: 53°56'N. 2°55'W. (Lancashire)  
 O pull. 15.5.43 Time: 58°43'N. 5°38'E. (Rogaland) **Norway**  
 + 6.2.56 West Newcastle: 52°27'N. 9°06'W. (Limerick)  
 O pull. 19.5.52 Time, **Norway**  
 × 19.1.56 Blyth: 55°10'N. 1°30'W. (Northumberland)  
 O pull. 4.6.53 Time, **Norway**  
 × 6.2.56 Poulton-le-Fylde: 53°50'N. 3°00'W. (Lancashire)  
 O pull. 1.6.52 Varhaug: 58°37'N. 5°41'E. (Rogaland) **Norway**  
 × 28.2.56 St. David's: 51°52'N. 5°18'W. (Pembrokeshire)  
 O pull. 22.5.55 Klepp: 58°48'N. 5°43'E. (Rogaland) **Norway**  
 11 /?/ 0.1.56 Abbeyfeale: 52°23'N. 9°18'W. (Limerick)  
 O pull. 21.5.56 Husum: 54°31'N. 9°02'E. (Schleswig-Holstein) **Germany**  
 29 × 0.12.57 Wellington: 52°42'N. 2°31'W. (Shropshire)  
 O pull. 12.5.56 Wilhelmshaven: 53°32'N. 8°08'E. **Germany**  
 35 × 12.2.57 Chichester: 50°50'N. 0°47'W. (Sussex)  
 O pull. 1.5.43 Lipa: 49°34'N. 15°34'E. **Czechoslovakia**  
 × 23.2.47 Portland: 50°31'N. 2°27'W. (Dorset)  
 O pull. 2.6.44 Olomouc: 49°32'N. 17°15'E. **Czechoslovakia**  
 × 1.2.47 Guernsey: 49°27'N. 2°36'W. Channel Is.

**Golden Plover (*Charadrius apricarius*)**

- O pull. 5.7.54 Myvatn: 65°39'N. 16°58'W. **Iceland**  
 + 28.11.57 Bodmin Moor: ca.50°34'N. 4°34'W. (Cornwall)  
 O pull. 7.7.54 Skipalon: 65°47'N. 18°12'W. **Iceland**  
 + 31.10.57 Ballina area: ca.54°07'N. 9°20'W. (Mayo)  
 f.g. 7.11.56 Hogebeintum: 53°20'N. 5°51'E. (Friesland) **Holland**  
 + 10.1.57 Romney Marsh: ca.51°00'N. 0°55'E. (Kent)  
 ad. 16.11.56 Werwershoof: 52°44'N. 5°09'E. Noord **Holland**  
 × 20.4.57 Isle of Tiree: 56°30'N. 6°50'W. (Argyllshire)

**Turnstone** (*Arenaria interpres*)

<i>Rk.</i>	ad.	26.5.57	Midnes: 64°04'N. 22°43'W. <b>Iceland</b>
611178	v	6.12.57	West Kirby: 53°22'N. 3°11'W. (Cheshire)
<i>Rk.</i>	ad.	22.8.57	Midnes, <b>Iceland</b>
710182	+	0.12.57	Inishark: 53°37'N. 10°18'W. (Galway)

**Snipe** (*Capella gallinago*)

<i>O.</i>	O	pull.	25.5.52	Heskestad: 58°28'N. 6°25'E. (Rogaland) <b>Norway</b>
059627	+		6.10.56	Stodmarsh: 51°18'N. 1°13'E. (Kent)
<i>C.</i>	f.g.	25.8.56	Copenhagen: 55°41'N. 12°35'E. <b>Denmark</b>	
701087	+	ca.12.1.57	Redruth: 50°13'N. 5°14'W. (Cornwall)	

**Woodcock** (*Scolopax rusticola*)

<i>Stav.</i>	O	pull.	29.5.55	Tjølling: 59°04'N. 10°10'E. (Vestfold) <b>Norway</b>
605204	+		23.12.55	Loughall: 54°25'N. 6°37'W. (Armagh)

**Curlew** (*Numenius arquata*)

<i>Hki.</i>	O	pull.	6.6.56	Pori: 61°31'N. 21°45'E. <b>Finland</b>
C53828	+		7.9.56	Mouth of R. Nene: 52°45'N. 0°14'E. (Lincolnshire)
<i>Hki.</i>	O	pull.	12.6.56	Oulujoki: 64°58'N. 25°27'E. <b>Finland</b>
C38600	+		5.10.56	Billingham: 54°36'N. 1°17'W. (Durham)
<i>Hki.</i>	O	pull.	15.6.56	Oulujoki, <b>Finland</b>
C51503	×		0.2.57	Fearn: 57°47'N. 3°52'W. (Ross-shire)
<i>Hki.</i>	O	pull.	5.7.56	Strömfors: 60°34'N. 26°30'E. <b>Finland</b>
C37750	+	ca.	15.10.56	Saltfleet Haven: 53°26'N. 0°11'E. (Lincolnshire)
<i>Stav.</i>	O	pull.	10.6.55	Sola: 58°53'N. 5°38'E. (Rogaland) <b>Norway</b>
52369	+		(5.12.56)	Tuam: 53°22'N. 8°51'W. (Galway)
<i>B.</i>	O	pull.	21.5.56	Turnhout: 51°19'N. 4°57'E. (Antwerp) <b>Belgium</b>
2G4099	+		20.1.57	Stow Maries: 51°39'N. 0°39'E. (Essex)

**Bar-tailed Godwit** (*Limosa lapponica*)

<i>Stav.</i>	f.g.	30.9.56	Revtangen: 58°45'N. 5°30'E. (Rogaland) <b>Norway</b>
613389	×	(23.10.56)	Lochmaddy: 57°37'N. 7°05'W. North Uist (Outer Hebrides)

**Redshank** (*Tringa totanus*)

<i>Rk.</i>	ad.	8.9.53	Midnes: 64°04'N. 22°43'W. <b>Iceland</b>
5/3670	+	0.1.57	Birr: 53°06'N. 7°54'W. (Offaly)
<i>Rk.</i>	ad.	17.5.57	Midnes, <b>Iceland</b>
78218	+	22.12.57	Craughwell: 53°14'N. 8°44'W. (Galway)

**Knot** (*Calidris canutus*)

<i>Rk.</i>	f.g.	13.5.51	Midnes: 64°04'N. 22°43'W. <b>Iceland</b>
7/2444	+	29.3.57	Flookburgh: 54°11'N. 2°59'W. (Lancashire)
<i>Rk.</i>	ad.	27.5.57	Midnes, <b>Iceland</b>
611222	+	16.11.57	Newtownards: 54°35'N. 5°41'W. (Down)
<i>Stav.</i>	f.g.	16.8.55	Revtangen: 58°45'N. 5°30'E. (Rogaland) <b>Norway</b>
725393	v	31.1.57	Flookburgh: (Lancashire)

The last Knot also carried a second Stavanger ring, viz.—738093.

**Dunlin** (*Calidris alpina*)

	f.g.	7.9.48	Revtangen: 58°45'N. 5°30'E. (Rogaland) <b>Norway</b>
+		4.12.55	Kinvara: 53°09'N. 8°55'W. (Galway)
	f.g.	12.9.51	Revtangen, <b>Norway</b>
×		12.1.56	Didsbury: 53°28'N. 2°15'W. (Lancashire)
	f.g.	31.8.53	Revtangen, <b>Norway</b>
+		18.2.57	Valley, 53°17'N. 4°34'W. Anglesey
	f.g.	9.9.56	Revtangen, <b>Norway</b>
×		(19.9.56)	Warrington: 53°27'N. 2°35'W. (Lancashire)
	f.g.	10.9.56	Revtangen, <b>Norway</b>
+		27.10.56	Coleraine: 55°20'N. 7°10'W. (Londonderry)
	f.g.	30.9.56	Revtangen, <b>Norway</b>
+		17.11.56	Camel Estuary: 50°32'N. 4°57'W. (Cornwall)
	ad.	22.7.54	Ottenby: 56°13'N. 16°25'E. Öland, <b>Sweden</b>
+		27.12.55	Sutton: 53°19'N. 0°15'W. (Lincolnshire)
	f.g.	2.8.52	Amager: 55°40'N. 12°38'E. <b>Denmark</b>
+		13.1.57	Holbrook: 51°59'N. 1°10'E. (Suffolk)
	f.g.	19.9.53	Amager, <b>Denmark</b>
×		ca.1.55	King's Lynn: 52°45'N. 0°24'E. (Norfolk)

**Great Black-backed Gull** (*Larus marinus*)

	O pull.	3.7.57	Arnanes: 64°17'N. 15°14'W. <b>Iceland</b>
+	(trap)	2.11.57	Drumbeg: 58°15'N. 5°12'W. (Sutherland)
	O pull.	5.7.55	Kinn: 61°35'N. 4°44'E. (Sogn & Fjordane) <b>Norway</b>
×		23.12.56	Cleethorpes: 53°33'N. 0°00' (Lincolnshire)
	O pull.	5.7.55	Kinn, <b>Norway</b>
×		19.10.56	Haverigg: 54°12'N. 3°19'W. (Cumberland)
	O pull.	6.7.55	Kinn, <b>Norway</b>
×		15.2.56	Jarrow Slake: 54°59'N. 1°28'W. (Durham)
	O pull.	20.6.51	Hovden: 61°43'N. 4°53'E. (Sogn & Fjordane) <b>Norway</b>
×		5.3.56	Aldeburgh: 52°10'N. 1°39'E. (Suffolk)
	O pull.	5.7.55	Bremanger: 61°44'N. 4°57'E. (Sogn & Fjordane) <b>Norway</b>
×		13.5.56	Burgh Marsh: 54°56'N. 3°04'W. (Cumberland)
	O pull.	29.6.56	Rott: 58°55'N. 5°30'E. (Rogaland) <b>Norway</b>
×		4.9.57	Breydon Water: ca.52°37'N. 1°42'E. (Norfolk)
	O pull.	29.6.56	Rott, <b>Norway</b>
×	(wires)	16.11.56	Great Yarmouth: 52°36'N. 1°46'E. (Norfolk)
	O pull.	29.6.56	Rott, <b>Norway</b>
×		16.12.56	Wensley: 54°18'N. 1°50'W. (Yorkshire)
	O pull.	6.6.56	Sokndal: 58°27'N. 6°08'E. (Rogaland) <b>Norway</b>
×		4.11.56	Theddlethorpe: 53°23'N. 0°14'E. (Lincolnshire)
	O pull.	15.7.55	Sokndal, <b>Norway</b>
×		2.2.57	Weston: 50°53'N. 1°23'W. Southampton (Hampshire)

**Lesser Black-backed Gull** (*Larus fuscus*)

	O pull.	10.7.55	Kinn: 61°35'N. 4°44'E. (Sogn & Fjordane) <b>Norway</b>
3	()	28.8.56	Leyton: 51°34'N. 0°00' (Essex)

**Herring Gull** (*Larus argentatus*)

O.	O	pull.	19.7.55	Vardö: 70°18'N. 31°07'E. (Finnmark) <b>Norway</b>
8526	v		21.12.55	Tynemouth: 55°02'N. 1°25'W. (Northumberland)
O.	O	pull.	19.7.55	Vardö, <b>Norway</b>
8796	/2/		0.12.56	Blair Drummond: 56°08'N. 4°03'W. (Perthshire)
O.	O	pull.	19.7.55	Vardö, <b>Norway</b>
8902	×	(nets)	29.10.55	Smith's Knoll Light-Vessel 52°37'N. 2°24'E.
O.	O	pull.	19.7.55	Vardö, <b>Norway</b>
8931	×		ca.14.2.56	Grimsby: 53°35'N. 0°04'W. (Lincolnshire)
O.	O	pull.	11.7.55	Vardö, <b>Norway</b>
091895	×		24.1.57	Canvey Island: 51°32'N. 0°35'E. (Essex)

These five records are the first to be received from this northernmost part of the Herring Gull's breeding-range in Europe.

**Kittiwake** (*Rissa tridactyla*)

M.	O	pull.	12.7.56	Murmansk Coast: ca.68°49'N. 37°20'E. <b>U.S.S.R.</b>
E285572	×		9.2.57	Gibraltar Point: 53°06'N. 0°21'E. (Lincolnshire)
M.	O	pull.	19.7.57	Murmansk Coast, <b>U.S.S.R.</b>
E431887	×		17.11.57	Walton-on-the-Naze: 51°51'N. 1°18'E. (Essex)

**Common Tern** (*Sterna hirundo*)

L.	O	pull.	23.6.56	Kampen: 52°31'N. 5°51'E. (Overijssel) <b>Holland</b>
K59782	×		6.9.56	St. Ouen: 49°12'N. 2°16'W. Jersey, Channel Is.

**Sandwich Tern** (*Sterna sandvicensis*)

L.	O	pull.	14.7.55	Den Helder: 53°58'N. 4°55'E. Noord <b>Holland</b>
254806	×		13.8.55	Northampton: 52°14'N. 0°54'W.
L.	O	pull.	14.7.55	Den Helder, <b>Holland</b>
254865	×		18.8.55	Jersey: Channel Is.

**Razorbill** (*Alca torda*)

M	O	pull.	22.7.56	Kandalaksha: 67°02'N. 32°35'E. <b>U.S.S.R.</b>
E462068	v		3.2.57	Fowey: 50°20'N. 4°37'W. (Cornwall)
	×		15.2.57	ibid.

This is the first ringed Razorbill from any foreign country to be recovered in the British Isles.

**Swallow** (*Hirundo rustica*)

B.	ad.	30.8.54	Gaurain-Ramecroix: 50°35'N. 3°29'E. (Hainaut) <b>Belgium</b>
9A4332	×	(at nest) 27.5.57	Camberley: 51°21'N. 0°44'W. (Surrey)

In connection with this, it is interesting to note the recovery-record of the Swallow (C. 24301) which appears in the earlier part of this "Report on bird-ringing for 1957". The bird with the Brussels ring can safely be considered as a British-bred one, so there are two natives of the South of England passing through the same town in Belgium, one on autumn migration and the other on what appears to be a late spring passage.

**Jackdaw** (*Corvus monedula*)

f.g. Autumn 1955 Copenhagen 55°41'N. 12°35'E. Denmark  
12.4.57 Benacre: 52°24'N. 1°43'E. (Suffolk)

**Fieldfare** (*Turdus pilaris*)

- 559 O pull. 14.6.53 Ustaoset: 60°30'N. 8°04'E. (Buskerud) Norway  
× 23.2.56 Tavistock: 50°33'N. 4°08'W. (Devonshire)
- 221 O pull. 20.6.53 Fana: 60°19'N. 5°27'E. (Hordaland) Norway  
× 5.3.56 Waterston: 51°43'N. 4°59'W. (Pembrokeshire)
- 003 O pull. 25.5.54 Naerbo: 58°38'N. 5°41'E. (Rogaland) Norway  
× 10.3.56 Romsey: 50°59'N. 1°29'W. (Hampshire)
- 779 O pull. 17.6.55 Volda: 62°09'N. 6°04'E. (Sunnmøre) Norway  
× 27.3.56 Ruthin: 53°06'N. 3°16'W. (Denbighshire)
- 740 ad. 28.10.55 Frøyland: 58°21'N. 6°18'E. (Rogaland) Norway  
× 21.1.56 Bottesford: 53°33'N. 0°38'W. (Lincolnshire)
- 550 O pull. 2.6.56 Aalesund: 62°27'N. 6°12'E. (Møre & Romsdal) Norway  
× (cat) 21.11.57 Lisburn: 54°32'N. 6°07'W. (Antrim)
- 071 O pull. 11.6.54 Oslo: 59°54'N. 10°46'E. Norway  
× ca.28.2.55 Ceres: 56°18'N. 2°55'W. (Fife)
- 553 O pull. 29.5.55 Nordfjordeid: 61°54'N. 6°00'E. (Sogn & Fjordane) Norway  
× 18.2.56 Plymouth: 50°22'N. 4°07'W. (Devonshire)
- O pull. 1.6.55 Heskestad: 58°28'N. 6°25'E. (Rogaland) Norway  
+ ca.1.2.56 Haddiscoe: 52°31'N. 1°35'E. (Norfolk)
- O pull. 3.6.55 Helleland: 58°28'N. 6°15'E. (Rogaland) Norway  
× 14.5.56 Cumwhitton: 54°52'N. 2°46'W. (Cumberland)
- O pull. 5.6.55 Helleland, Norway  
× 26.2.56 Haldon Moor: 50°38'N. 3°34'W. (Devonshire)
- 027 O pull. 10.6.55 Hamar: 60°48'N. 11°05'E. (Hedmark) Norway  
× 1.3.56 Larkhill: 51°12'N. 1°48'W. (Wiltshire)

**Redwing** (*Turdus musicus*)

- 004 O pull. 24.5.55 Oslo: 59°54'N. 10°46'E. Norway  
× 21.3.56 Lulworth Cove: 50°38'N. 2°15'W. (Dorset)
- 001 O pull. 3.6.55 Oslo, Norway  
× 6.11.55 Evesham: 52°05'N. 1°58'W. (Worcestershire)
- 554 O pull. 7.7.56 Sörmarka: 58°56'N. 5°43'E. Stavanger, Norway  
v 16.10.57 Fair Isle: 59°32'N. 1°37'W. (Shetland)

**Blackbird** (*Turdus merula*)

- 552 ♀ 26.5.53 Bygdøy: 59°54'N. 10°41'E. Oslo, Norway  
v 13.3.54 Isle of May: 56°11'N. 2°33'W. Firth of Forth
- 333 O pull. 29.5.56 Stokke: 59°11'N. 10°19'E. (Vestfold) Norway  
× (hawk) 3.12.56 Ballinamore: 54°52'N. 8°03'W. (Donegal)
- 87 ♂ 31.3.53 Nordfjordeid: 61°54'N. 6°00'E. (Sogn & Fjordane) Norway  
× 16.1.55 Aberchirder: 57°33'N. 2°38'W. (Banffshire)
- 190 v juv. 16.11.54 Loosduinen: 52°04'N. 4°15'E. Zuid Holland  
19.2.55 Oundle: 52°29'N. 0°28'W. (Northamptonshire)



PURCHASED  
22 DEC 1958

**Wheatear** (*Oenanthe oenanthe*)

Rk.	O	pull.	28.6.57	Skipalón: 65°47'N. 18°12'W. <b>Iceland</b>
96016	v		5.9.57	Dungeness Bird Obs. 50°55'N. 0°59'E. (Kent)

The British ring E.26151 was added.

**White Wagtail** (*Motacilla alba alba*)

Rk.		ad.	5.8.57	Skipalón: 65°47'N. 18°12'W. <b>Iceland</b>
96085	×		18.10.57	Cosheston: 51°42'N. 4°53'W. (Pembrokeshire)

**Starling** (*Sturnus vulgaris*)

M.		ad. ♂	27.5.54	Rybinsk area: 58°30'N. 37°30'E. <b>U.S.S.R.</b>
F201073	×		20.1.55	Goulceby: 53°18'N. 0°07'W. (Lincolnshire)
M.	O	pull.	4.6.56	Rybinsk area, <b>U.S.S.R.</b>
F304782	+		21.2.57	Martin: 51°11'N. 1°23'E. Dover (Kent)
M.		ad. ♂	30.5.55	Kandava: 57°08'N. 22°44'E. <b>Latvia</b>
F205801	×		13.12.55	St. Mary's: 49°56'N. 6°17'W. Scilly Is.
M.		ad. ♂	30.5.56	Kandava, <b>Latvia</b>
F212145	+		13.2.57	Gazeley: 52°15'N. 0°31'E. (Suffolk)
M.	O	pull.	3.6.56	Riga: 56°57'N. 24°07'E. <b>Latvia</b>
F306181	×		3.2.57	Wymondham: 52°33'N. 1°08'E. (Norfolk)
Stav.	O	pull.	27.5.56	Höyland: 58°50'N. 5°45'E. (Rogaland) <b>Norway</b>
736402	+		1.3.57	Higham: 53°34'N. 1°32'W. Barnsley (Yorkshire)
Stav.	O	pull.	6.6.57	Runde: 62°25'N. 5°38'E. (Sunnmøre) <b>Norway</b>
740232	×		24.10.57	Haisborough Light-Vessel: 52°58'N. 1°34'E.
O.	O	pull.	2.6.54	Heskestad: 58°28'N. 6°25'E. (Rogaland) <b>Norway</b>
085109	()		ca.20.1.55	Belfast: 54°35'N. 5°50'W. (Antrim)

**Chaffinch** (*Fringilla coelebs*)

L.		♂	24.10.54	Loosduinen: 52°03'N. 4°12'E. Zuid <b>Holland</b>
H27595	×		28.3.55	Dover: 51°07'N. 1°19'E. (Kent)
B.		♀	13.10.56	Opbrakel: 50°48'N. 3°45'E. (East Flanders) <b>Belgium</b>
18B336	×	(cat)	2.2.57	Cheltenham: 51°54'N. 2°04'W. (Gloucestershire)
P.		♀	11.10.57	Bousbecque: 50°44'N. 2°10'E. (Nord) <b>France</b>
JH0693	×		19.11.57	Henry's Moat: 51°54'N. 4°51'W. (Pembrokeshire)

**Brambling** (*Fringilla montifringilla*)

Stav.		ad.	10.2.55	Orelund: 59°08'N. 10°14'E. (Vestfold) <b>Norway</b>
939608	v.		0.10.56	Thames Estuary: ca.51°30'N. 0°40'E.

This Brambling was caught and released on board ship.

**Reed Bunting** (*Emberiza schoeniclus*)

L.		juv.	13.7.57	Leerdam: 51°54'N. 5°06'E. Zuid <b>Holland</b>
H49658	×	♀	21.11.57	Pett Level: 50°53'N. 0°43'E. (Sussex)

The first Reed Bunting ringed on the Continent to be recovered in the British Isles.



## LIST OF BIRD OBSERVATORIES IN THE BRITISH ISLES

This list is arranged alphabetically and is designed to give (i) the name of the warden or director where there is one; (ii) the address from which particulars may be obtained; and (iii) an indication of accommodation charges and travel routes (charges are, of course, liable to alteration).

- BARDSEY BIRD AND FIELD OBSERVATORY**, Caernarvonshire, N. Wales.  
*Warden*: R. W. Arthur. *Write to*: W. M. Condry, Felin-y-cwm, Eglwysfach, Machynlleth, Montgomeryshire. *Accommodation*: 4/- per night.  
*Station*: Pwllheli. *Boat from Aberdaron*: 11/- return.
- CLEY BIRD OBSERVATORY**, Holt, Norfolk. *Warden*: R. A. Richardson, Hill Top, Cley, Holt, Norfolk, from whom particulars may be obtained (please send stamped reply envelope). *Accommodation*: Cottage or hotel in Cley village. *Station*: Holt (4 miles).
- COPELAND BIRD OBSERVATORY**, N. Ireland. *Hon. Director*: J. G. Gray. *Write to*: G. T. Flock, 27 Hillside Park, Stranmillis, Belfast. *Accommodation*: 2/- per night. *Bus and Boat from Belfast*: 10/- return.
- DUNGENESS BIRD OBSERVATORY**, Romney Marsh, Kent. *Hon. Warden*: H. E. Axell. *Write to*: H. A. R. Cawkell, 6 Canute Road, Hastings, Sussex. *Accommodation*: 5/- per night. *Station*: Lydd-on-Sea.
- FAIR ISLE BIRD OBSERVATORY**, by Lerwick, Shetland. *Warden*: Peter Davis. *Write to*: George Waterston, 5 Charlotte Square, Edinburgh 2. *Accommodation and Board*: 15/- to £1 per night. *Station*: Aberdeen; then by steamer to Lerwick (£6 return) or by B.E.A. aeroplane to Sumburgh. *Island boat*: £1 1s. return.
- GIBRALTAR POINT BIRD OBSERVATORY AND FIELD STUDY CENTRE**, near Skegness, Lincs. *Bookings*: A. E. Smith, Pyewipes, Willoughby, Alford, Lincs. *Research*: R. K. Cornwallis, Bleasby Grange, Legsby, Market Rasen, Lincs. *Accommodation*: 6/- per night. *Station*: Skegness.
- ISLE OF MAY BIRD OBSERVATORY AND FIELD STATION**, Fife. *General correspondence*: Dr. W. J. Eggeling, Nature Conservancy, 12 Hope Terrace, Edinburgh 9. *Bookings*: J. H. B. Munro, 10 Comiston Place, Edinburgh 10. *Accommodation*: 5/- per night. *Station*: Pittenweem. *Boat*: 15/- return.
- JERSEY BIRD OBSERVATORY**, St. Ouen's Nature Reserve, Jersey, C.I. *Write to*: A. le Sueur, 6 York Street Chambers, St. Helier, Jersey, C.I. *Accommodation and Board*: £7 7s. per week (seaside café, *pro. tem.*). *Travel*: by steamer from Weymouth or Southampton (£5 5s. 6d., 2nd class return) or by B.E.A. aeroplane.
- LUNDY FIELD STATION AND OBSERVATORY**, via Bideford, Devon. *Warden*: W. B. Workman. *Write to*: Prof. L. A. Harvey, University of Exeter, Devon. *Accommodation and Board*: 5 to 6 guineas per week. *Station*: Bideford. *Boat* (M.V. "Lundy Gannet"): £2 5s. return.
- MONKS' HOUSE BIRD OBSERVATORY AND FIELD STATION**, Sea-houses, Northumberland. *Director*: Dr. E. A. R. Ennion, from whom particulars may be obtained at the address above (please send stamped reply envelope). *Accommodation and Board*: £7 to £9 9s. per week, or 30/- per day for less. *Stations*: Chathill (south) or Belford (north).
- PORTLAND BIRD OBSERVATORY**, Dorset. *Write to*: A. J. Bull, The Gallop, Bryanston, Dorset. *Accommodation*: 5/- per night. *Station*: Weymouth.
- GREAT SALTEE BIRD OBSERVATORY**, Co. Wexford, Ireland. *Write to*: Major R. F. Ruttledge, Cloonee, Ballinrobe, Co. Mayo, Ireland. *Accommodation*: 10/- per week. *Station*: Bridgetown (boat from Fishguard to Rosslare; train from Rosslare to Bridgetown). *Boat*: £1 return.
- SKOKHOLM BIRD OBSERVATORY**, Dale, Haverfordwest, Pembs. *Warden*: Mrs. Kate Barham, from whom particulars may be obtained at Dale Fort Field Centre, Haverfordwest, Pembs. *Accommodation and Board*: £6 16s. 6d. per week. *Station*: Haverfordwest. *Car and Boat*: £1 return.
- SPURN BIRD OBSERVATORY**, Kilnsea, Yorks. *Write to*: G. H. Ainsworth, 144, Gillshill Road, Hull. *Accommodation*: 3/- per night. *Stations*: Hull (bus to Kilnsea) or Patrington (taxi or bus).
- THE NEW GROUNDS**, Slimbridge, Gloucestershire (Headquarters of the Wildfowl Trust). *Hon. Director*: Peter Scott. *Assistant Director (Research)*: Dr. G. V. T. Matthews. *Write to*: Bookings Secretary, at address above.

In addition to the above observatories, two representatives from each of which form the Bird Observatories Committee, there are several which have not yet applied for formal recognition. These include: Bradwell (Essex), St. Agnes (Isles of Scilly), St. Kilda (Outer Hebrides) and Walberswick (Suffolk). Enquiries concerning these stations may be made through The Secretary, Bird-Ringing Committee, c/o British Museum (Natural History), London, S.W.7.

## A BRIEF HISTORY OF BIRD-RINGING IN THE BRITISH ISLES

---

Although from 1890 there had been several enterprises of limited scope, bird-ringing on a large scale in this country began in 1909 with the independent launching of two schemes—one by H. F. Witherby in connection with *British Birds* (rings marked "Witherby High Holborn London"), and the other by A. Landsborough Thomson in Scotland (rings marked "Aberdeen University"). Of these, the first-mentioned developed into the national scheme of today; the other came to an end during the First World War, its promoter afterwards becoming associated with Witherby's scheme.

In 1937 Witherby transferred the control of his scheme to the British Trust for Ornithology, which appointed a Bird-Ringing Committee to manage it: Miss E. P. Leach, who had latterly assisted Witherby, carried on the work as Honorary Secretary of this Committee. At the same time, the headquarters were moved to the British Museum (Natural History) where the Trustees had agreed to provide accommodation and also to allow the use of the Museum address on rings. *British Birds* continued to support the scheme and to be the chief medium of publication. The Leverhulme Trust made a non-current grant for special projects.

For a long time the scheme was mainly self-supporting, the ringers paying—as they still do—for the rings they used. Its rapid growth after the Second World War, however, eventually made it impossible to maintain the ever-increasing load of headquarters work on a voluntary basis, although some help towards expenses was afforded from the general funds of the Trust. Fortunately, the Nature Conservancy agreed to give financial support, at first on a small scale but from 1954 in an annual amount to cover the salaries of a whole-time Secretary (Robert Spencer) and other staff.

This substantial support and the continuing active co-operation of so many ringers are evidence of the importance attached to the scientific results. A report on progress, with a selected list of recovery records, is published each year in *British Birds*: from 1958 an extra number of the magazine is being entirely devoted to this and related purposes. Analyses of particular sections of the accumulated data are also published from time to time.

# BRITISH BIRDS



DECEMBER 1958

THREE SHILLINGS

# BRITISH BIRDS

AN ILLUSTRATED MONTHLY MAGAZINE

Edited by

E. M. NICHOLSON

W. B. ALEXANDER                      A. W. BOYD

I. J. FERGUSON-LEES

P. A. D. HOLLON                      N. F. TICEHURST

*Editorial Address:* 30, St. Leonard's Avenue, Bedford.

*Photographic Editor:* G. K. YEATES

Annual Subscription £2 (including postage and despatch)  
payable to H. F. & G. Witherby Ltd., 5, Warwick Court, London, W.C.1

---

CONTENTS OF VOLUME LI, NUMBER 12, DECEMBER 1958

---

	PAGE
Concealment and recovery of food by birds, with some relevant observations on squirrels. By T. J. Richards ... ..	497
The nature and characteristics of sub-song. By Dr. W. H. Thorpe and P. M. Pilcher (plates 69-74) ... ..	509
Intelligence tests with tits. By M. Brooks-King and H. G. Hurrell. Photographs by Peter Blomfield and Brian Pratt (plates 75-76) ...	514
Notes:—	
Breeding of Black-tailed Godwits in the British Isles (the Editors) ...	524
The winter status of the Greenshank in west Wales (J. H. Barrett and T. A. W. Davis) ... ..	525
Broad-billed Sandpiper in Hampshire: correction ... ..	527
Hoarding of food by Willow and Coal Tits (David Hart) ... ..	527
Recent reports and news. By I. J. Ferguson-Lees and Kenneth Williamson ... ..	528

---

Cover photograph by G. K. Yeates: Red-legged Partridge (*Alectoris rufa*) on nest



## BRITISH BIRDS

---

### CONCEALMENT AND RECOVERY OF FOOD BY BIRDS, WITH SOME RELEVANT OBSERVATIONS ON SQUIRRELS

By T. J. RICHARDS

THE FOOD-STORING INSTINCT occurs in a variety of creatures, from insects to Man. The best-known examples are found in certain Hymenoptera (bees, ants) and in rodents (rats, mice, squirrels). In birds food-hoarding has become associated mainly with the highly-intelligent Corvidae, some of which have also acquired a reputation for carrying away and hiding inedible objects. That the habit is practised to a great extent by certain small birds is less generally known. There is one familiar example, the Red-backed Shrike (*Lanius cristatus collurio*), but this bird's "larder" does not fall into quite the same category as the type of food-storage with which this paper is concerned. Firstly, the food is not concealed and therefore no problem arises regarding its recovery, and secondly, since the bird is a summer-resident, the store cannot serve the purpose of providing for the winter months.

In the early autumn of 1948, concealment of food by Coal Tit (*Parus ater*), Marsh Tit (*P. palustris*) and Nuthatch (*Sitta europaea*) was observed at Sidmouth, Devon (Richards, 1949). Subsequent observation has confirmed that the habit is common in these species and has also shown that the Rook (*Corvus frugilegus*) will bury acorns (*Quercus* spp.) in the ground, sometimes transporting the food to a considerable distance before doing so. This paper is mainly concerned with the food-storing behaviour of these four species, and is a summary of observations made intermittently between 1948 and 1957 in the vicinity of Sidmouth.

#### (I) COAL TIT

Throughout the autumn, from about mid-September onwards, parties of Coal Tits at beech trees (*Fagus sylvatica*) may be seen carrying away and hiding beech-nuts. They conceal each nut in a different spot, so that the food supply may be dispersed over an area of

up to 100 yards from its source. One bird flies to a larch and thrusts the nut into a tuft of lichen. Another drops to a bank, pushes the nut into the earth and, after tapping it in, rearranges the moss. A third carries its nut to the mossy trunk of an oak, taps it into a bark crevice and covers it with tufts of plucked moss. Where beech trees grow at the edge of a pine wood most of the nuts are hidden about the conifers, or on the ground under pine-needles and bracken. In gardens the nuts may be buried in flower beds and shrubberies. The intensity of these activities is naturally dependent upon the beech-mast crop. It was highest in 1948 and 1950, when the crop was heavy. In 1951 and 1957, when the crop failed entirely, very few Coal Tits were to be found in the woods during autumn and winter.

In spring and summer Coal Tits will store the seeds of Scots pine (*Pinus sylvestris*), which they pick from the open cones. The seeds are concealed about the lichen-covered branches or are carried to the ground and pushed deep into the roots of heather. Instances of this behaviour were observed on 12th June 1949 and 15th April 1955.

Two notes recently published by Hart (1958a and b) concern the storing of shelled peanuts by a Coal Tit and a Willow Tit (*P. atricapillus*). The Coal Tit deposited the nuts in a variety of places, including brussel tops, grass tufts, and between the petals of a chrysanthemum flower. The Willow Tit's favourite hiding-place was in the wire twists securing the chestnut palings of a garden fence.

## (2) MARSH TIT

Marsh Tits hide large quantities of nuts in autumn, beech-nuts chiefly, but probably hazel-nuts (*Corylus avellana*) as well. On 22nd November 1948, when few nuts were left on the trees and the tits were foraging on the ground, a Marsh Tit found and secreted on a near-by bank thirteen beech-nuts in succession. The fourteenth it took to a branch and ate.

Marsh Tits are notoriously fond of the berries of honeysuckle (*Lonicera periclymenum*), but it would appear to be the seed rather than the fruit that is the attraction. On 20th October 1950 I watched a Marsh Tit taking honeysuckle berries from a hedge to the fork of an oak, where it extracted the seeds. It then concealed each seed separately in the lichen which covered the oak trunk just below the fork. A honeysuckle berry contains some six or seven seeds, but the tit disposed of only one or two before flying down for a fresh berry. In all, the bird dissected four berries and concealed nine or ten seeds. The skin and the pulp of the fruit were evidently left in the fork.

Marsh Tits will also hide bread, or even fat, taken from bird-tables (Robinson, 1950; Almond, 1950) and there is a record of one bird storing a dozen small crab-apples (*Malus pumila*) in a recess at the base of a hawthorn (Campbell, 1950).

## (3) BLUE TIT AND GREAT TIT

While Blue Tits (*P. caeruleus*) and Great Tits (*P. major*) often associate with the autumn hoarding parties I have never yet seen them conceal food. Southern (1946) and Hinde (1952, p. 25) have observed Blue Tits doing so, but I doubt if the habit is at all common in this species, though the bird may be in the process of acquiring it through imitation. The Great Tit has a less commendable habit. It spends much of its time watching Coal Tits and trying to find the nuts they have hidden. More often than not the bird is frustrated by the efficiency with which the food is concealed, but Long (1950) watched a Great Tit successfully robbing caches made by a Coal Tit under moss on the roof of a house. It would seem that the Great Tit is something of a parasite; it stores no food itself but keeps company with birds that do, and so benefits by their industry. Owen (1945) records similar behaviour in Blue Tits, which were observed to badger Coal Tits and Marsh Tits and apparently search for their caches. Hart (*loc. cit.*) watched both Blue Tit and Great Tit remove peanuts (*Arachis hypogaea*) stored by other species.

Haftorn (1944, 1953, 1954) made a detailed study of the food-storing of tits in Norway. He found that Crested Tit (*P. cristatus*), Willow Tit, Coal Tit, Marsh Tit and Siberian Tit (*P. cinctus*) all stored food, whereas Great Tit and Blue Tit did not. He points out that all the food-storing tits (with the exception of the Marsh Tit) haunt coniferous forests, in which they remain during winter, while large numbers of Great and Blue Tits move to inhabited areas in winter to supplement their diet from food supplied by human beings. The Marsh Tit is an "outsider". "It stores, in spite of the fact that it belongs to the deciduous forests and in winter keeps to the same areas as the Great and Blue Tit, neither of which store" (Haftorn, 1954, pp. 118-119).

It has been shown that both Great Tit and Blue Tit exhibit a tendency to search for and rob stores made by other species. It is not unlikely that this tendency would inhibit the development of the storing habit. True, the Blue Tit stores to a slight extent, but personal observation suggests that the robbing of caches is less pronounced in this species than in the Great Tit.

## (4) ANIMAL MATTER STORED BY TITS

So far I have not seen tits hide anything but vegetable matter (nuts and seeds), but Southern (1946) and Owen (1945) observed Blue Tits, Coal Tits and Marsh Tits carrying away small black slugs and hiding them in ivy-clad stumps. Haftorn (1954, p. 45) refers to the storing of aphids by Coal Tits. He also found that 20% of the food stored by the Crested Tit consisted of animal matter (Haftorn, *op. cit.*, p. 39). This comprised largely insects in the early stages, especially larvae of Lepidoptera and Diptera, and saw-fly cocoons (Tenthredinidae). The methods used by the Crested Tit in preparing the victims for storing did not differ from

those used in preparing them for immediate consumption. Caterpillars were usually killed or paralysed by decapitation, after which they were beaten against a branch (*cf.* Nuthatch, below). Some of these larvae would struggle for days after the "execution" (Haftorn, *op. cit.*, p. 51).

#### (5) NUTHATCH

Nuthatches are inveterate hoarders. One or two of these birds will often consort with Coal Tits and participate with them in the garnering of beech-mast. Their methods and places of concealment are similar to those of the tits, and they invariably cover the nuts with the material nearest to hand. One bird that deposited food in a cavity on the bare trunk of a dead tree used chips and wood dust.

The Nuthatch probably hides food all the year round, except perhaps when feeding young. It certainly does so in the early part of the breeding-season. On 29th March 1949 a hen was seen to conceal food during a pause in the work of plastering the nest-hole. Other cases have been noted in April and May. In a note already published (Richards, 1949) I described a cock Nuthatch's concealing a hazel-nut on 17th May 1948. The bird inserted the nut into a small round hole in a slender ash-pole and then plugged the hole with a tuft of lichen. The place of concealment was only a few yards from the nest-hole in which the hen was incubating.

The main items stored by Nuthatches are nuts, acorns and small seeds, but they will hide almost anything edible. Birds which live near gardens will make repeated visits to a bird-table and carry off pieces of bread, which they stow carefully away into bark crevices, covering each with a wisp of moss or lichen. Large crusts are broken up and hidden piece by piece. A nut or acorn may also be hidden piecemeal.

The Nuthatch does not confine itself to the storing of vegetable matter. On 13th April 1953 a hen, presented with a large caterpillar or grub by her mate, shook it several times before banging it against a branch, evidently to incapacitate it. Then she carried it to another tree and stowed it away into a tuft of lichen.

The following October (10th) I watched a Nuthatch banging at an oak branch, flicking out its wings as if it were hammering a nut, and prising off small pieces of wood. Presently it extracted a grub, which it took to another part of the branch and, with screwing movements of head and bill, inserted it deep into the lichen. Returning to the source of supply, the bird soon found another grub, which it concealed near the first. It then found a third and concealed that also before flying to another tree. In instances of this kind it would be interesting to know whether the victims are killed, or merely disabled, before being stored.

#### (6) JAY AND ROOK

In my experience the Jay (*Garrulus glandarius*) and the Rook are the only corvine birds that conceal food anything like as



intensively as Coal Tit, Marsh Tit and Nuthatch. Jays are especially fond of acorns and in autumn take a good many from the trees and bury them in the ground (see also Goodwin, 1951, 1956; Chettleburgh, 1952; and others). The acorns may be buried in meadow and parkland, close to the parent tree, or in woodland, often a considerable distance from the source. Jays will also carry acorns well out into open moorland and bury them in heath and heather. This transportation of acorns by Jays is a common enough sight in autumn, but it is not so easy to observe these wary birds in the act of burying the food. The planting of acorns is more easily observed in Rooks.

In early autumn Rooks begin to frequent the oaks, fluttering awkwardly on the outer sprays to take the ripening acorns. Some of the birds eat the fruit at once, hacking it to pieces on a branch or on the grass below; but observation will often show that many are burying acorns. On the few occasions when I have obtained a clear view of a Rook's burial of an acorn its methods were as follows. Gliding 30-40 yards out into the meadow, the bird alights with its acorn and struts about in search of a suitable place to bury it. Suddenly it pauses, tosses the acorn aside and proceeds to dig a hole with its bill. It then drops the acorn into the hole, taps it home and covers it with soil and loose grass. Occasionally a bird will bury the same acorn several times before the job is completed to its satisfaction. Rooks will work thus for a considerable time, yet a subsequent examination of the field will reveal no sign of their labour.

Goodwin (*in litt.*) states that the above observations seem to show that the Rook's technique differs from that of other corvine birds. He writes:—"All those I have seen bury food—Carrion Crow (*Corvus c. corone*), Hooded Crow (*Corvus corone cornix*), Magpie (*Pica pica*), Blue Magpie (*Urocissa erythrorhyncha*), Green Magpie (*Cissa chinensis*), Azure-winged Magpie (*Cyanopica cyanus*), Lanceolated Jay (*Garrulus lanceolatus*), Pileated Jay (*Cyanocorax cyanopogon*), British Jay—have first pushed the food into some existing cavity or into the earth, grass or other substrate and then covered it up. In no case have I ever seen the bird dig a hole for the food first."

However, after writing the first draft of this paper I came across a note which corroborates my own description of the Rook's methods (Gibbard and Bolderston, 1947). On 28th October 1947, at Thorverton, Devon, these two observers watched a party of some 25 Rooks which "carried acorns to two fields half-a-mile away, and after digging holes in small depressions in the fields, carefully planted them in the holes, tapping them in with their bills". The birds were observed for upwards of an hour, and it was estimated that at least 300 acorns were planted.

Rooks may bury acorns a mile or more from the parent tree. The Sid Vale is bounded on the west by Peak Hill, which terminates at the seaward end in a triangular escarpment some 500 ft. high. From the summit of this escarpment, during any

year from October to mid-December, Rooks can be seen carrying acorns from one valley to the next. As the crow flies the distance is approximately one mile, but as these Rooks fly it is at least double that distance. The birds take the acorns from trees in the Sid Vale and fly down the valley for about half-a-mile until they reach the coast. Then, utilizing upward air-currents, they drift westward along the cliffs to the next valley, where they turn inland, glide down to the grass fields and bury the acorns. By taking this route the birds save themselves the trouble of labouring over the hill. Two-thirds of their journey is accomplished with hardly a flap of a wing. Sometimes, however, when the wind is in the north or north-east, they pass directly over the hill, often circling at first to gain the necessary elevation. The return journey is almost invariably made by the most direct route.

The birds travel singly and in small parties, but it is difficult to estimate the total number of participants. While work is in progress the flock is dispersed over two valleys and along the routes between. In an hour 30 Rooks may pass westward, conveying in all something like 40 acorns. For the most interesting feature of this long-distance transportation is that some birds carry two acorns—one between the mandibles and one in the throat-pouch. Rooks which bury acorns only a few yards from the tree always appear to take them singly; and it is tempting to infer that some of the long-distance travellers realise that they make their journey more worthwhile by conveying a double quantity. Although this inference seems highly anthropomorphic, it is not easy to find an alternative explanation. Goodwin (*in litt.*) informs me that Jays, which are capable of carrying six or more acorns, also take fewer when burying them close to the tree.

The carrying and planting of acorns by Rooks may continue for about 10 weeks. Late in the season, when the supply of acorns from common oak (*Quercus robur* and *petraea*) and Turkey oak (*Quercus cerris*) is exhausted, the birds take the acorns of holm oak (*Quercus ilex*). Why they should carry the food for a distance of some two miles before burying it is not entirely clear, but two points are worth noting: one, that oaks are comparatively scarce in the valley to which the acorns are conveyed; and two, that the fields of this same valley are regularly used as feeding-grounds by Rooks in winter. Some 20 pairs of Rooks breed at the lower end of the Sid Vale; these are presumably the birds that transport and bury the acorns.

#### (7) RECOVERY OF CONCEALED FOOD BY SQUIRRELS

Before we can assess the value of the food-storing instinct to the animal possessing it we must know something of the extent to which that animal recovers the food it has hidden, not only from other creatures but from itself. Although we are primarily concerned with this question in relation to birds I feel it would not be irrelevant to include a short digression on the means by

which hidden food is recovered by the Grey Squirrel (*Sciurus carolinensis*).

The old idea that squirrels accumulate many nuts and acorns in one place and draw upon the store in time of need is now unacceptable. On the other hand, there is a common belief that, because the animals bury the nuts haphazardly, one here, one there (and most likely forget where they have put them), they recover only a fraction of the hidden food, and that by chance. The truth seems to lie between these two conceptions. Squirrels undoubtedly disperse the food over a wide area, burying each nut or acorn separately, and almost certainly forget the hiding places. Yet when food becomes scarce they probably recover 80-90% of their scattered hoards.

Grey Squirrels appear to spend autumn and winter, singly or in pairs, within a definite territory, over which they distribute the buried food. Watching them, not only burying the food but also digging it up and eating it later in the year, I became convinced that they found their caches by sense of smell. This was not difficult to prove. In areas occupied regularly by squirrels, nuts and acorns were buried about one inch deep in moss-covered soil and the places marked. Many of my caches were situated on low banks frequently traversed by the animals; others were made in mossy places between the roots of trees. Of 21 nuts or acorns buried between mid-October and the end of December 1952, only 4 had not been found and removed by 31st January 1953. The time taken to discover the food varied from 2 to 27 days.

The experiment clearly showed that a squirrel in search of food does not scratch at random. Having detected—presumably by smell—the presence of a buried nut, it digs a neat hole straight to it. So neat were some of the excavations that I at first suspected that mice were raiding the caches. To make sure, I erected small crossed arches of bent twigs over some of the caches, so that a mouse could gain access to the food without seriously disturbing the twigs. Over others I placed stones which were too heavy to be moved by any creature smaller than a squirrel. The stones were always removed, sometimes to a distance of a foot or more; the twigs were scattered or pushed roughly aside. Moreover, where an acorn or nut had been eaten on the spot the rejected skins or shells provided evidence that was significant to one who knows the squirrel's feeding habits.

We see then that the Grey Squirrel, aided by a keen sense of smell, has no difficulty in recovering its buried nuts. The question how the animal knows where to look for the food is not so easily answered. To recall the exact situations of several hundred buried nuts would be beyond even the powers of Man. But is it not possible that squirrels at least remember that they *have* hidden food and know approximately where to search for it? Grant the animal a glimmer of memory, and with its highly-developed sense of smell it would be well equipped for recovering its dispersed store.

After I had carried out my experiments and had drawn my conclusions a paper by an American observer came to my notice (Cahalane, 1942). Cahalane conducted similar but more elaborate experiments on the Western Fox Squirrel (*Sciurus niger rufiventer*). He not only planted caches of his own, he also marked many of those made by the squirrels. By the spring about 99% of the squirrel-made caches, and 83% of those made by the observer, had been emptied. The results indicated that memory is used to some extent in recovering food; but they also showed that the sense of smell is the chief faculty employed. Captive Fox Squirrels had no difficulty in locating nuts buried in moist soil, but if the soil was dry they were frequently at fault. Moisture intensifies the odour of the food. Cahalane concluded "that the memory pattern may be of assistance in general location, but that the sense of smell is depended upon and is highly accurate in locating particular nuts".

#### (8) RECOVERY OF CONCEALED FOOD BY BIRDS

It is much more difficult in birds than in squirrels to estimate what proportion of the concealed food is eventually recovered. From casual observation I should say that birds recover a large proportion, though it is not suggested that they, any more than squirrels, remember the exact hiding-places. It is not necessary that they should. The food has been widely distributed over areas where they habitually forage in winter. Parties of tits and pairs of Nuthatches may be seen working limited areas throughout the winter, tirelessly examining tree-trunks, twigs and branches, flaking off bark, moss and lichen. Haftorn (1954, p. 20) could find marked tits day after day throughout the winter in the same district. As I have observed in November, December and January, tits and Nuthatches certainly find many of the nuts they have hidden, sometimes only to hide them again in different places. This "store transplanting" also occurs in the Crested Tit (Haftorn, *op. cit.*, p. 94) and in the Jay (Goodwin, 1956). Rooks, too, as they prod about in the fields, must unearth a considerable proportion of their buried food. On 6th February 1950 Rooks were observed digging up and eating acorns in a meadow where this species had been seen burying the food the previous autumn.

Recovery of food by the smaller birds is perhaps largely a matter of trial and error, but aided to a small extent by the "memory pattern". Haftorn (*op. cit.*, p. 122) concluded that "the tits store collectively and therefore find and eat one another's stores. This means that they do not need to remember the exact situation of each stored object".

On the other hand, certain corvine birds do appear to remember the exact sites of their caches. Goodwin (1956) witnessed the retrieval of food by Jays on many occasions. Successful recovery is preceded by two different types of behaviour. First, the bird goes straight to the hiding-place and uncovers the hidden food (here everything suggests that the Jay had remembered the hiding-

place); second, it finds the food after prolonged searching in just those places in which a Jay would be likely to hide food. Two possible explanations for the latter behaviour are suggested: "Either the bird is seeking food which it has buried, but owing to subsequent alteration of the earth's surface (through growth or death of herbage, treading of cattle, working of moles and so on) is unable to re-locate with exactitude, or else it is deliberately searching in likely places for food which its mate has hidden". In either case all evidence points to the fact that the Jay recovers its stored food by means of a remarkably retentive memory. A recent note by Hayman (1958) suggests that the same applies to the Magpie. Yet there are some aspects of food-recovery which are difficult to explain purely in terms of memory, e.g. a bird's ability to locate buried food when the ground is covered by deep snow.

On 22nd February 1947 I saw a Jay dig straight down through snow, pick up what appeared to be a hazel-nut, and fly off with it. It seems unlikely that the bird found the nut by chance, but it is equally unlikely that it remembered and recognized a previous hiding-place after snow had altered the appearance of the ground. Cahalane (1944) observed a similar incident concerning a Clark's Nutcracker (*Nucifraga columbiana*). He found, after flushing the bird, that it had dug a hole through 8 inches of hard-packed snow to a Douglas fir cone (*Pseudotsuga taxifolia*) which was frozen to the ground litter. Evidence of another nutcracker's ability to find food in snow-covered ground is provided by Swanberg (1951).

Swanberg spent many years studying the Thick-billed Nutcracker (*Nucifraga c. caryocatactes*) in Central Sweden. In Scandinavia, where *Pinus cembra* does not occur, the Nutcracker's diet consists almost entirely of hazel-nuts. These, however, are available for only two or three months in autumn; so from late August until the supply of nuts is exhausted the bird devotes most of its time to food storage. The nuts are carried from hazel coppices to the bird's spruce-forest haunts (sometimes a distance of as much as 6 kilometres) and are there buried in the ground in small heaps at a depth of a bill's length. The bird's ability to re-locate these stores, even when they lie beneath 18 inches of snow, is extraordinary. Swanberg counted the number of excavations in the snow with nutshells in or near them, and also those which were apparently the result of unsuccessful searching. Out of 351 excavations examined the bird had dug straight to the food in 86%. Moreover, there were indications that the bird remembers which stores it used earlier in the winter. "Thus it practically never searches for a store already emptied, even if new snow has fallen".

This performance suggests something more than memory; it suggests the Squirrel's highly-efficient methods—memory plus sense of smell. Birds are supposed to possess little or no sense of smell, though Hudson (1922) was convinced that the faculty was highly developed in certain British Corvidae and provided

reasonable evidence for his convictions. On the other hand, Swanberg does not believe that the Nutcracker is aided by a sense of smell. He informs me (*in litt.*) that he has buried nuts from October to early spring in feeding places within the territories of Nutcrackers and that the birds were quite unable to find these "stores" even though they were hidden only by a thin covering of snow or moss.

Yet, if we deny the Nutcracker an olfactory sense, how are we to account for the accuracy with which it locates food lying beneath deep snow? For a bird to remember the exact position of a buried store it must presumably (consciously or unconsciously) note minutely the appearance of the immediate environment and retain a mental image of the site. Such an image, however, could be of little assistance to the bird if there occurred a subsequent alteration in the appearance of the ground. Goodwin (1956) has suggested that prolonged searching by Jays might be a result of their being at fault owing to subsequent change in vegetation or ground. Yet it would seem that the Nutcracker is able to locate 86% of its stores after all visual guides have been obliterated by snow. The incident of the Clark's Nutcracker described by Cahalane (*loc. cit.*) is of special interest, since the bird dug straight to a fir cone which was frozen to the ground litter. Here, evidently, the cone had not been previously buried by the bird but had been lying on the surface of the ground until covered by snow. In this case memory could have played no part in the discovery of the food.

Swanberg's paper (*loc. cit.*) contains no reference to squirrels, but it seems reasonably certain that the Red Squirrel (*Sciurus vulgaris*), which occurs in Sweden, would be capable of smelling out and raiding stores made by Nutcrackers. The possibility that this might occur and cause error in computing the percentage of stores recovered by the Nutcracker was suggested by a photograph in this paper (Fig. 5, p. 550). The photograph shows an excavation dug out by a Nutcracker with the shells of six hazelnuts scattered about it. These shells had clearly been split lengthwise into clean halves, and therefore closely resembled the work of a squirrel. While I had little doubt that Swanberg had taken these facts into consideration, I wrote to ask him if it was at all possible that some of the excavations attributed to Nutcrackers could have been, in fact, the work of Red Squirrels.

Swanberg replied that he had seen no signs of Red Squirrels raiding the Nutcrackers' stores, though he had thought that mice and voles (*Clethrionomys*, *Apodemus*) might be responsible for some of the 14% "unsuccessful" excavations. This opinion was based on experience gained from artificially arranged "stores" in the forest. He added that the splitting of nuts lengthwise into clean halves is characteristic of the Nutcracker, and that the bird's hacking with slightly opened bill not uncommonly results in double scratches on the shell. These scratches are usually distinguished without much difficulty from those made by the

squirrel. With this point clarified, I can only add that we have yet to learn the precise nature of the faculty employed by Nutcrackers in locating food buried beneath deep snow.

#### (9) FOOD STORAGE AND SEED DISPERSAL

In Norway tits store food exclusively in the trees (Haftorn, 1954, p. 115). In this country, as I have shown, Coal Tits and Marsh Tits store not only in trees but also in the earth, in ground litter, and on banks. The Nuthatch does the same; it also conceals food in crevices on walls. Although these birds probably recover 90% of the food they hide about the trees they overlook many nuts and seeds which they bury, or conceal elsewhere. This is evident to anyone who walks about the country bearing in mind that certain trees rely almost entirely upon the food-hoarding instinct for their seed dispersal. In pine woods, beech-seedlings known to have been planted by Coal Tits are found growing 100 yards or so from the nearest beech. In Nuthatch territory young trees of beech, oak and hazel sprout from the steep sides of mossy banks; and in rough flint walls near gardens stunted seedlings of yew (*Taxus baccata*) and beech are firmly rooted in crevices where the seeds could not have dropped by chance. On moors, some distance from mature timber, oak saplings growing amongst heather show clearly that Jays also overlook a fair proportion of their buried acorns. In Czechoslovakia there is a large pine forest, half of which now has an oak undergrowth as a result of Jays' burying acorns there during the past 25 years (Goodwin, 1953, citing Turcek, 1950). It would seem that birds have a greater influence than squirrels upon the reproduction and dispersal of forest trees. Squirrels appear to be too efficient to allow many of their planted seeds to germinate.

#### CONCLUSION

It would be interesting to know how the food-storing habit in birds originated. In the Nuthatch, which habitually fixes its food in bark crevices, it is likely that storing began with the bird's carrying off and wedging more food than it required for immediate use. But the next stage—concealing the food with moss or lichen—would appear to require something like foresight. Tits do not wedge food in crevices; they hold it firm with the foot. These birds, however, are quick to learn by imitation, and it is possible that they acquired the storing habit from the Nuthatch, with which they regularly consort. That the habit is now purely instinctive is demonstrated when a Coal Tit, storing a nut on a bare tree trunk, "covers" the food with non-existent material (Richards, 1949).

The Great Spotted Woodpecker (*Dendrocopos major*) fixes galls and nuts in bark crevices before hacking them to pieces; but at times it will insert them and leave them intact. Later they may be found by accident and utilized. Have we here the habit in its

elementary stage? Perhaps in the course of time, if the custom be advantageous to the species, this woodpecker will learn to conceal its surplus food.

## ACKNOWLEDGEMENTS

My thanks are due to the editor of *The Countryman* for permission to reproduce material published as an article in that journal. I am also grateful to Mr. Derek Goodwin for the loan of certain papers and for offering helpful criticism, and to Mr. I. J. Ferguson-Lees for much encouragement and advice.

## REFERENCES

- ALMOND, W. E. and E. L. (1950): "Concealment of food by Marsh Tit". *Brit. Birds*, xliii: 336-337.
- CAHALANE, V. H. (1942): "Caching and recovery of food by the Western Fox Squirrel". *Journal of Wildlife Management*, Vol. 6, No. 4.
- (1944): "A Nutcracker's search for buried food". *Auk*, 61: 643.
- CAMPBELL, W. D. (1950): "Concealment of food by Marsh-Tit". *Brit. Birds*, xliii: 336.
- CHIETLEBURGH, M. R. (1952): "Observations on the collection and burial of acorns by Jays in Hainault Forest". *Brit. Birds*, xlv: 359-364.
- GIBBARD, S. D. and BOLDERSTON, W. N. (1947): In *20th Report Devon Bird-Watch. Soc.*, p. 5.
- GOODWIN, D. (1951): "Some aspects of the behaviour of the Jay (*Garrulus glandarius*). Pt. II. *Ibis*, 93: 602-625.
- (1953): "Birds and the woods". *Bird Notes*, xxv: 312-314.
- (1956): "Further observations on the behaviour of the Jay (*Garrulus glandarius*)". *Ibis*, 98: 211-213.
- HAFTORN, S. (1944): "Hamstring hos meiser". *Naturen*, 68: 58-63.
- (1953): "Observasjoner over hamstring av naering hos lappmeis (*Parus c. cinctus*, Bodd)". *Det Kgl. Norske Vidensk. Selsk. Forh.*, 26: 76-82.
- (1954): "Contribution to the food biology of tits, especially about storing of surplus food. Pt. I. The Crested Tit (*Parus c. cristatus*. L)". *Det. Kgl. Norske Vidensk. Selsk. Skrifter*, 1953, Nr. 4.
- HART, D. (1958a): "Hoarding of food by Willow Tit". *Brit. Birds*, li: 122.
- (1958b): "Hoarding of food by Coal Tit". *Brit. Birds*, li: 122-123.
- HAYMAN, R. W. (1958): "Magpie recovering and burying food". *Brit. Birds*, li: 275.
- HINDE, R. A. (1952): "The behaviour of the Great Tit (*Parus major*) and some other related species". *Behaviour*, Suppl. II.
- HUDSON, W. H. (1922): *A Hind in Richmond Park*. (Dent, London, 1951 edition, pp. 117-121.)
- LONG, D. A. C. (1950): "Concealment of food by Coal-Tit". *Brit. Birds*, xliii: 335-336.
- OWEN, J. H. (1945): "Unusual feeding behaviour of tits". *Brit. Birds*, xxxviii: 173.
- RICHARDS, T. J. (1949): "Concealment of food by Nuthatch, Coal Tit and Marsh Tit". *Brit. Birds*, xlii: 360-361.
- ROBINSON, M. G. (1950): "Concealment of food by Marsh-Tit". *Brit. Birds*, xliii: 336.
- SOUTHERN, J. B. (1946): "Unusual feeding behaviour of tits". *Brit. Birds*, xxxix: 214.
- SWANBERG, P. O. (1951): "Food storage, territory and song in the Thick-billed Nutcracker". *Proc. 10th Int. Orn. Congr.*, Uppsala, June 1950, pp. 545-554.
- TURCEK, F. (1950): "O vztahu sojky (*Garrulus glandarius* L.) k obnove dubu (*Quercus* sp.)". *Lesnická Práce*, 29: 385-396.



# THE NATURE AND CHARACTERISTICS OF SUB-SONG

By W. H. THORPE and P. M. PILCHER

(Madingley Field Station, Department of Zoology,  
Cambridge University)

(Plates 69-74)

## INTRODUCTION

AVICULTURALISTS and bird fanciers have long used the term "recording" to denote the quiet "practice-like" singing so often heard from their pet birds before they come into the phase of true song. It has often been asserted that the instrument known as the Recorder originally took its name from the bird flageolet which was used by bird fanciers for teaching tunes to Canaries (*Serinus canarius*), Bullfinches (*Pyrrhula pyrrhula*) and other song birds, but we are indebted to R. Thurston Dart for a recent reference (Trowell, 1957) which shows that this is in fact improbable; it seems more likely that the bird song was named from the instrument—as indeed Daines Barrington (1773) supposed.

Early aviculturalists must have noted from time to time the utterance by birds in the wild of sounds similar to their "recording" and there is no doubt that many of the early naturalists (for example, Daines Barrington) refer in their writings to sub-song, either as "recording" or without giving it a definite name. E. M. Nicholson has reminded us of Gilbert White's mention of the contrast between "the Blackcap's loud and wild pipe" and its "sweet but inward melody" and Miss E. M. Barraud has given us the reference in Charles Darwin's *Descent of Man*: "The first attempts to sing 'may be compared to the imperfect endeavour in a child to babble'. The young males continue practising, or as the bird-catchers say, 'recording', for ten or eleven months. Their first essays show hardly a rudiment of the future song; but as they grow older we can perceive what they are aiming at; and at last they are said 'to sing their song round'" (mainly quoted by Darwin from Daines Barrington).

As far as we are aware, Nicholson (1927) was the first to employ the term "sub-song", and in 1931 (p. 61) he gave a number of suggestions aimed at helping field naturalists to observe and keep notes of important variations in pattern and intensity of song. The use of the term was later developed by Nicholson and Koch (1936) simply to mean "quiet song"—that is, song of low volume. It was taken to include "all performances which are so inwardly or faintly uttered that they do not carry to anywhere near the distance over which the bird is physically capable of making itself heard". Nicholson alone adds that it has no territorial influence and provokes no visible hostility in other males. Obviously this use of the term does not imply that there is

necessarily any real difference between the sub-song and the true song except in the matter of volume and territorial significance. The term "sub-song" has been used merely to indicate volume difference by Lister (1953) and by Armstrong (1955) with reference to the Wren (*Troglodytes troglodytes*). It is clear that Armstrong uses the term to include three or four important varieties of "quiet song", some with clear social significance, others with apparently none at all. In the present paper we are attempting to restrict the term "sub-song" to one form of quiet song about which a certain amount is already known. As other forms of quiet song come to be further studied, no doubt precise names will have to be found for them.

#### SUB-SONG OF THE CHAFFINCH

In the course of intensive study of the song learning of the Chaffinch (*Fringilla coelebs*) carried out over a number of years (Thorpe, 1955, 1958), a good deal of information about the sub-song of this species was obtained. Full details will be found in the papers referred to above. The matter can be summarized by saying that the sub-song of the Chaffinch is not merely song of low intensity but differs from the full song in many other respects. Whereas the true song consists of a well defined burst of sound lasting, on the average, between two and three seconds and repeated at intervals of about 20 seconds, the sub-song consists of an irregular and indefinite series of notes continuing for perhaps half a minute or more, although broken up into ill-defined phrases each lasting for perhaps two or three seconds.

The notes in the Chaffinch sub-song are very variable, but they fall into two groups. The first group includes a variety of chirping and cheeping notes, and the second group a series of somewhat mechanical-sounding rattles of varying pitch. The simplest type, which is usually heard from young males in their first autumn consists of a series of chirping notes fluctuating in pitch. During this autumn period the beak is often closed while singing and the rattle is heard only infrequently. Females occasionally give a similar sub-song. In the early spring the sub-song is resumed and after a week or so the bird may be spending quite a lot of its day in producing these utterances. Sound spectrograms show that most of the notes themselves are entirely different in structure from those which go to make up the full song and are particularly characterized by containing a much bigger range of frequencies—that is to say, they are very indefinite in pitch.

This sub-song seems to have no communicatory function, for it is extremely difficult to observe that a Chaffinch hearing sub-song is in any way influenced by it except that it may be induced to start singing itself. This, however, is not a characteristic response since almost any quiet, high-pitched noise such as the hissing sound made by the running of a tap will tend to start the birds singing.

Sub-song seems to be most frequently and consistently produced by first-year males in the early spring, although it is also produced by older birds and seems in general to be characteristic of the increasing production of sex hormone. The opinion of the bird fanciers that "recording" is in the nature of practice is, to some extent, borne out by our own studies, in that the sub-song does seem to provide in some degree the raw material out of which, by practice and by the elimination of unwanted extremes of frequency, the full song is, so to speak, crystallized. This "crystallization" consists of the building up of a comparatively complex song on the basis provided by the innate or inborn song. This building up to some extent involves picking up notes and phrases from other Chaffinches with which the bird may be singing in competition in its territory, and partly entails the incorporation of sounds characteristic of the sub-song.

Although the sub-song of the Chaffinch in the wild is sometimes associated with territory and may be given both from song posts or while feeding or preening on the ground, it is perhaps more often given from fairly dense cover. This is undoubtedly one of the reasons why it is so frequently overlooked by the field observer, the quality of the notes being such that the naturalist who knows only the true song would probably not recognize the utterance as coming from the Chaffinch at all.

One very striking feature observed when one studies records of the transition of the sub-song into the full song is the fact that at least some part of the process consists in discarding those more extreme frequencies which are not required in the latter. The belief that the sub-song is of no communicatory function is supported by the fact that wild Chaffinches are not "imitative" birds in that they will not normally include in their true song sounds other than those which they have heard in the full songs of other Chaffinches. Yet when they sing the sub-song they are much less particular and it has been possible to recognize notes and phrases copied from Canaries, tits (*Parus* spp.) and other birds in the sub-songs of our experimental Chaffinches.

If, then, we base our conclusions on the Chaffinch, which has been studied far more thoroughly than any other species, we might decide that sub-song differs from true song in the following respects:

- (1) The main fundamental frequency of pitch of the notes is apt to be lower than in the full song.
- (2) The frequency (or pitch) range of the sub-song as a whole and of the individual notes of which it is composed tends to be greater.
- (3) The sub-song is much quieter.
- (4) The overall pattern of note comprising the utterance is entirely different.
- (5) The length of the phrases of the song bursts is different, tending to be longer.
- (6) The sub-song is characteristic of lower sexual motivation, being generally produced earlier in the breeding season.

- (7) There is some evidence that, especially in young birds, the sub-song is in the nature of practice for the true song.

Having established these points of difference with regard to the Chaffinch, it obviously becomes interesting to enquire whether similar differences hold good with other species. In the course of our work at Madingley we have recorded a few examples of sub-song in species other than the Chaffinch, but these would not have been sufficient to warrant an article such as this, had it not been for the generosity of the British Broadcasting Corporation in placing at our disposal some years ago a complete set of the bird song records in their collection and, further, in keeping this up to date as new records were acquired. We have, therefore, worked through all the records in this splendid collection which are labelled sub-song or which, because of their low volume or other characteristics, suggest that they might be included in this category.

In addition to the B.B.C. records, we are much indebted to Professor P. Kellogg, of Cornell University, for providing us with copies of a number of records of American bird songs where a good deal of individual variation is shown, some of which may be regarded as sub-song. It stands to reason that sub-song as at present defined is only likely to be recognized in species of which the full song is a loud and fairly stereotyped utterance in use as a territorial proclamation. In other species where the song seems to have but little territorial function and indeed seems to serve primarily, if not exclusively, as a component of sexual display and for maintaining and co-ordinating the behaviour of a mated pair through the breeding season, the usefulness of the term "sub-song" is at present very doubtful.

#### SUB-SONG OF THRUSHES

The European thrushes supply the best material, apart from the Chaffinch, for the study of sub-song. The Blackbird (*Turdus merula*) and the Song Thrush (*T. philomelos*) both provide examples of what appears to be sub-song, answering in every respect to the provisional definitions set forth above. Figs. 1-4 (plates 69 and 70) show examples of the sub-song of both these species as compared with the characteristic phrases from the full song, and in both species there is evidence suggesting that the sub-song is in the nature of practice. The Mistle Thrush (*T. viscivorus*) (Figs. 5 and 6, plate 70) also provides some good examples of sub-song except that we have no clear evidence that the average main frequency of the fundamental is, in this case, any lower; nor is there any very impelling reason to think that the sub-song is practice in this species. The same is true of the Redwing (*T. musicus*) (Figs. 7 and 8, plate 71) except that here there is a slight increase in the main frequency of the notes when the transition to the full song occurs.

## OTHER SPECIES (FINCHES, BUNTINGS, ETC.)

In none of the other species we have investigated is there any particular reason to suppose that the sub-song serves as practice, although, of course, it must be remembered that the estimation of the evidence of this is at best a subjective matter and unless one has very prolonged experience of a number of individuals one cannot be at all definite about it. It seems probable from observations on the Brambling (*Fringilla montifringilla*) in our aviaries that the full song of this species is simply the "zee" note repeated with minor variations and that more complex utterances, which include a "churring" sequence of about 0.7 seconds duration, are eliminated as full sexual motivation develops with the season. Apart from this, however, there are a number of other cases of what seem to be genuine sub-songs. Both the Canary (*Serinus canarius*) and the American Goldfinch (*Spinus tristis*) (Figs. 9-12, plates 71 and 72) have sub-songs which are typical enough in all respects save that there is no marked difference in the duration of the song bursts as between the two types of utterance. Neither do the records we have of the American Goldfinch suggest that there is any very definite difference in volume or intensity between the two.

When we come to the buntings the position is much more obscure and one hesitates to say whether sub-song is present or not. We have a record of the Yellowhammer (*Emberiza citrinella*) which suggests that the early incomplete song contains lower frequencies than does the true song, and similarly has a greater frequency range. The Corn Bunting (*E. calandra*) also shows a tendency to have a sub-song of lower pitch and volume which in addition displays some slight differences in pattern (Figs. 13 and 14, plate 73).

In the B.B.C. collection is a recording (Fig. 16, plate 74) of the Scottish Crossbill (*Loxia pytyopsittacus scotica*), Inverness-shire, May 1957, which is labelled "sub-song", but we have no reliable recording of the full song of this sub-species with which to compare it. There is, however, a good recording of the full song of the Crossbill (*L. c. curvirostra*) from Suffolk, March 1953, (Fig. 15, plate 73) and if *The Handbook of British Birds* is correct in stating that the full songs of these two birds are indistinguishable, then we can say that the Inverness-shire record of *scoticus* (Fig. 17, plate 74) does show in several respects the characteristics which we should expect of a sub-song. Thus the main frequencies are lower, there is a distinct difference in pattern, and the song bursts are longer.

Finally, the Dunnock (*Prunella modularis*) (Figs. 18 and 19, plate 74) is the subject of a record made in Kent in March 1954, in which differences of frequency-range, volume and pattern all seem to be clear and which we may provisionally regard as genuine sub-song.

It is clear that this preliminary survey has served to do little

more than provide some suggestions as to what may prove to be a very interesting and profitable line of investigation both for the aviculturist and the field naturalist equipped with a good tape recorder. It is with the hope that others will find this a very promising subject of research that we publish this short article.

#### SUMMARY

Sub-song is defined as differing from full song in being: (1) quiet, (2) of a different pattern, (3) with song bursts longer, and (4) the notes of lower fundamental frequency. Also (5) the frequency-range of the notes in the sub-song tends to be greater (i.e. the notes are less pure in tone and less definite in pitch). Finally (6) the sub-song is usually produced earlier in the breeding season when sexual motivation is lower, and in young birds at least sometimes (7) appears to be a form of "practice" for the production of the full song. Chaffinch, Blackbird and Song Thrush all have sub-songs which show evidence of having these seven characteristics. Other species having sub-songs with 4 or 5 of these characteristics are Mistle Thrush, Redwing, Canary, American Goldfinch and Dunnock. More doubtful examples of sub-song are found in Brambling, Yellowhammer, Corn Bunting and Crossbill.

#### REFERENCES

- ARMSTRONG, E. A. (1955): *The Wren*. London.  
 BARRINGTON, DAINES (1773): "Experiments and observations on the singing of birds". *Phil. Trans. Roy. Soc.*, 63: 249-91.  
 DARWIN, C. (1871): *The Descent of Man*. London.  
 LISTER, M. D. (1953): "Secondary song: a tentative classification". *Brit. Birds*, xlv: 139-43.  
 NICHOLSON, E. M. (1927): *How Birds Live*. London.  
 ——— (1931): *The Art of Bird Watching*. London.  
 ——— and KOCH, L. (1936): *Songs of Wild Birds*. London.  
 THORPE, W. H. (1955): "Comments on *The Bird Fanciers Delight* together with notes on imitation in the sub-song of the Chaffinch". *Ibis*, 97: 247-51.  
 ——— (1958): "The learning of song patterns by birds, with especial reference to the song of the Chaffinch". *Ibis*, 100: part 3.  
 TROWELL, B. (1957): "King Henry IV Recorder-Player". *The Galpin Society Journal*, 10: 83-4.  
 WHITE, GILBERT (1789): *The Natural History of Selborne*. London.

## INTELLIGENCE TESTS WITH TITS

By M. BROOKS-KING and H. G. HURRELL

(Plates 75-76)

THE SERIES OF TESTS carried out by the writers, with the object of studying the reactions of Blue Tits (*Parus caeruleus*) when faced with a problem, will have been made familiar to many people by H.G.H.'s film, parts of which were shown in the "Look" series of television broadcasts on 5th February 1958. The following is an account of the history of these tests.

#### MATCH-BOX TESTS

In 1941 M.B.-K. formed the idea of offering peanuts to tits in

Vertical scale = frequency in kilocycles per second. Horizontal scale = time in seconds. Numbers in brackets refer to B.B.C. Record Library.

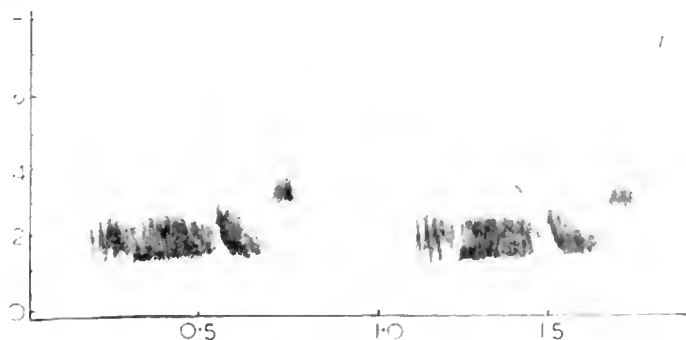

Fig. 1—Typical phrases from full song of Blackbird (*Turdus merula*): N. London, April 1957 (25025B). Phrases shown can be approximately rendered by the syllables *ill-cio*, *ill-ni*. Note fairly pure tone fundamental frequencies of the characteristic notes, restricted within a range of about 1.5 kc, with little sound above 2.5 kc. (page 512).

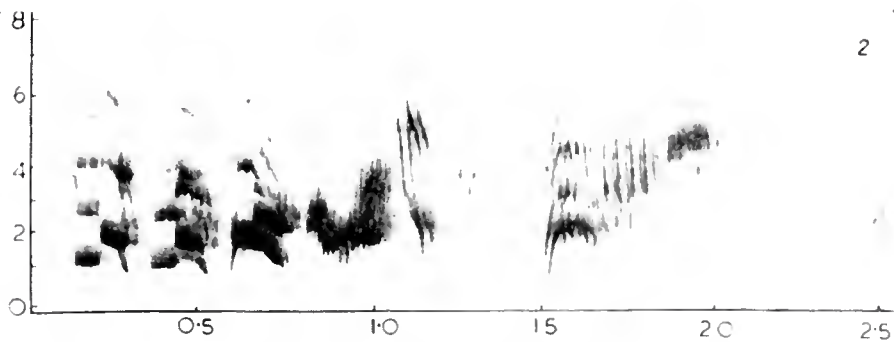

Fig. 2—Typical phrases from sub-song of Blackbird (*Turdus merula*): N. London, April 1957 (25025). Note very impure and therefore harsh-sounding notes as compared with Fig. 1, with fundamental frequencies ranging between 0.5 and 5.0 kc (i.e. both lower and higher than those of full song).

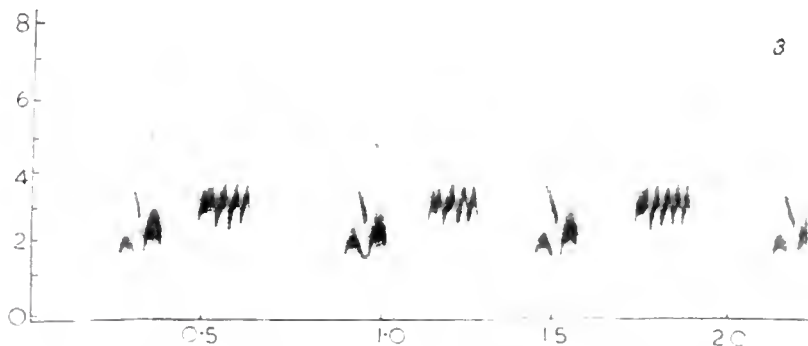

Fig. 3—Typical phrases from full song of Song Thrush (*Turdus philomelos*): Yorkshire, April 1956 (25025B). Phrases can be approximately rendered by the syllables *tu-ittee*, *tu-ittee*, *tu-ittee*. Note purity of tone. (page 512).

Vertical scale = frequency in kilocycles per second. Horizontal scale = time in seconds. Numbers in brackets refer to B.B.C. Record Library.

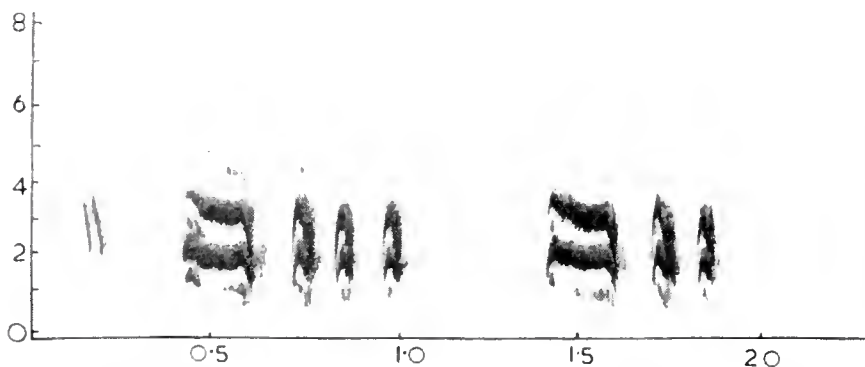

Fig. 4—Typical phrases from sub-song of Song Thrush (*Turdus philomelos*): Yorkshire, May 1954 (25025B). Note presence of lower frequencies and also greater range of frequencies as compared with the full song in Fig. 3.

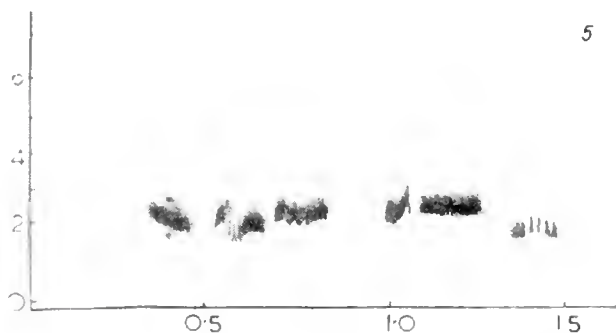

Fig. 5—Typical phrases from full song of Mistle Thrush (*Turdus viscivorus*): Kent, March 1954 (15135A). Note characteristically pure notes. (page 512).

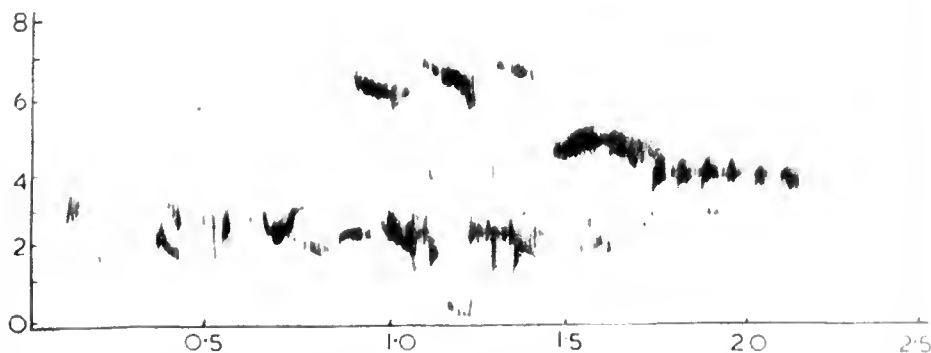

Fig. 6—Typical phrases from sub-song of Mistle Thrush (*Turdus viscivorus*): Kent, March 1954 (15134A). Note harsh impure notes with big frequency range and rambling ill-defined phrases.



Vertical scale = frequency in kilocycles per second. Horizontal scale = time in seconds. Numbers in brackets refer to B.B.C. Record Library.

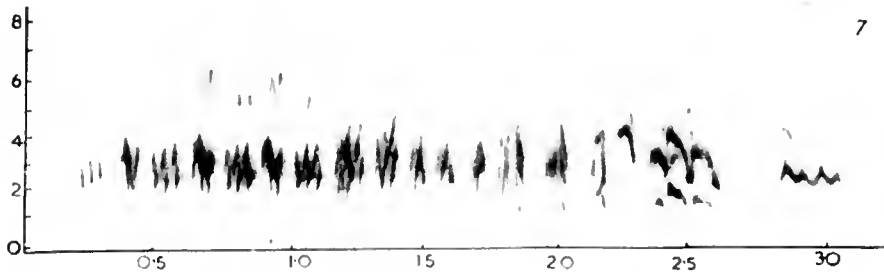

Fig. 7—Typical phrases from full song of Redwing (*Turdus musicus*): Thingvallatv, Iceland, June 1953 (15093). (page 512).

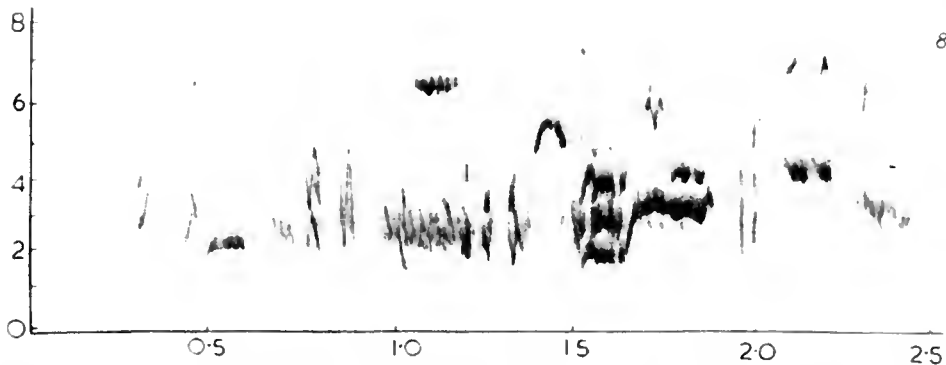

Fig. 8—Typical phrases from sub-song of Redwing (*Turdus musicus*): Kent, March 1954 (15134A). Note big frequency range and phrases less well defined than those in Fig. 7.

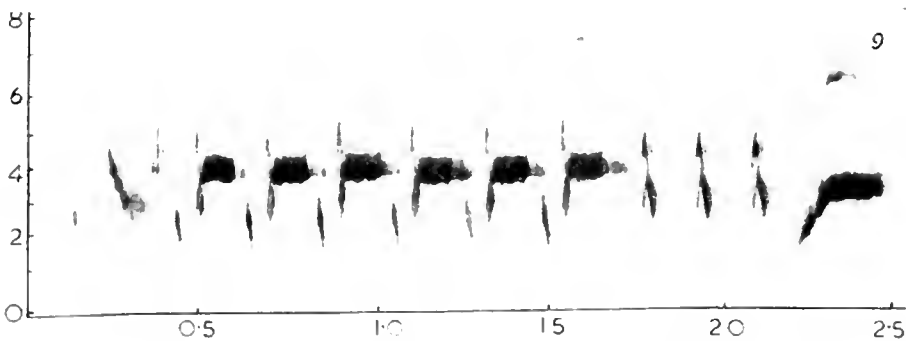

Fig. 9—Typical phrases from full song of Canary (*Serinus c. canarius*) (15030). Note purity of notes. (page 513).

Vertical scale = frequency in kilocycles per second. Horizontal scale = time in seconds. Numbers in brackets refer to B.B.C. Record Library.

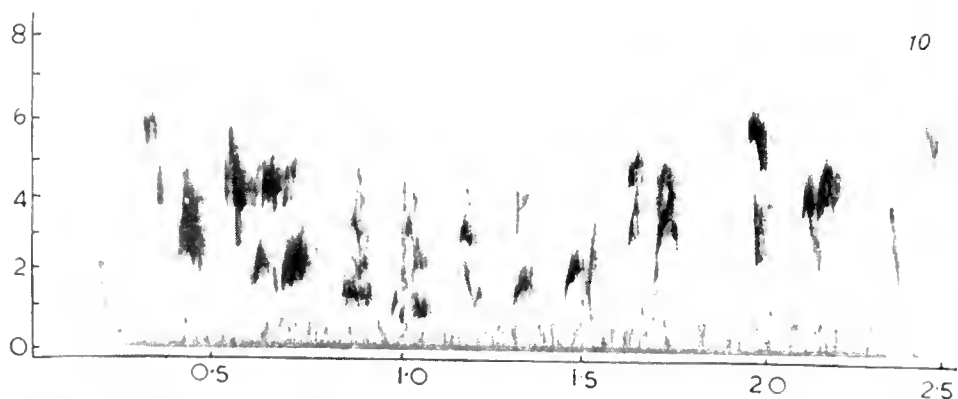

Fig. 10—Typical phrases from juvenile song of Canary (*Serinus c. canarius*), Madingley, Cambridge, July 1954. Note impurity of notes, containing much lower frequencies than those in Fig. 9.

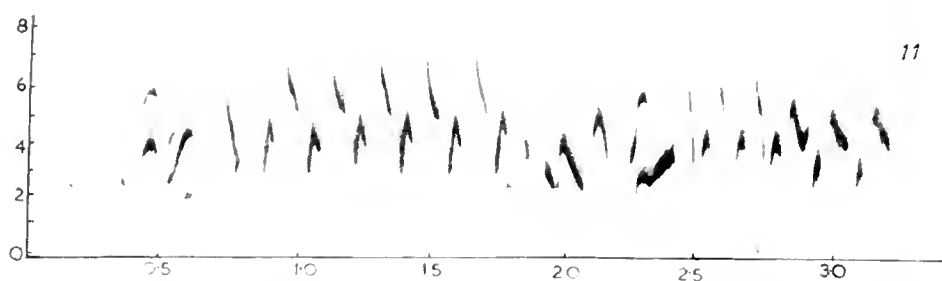

Fig. 11—Typical phrases from full song of American Goldfinch (*Spinus tristis*); Steward Peak, Ithaca, New York (Cornell recording). (page 513).

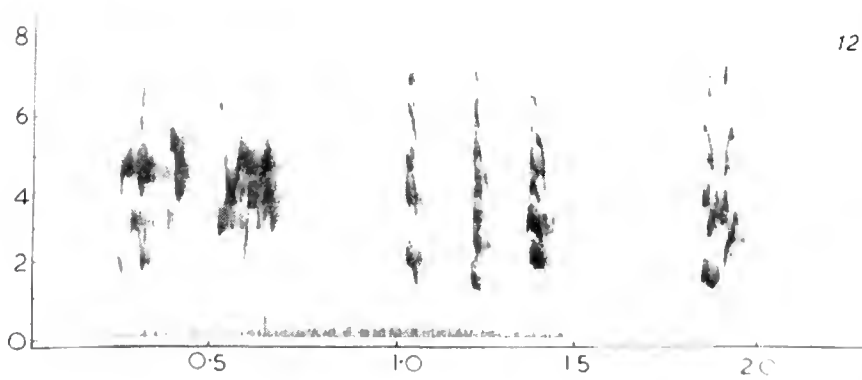

Fig. 12—Typical phrases from song of young captive American Goldfinch (*Spinus tristis*); Varna, New York, August 1952 (Cornell recording). Note that sound energy in the notes is spread fairly randomly over about 7 kc., compared with about 3 kc. in the full song in Fig. 11.

Vertical scale = frequency in kilocycles per second. Horizontal scale = time in seconds. Numbers in brackets refer to B.B.C. Record Library.

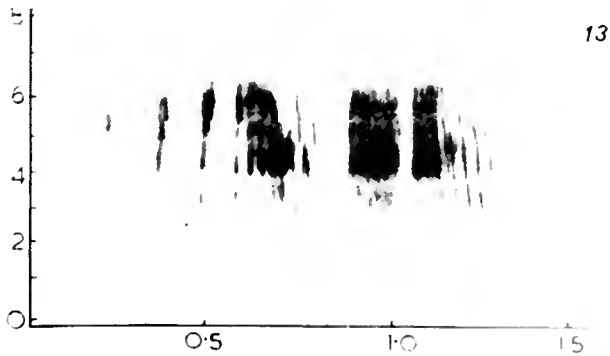

Fig. 13—Song of adult hand-reared Corn Bunting (*Emberiza calandra*): Madingley, Cambridge, May 1954 (W.H.T. Disc 120). This consists of a single short phrase of clicking and jangling notes, which is completely innate. (page 513).

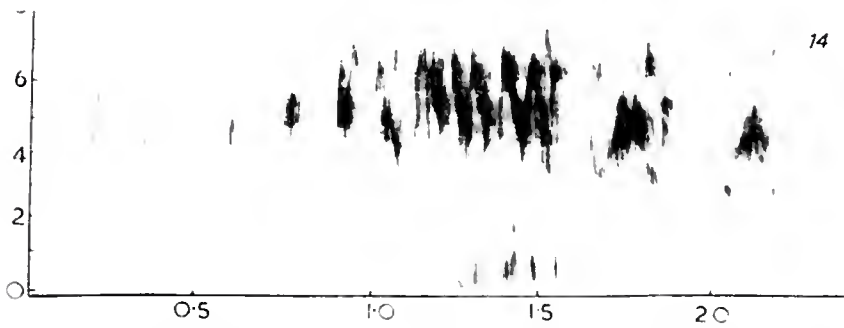

Fig. 14—Probable sub-song of hand-reared Corn Bunting (*Emberiza calandra*): Madingley, Cambridge, November 1952 (W.H.T. Disc 50). Note longer sequence with bigger frequency range than song in Fig. 13.

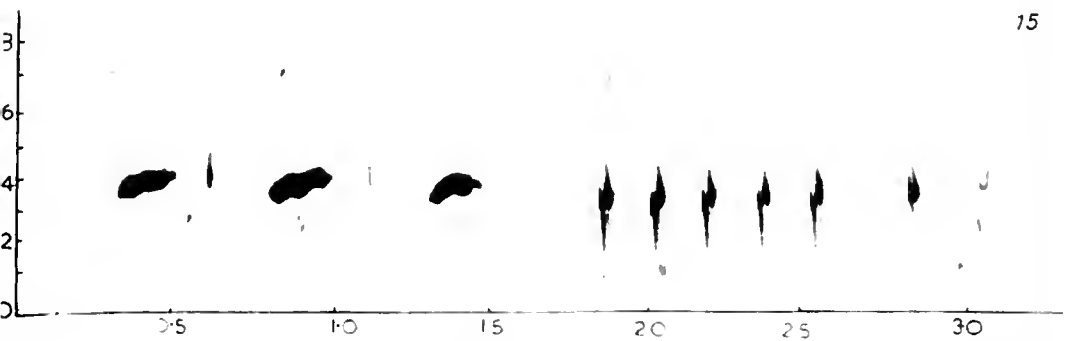

Fig. 15—Typical notes from full song of Crossbill (*Loxia c. curvirostra*): Suffolk, March 1953 (1522B). (page 513).

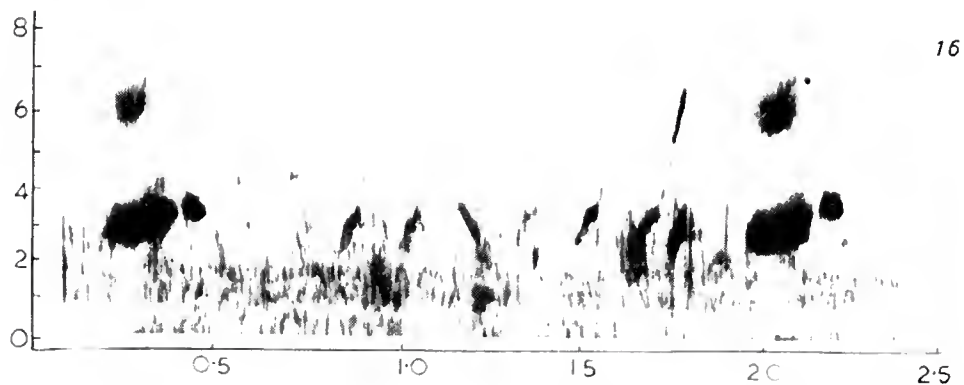

Fig. 16—Typical notes and phrases from sub-song of Scottish Crossbill (*Loxia pytyopsittacus scotica*): Inverness-shire, May 1957 (25031A).

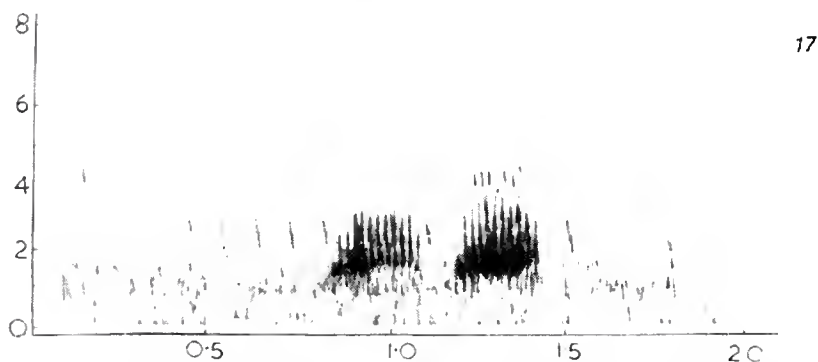

Fig. 17—Churring notes from sub-song of Scottish Crossbill (*Loxia pytyopsittacus scotica*): Inverness-shire, May 1957 (25031A).

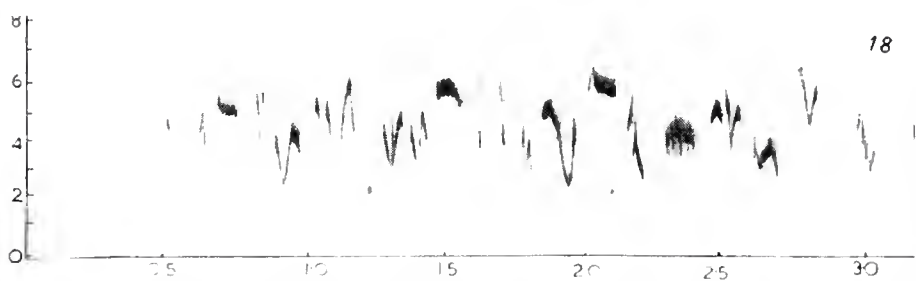

Fig. 18—Phrase from full song of Dunnock (*Prunella modularis*): Hampshire, May 1957 (15032A). (page 513).

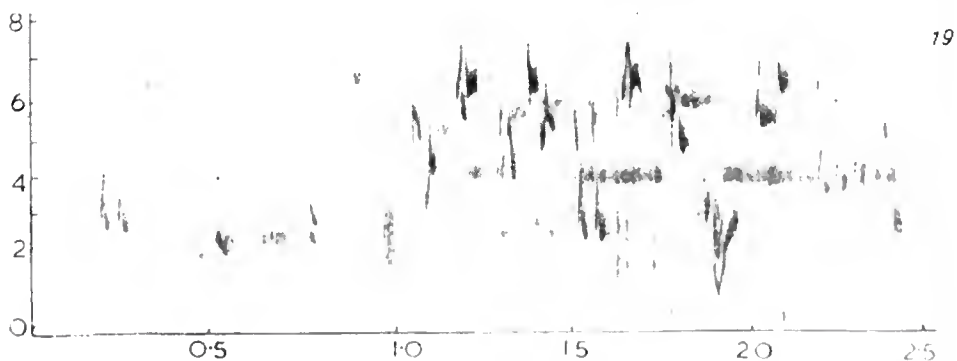

Fig. 19—Phrase from sub-song of Dunnock (*Prunella modularis*): Kent, March 1951 (15134B). Obviously similar to song in Fig. 18, but fundamental range greater and phrasing much less well defined.



*Peter Blomfield*

BLUE TIT (*Parus caeruleus*) REMOVING STICK FROM "PERSPEX" APPARATUS. This illustrates the "perspex" apparatus used in intelligence tests with tits at Wrangaton, Devon, and described on pages 520-523. Two sheets of perspex are held vertically by the frame and peanuts are supported on matchsticks inserted through the holes. The bird has to pull out the sticks to drop the nuts into the tray below.



Brian Pratt

COAL TIT (*Parus ater*) ABOUT TO OPERATE THE "PERSPEX" APPARATUS. Blue and Coal Tits were the only two species to solve this test. Here the bird is using the central perch to reach the top row of matchsticks and a peanut can be seen through the perspex on a level with its bill. In this test it was usual to set four nuts at a time and to have five successive rows of sticks for removal (see page 521).

“puzzle-boxes”, from which the nut could not be extracted without a correct solution of the problem. Three such puzzle-boxes were devised, and the results of those tests were recorded in *British Birds* later that year (vol. xxxv, pp. 29-32).

In 1955 a new series was started at Paignton, Devon, by the same experimenter, beginning with the third test of the former series. A sketch of the apparatus is shown in Fig. 1. The nut was placed in a match box the case being glued to a stout card back, which in turn was pinned to the frame of the window. A second box below acted as a tray to catch the nut when it fell. When the box was tapped down by the bird from above, the nut fell through an opening formed where part of the cover had been cut away. Inside the box a piece of card was so bent as to close the opening when the box was shut, but to guide the nut forward through it when it was opened. The reactions of various birds to this test were most interesting. In 1941 one male Great Tit (*P. major*) alone discovered the correct action; the other birds tried to excavate the nut from the front. In 1955 one Blue Tit (a female, as afterwards appeared) was successful almost from the first attempt, while its mate, which joined in later, took three months to achieve a correct solution. Successful exponents never “went back” after once achieving success; even a break of eight weeks during the summer holidays was not sufficient to rob them of the memory of how it was done. They also appeared to understand what they were doing, for after giving a few taps at the top of the box, they would look down into the tray to see if the nut had dropped, continuing with the tapping if it had not.

After a time this puzzle-box was replaced by others, each requiring a different technique for its solution. The second test, in which the box was opened by the lowering of a hinged perch fixed to it, was soon discarded, and is not figured among the illustrations.

Test 3, shown in Fig. 2, had the case fixed vertically as before; the upper half of the cover was cut off and then hinged by its lower edge, and provided with a small weight so that it fell open when pulled. The top of the case was closed by a piece of card, a small fold of which formed a catch to hold the door in position. A perch was provided for the bird, and the nut was placed on a shelf inside the box at a convenient level. Though at first the birds tried to tap the box down, when this proved unsuccessful it was not long before they solved the problem correctly, pulling the door open by the weight.

In Test 4 the box was fixed horizontally and the bird had to slide it open by pulling at the drawer. The arrangement for this test appears in part of Fig. 4 (A, B), though a piece of the cover was not, in this case, cut away. (The corrugated platform at D was a refinement to help the bird to get a good grip during the somewhat difficult process of dragging the box out.)

Test 5 introduced discrimination into the solution. The entire

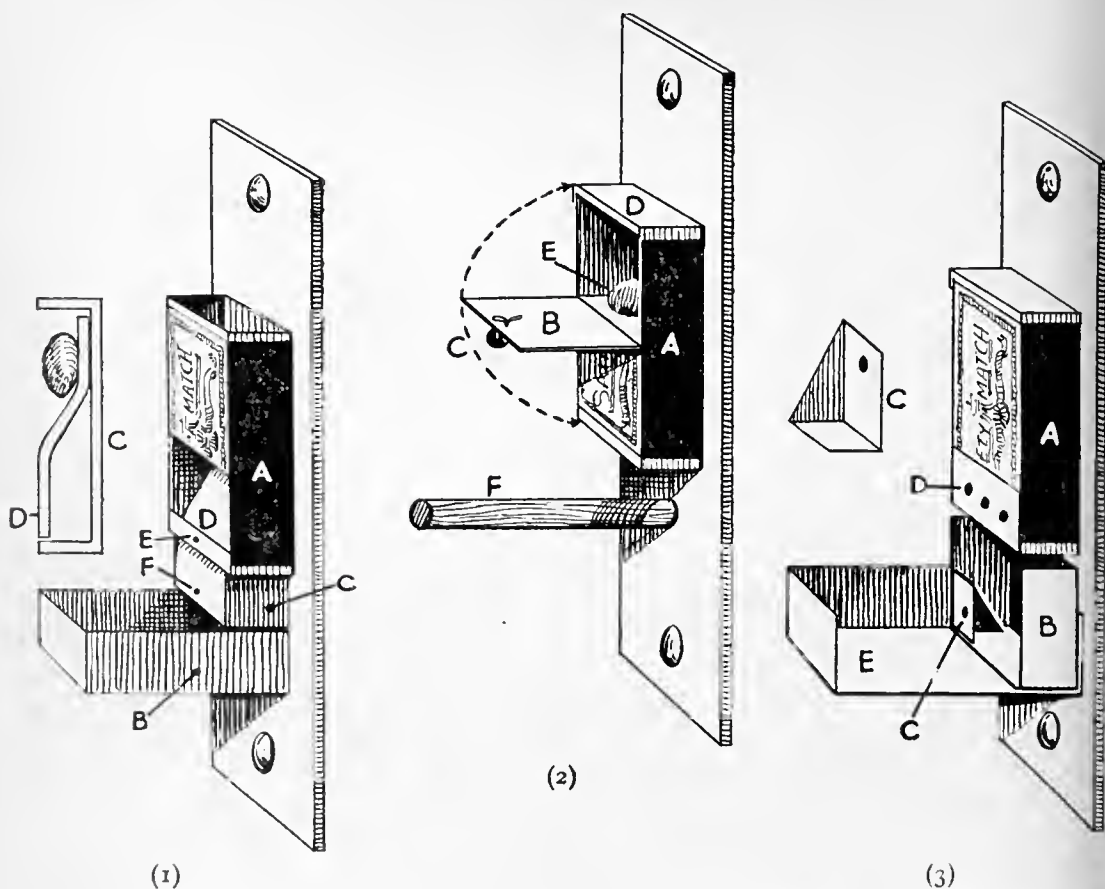

THREE TYPES OF MATCHBOX APPARATUS USED IN INTELLIGENCE TESTS WITH TITS

In each a matchbox case (A) is glued to a stout card that can be pinned up (matchbox size shows scale).

FIG. 1 (Tests 1 and 7)—Part of the front is cut away to let the peanut fall into the matchbox drawer (B) when the bird taps down the inner box (C) from the top. C consists of another drawer and a piece of bent card (D) which closes the opening when the apparatus is set. For Test 7 only, a matchstick was inserted through corresponding holes in the case and inner box (E, F): the bird then had to remove this first.

FIG. 2 (Test 3)—The upper half of the front (B) is cut and hinged, and is weighted (C) so that it drops open when released. A top (D) is fixed on the box: this has a small fold along its front edge to hold the door shut until the bird pulls at the weight and so exposes the nut on a shelf (E). There being no tray to stand on, a perch (F) is added.

FIG. 3 (Tests 5 and 6)—A matchbox drawer (B) is cut to half-length, weighted and made to move easily in its case (which again has a top). It is provided with a socket (C), so that a matchstick through a hole (D) in the case locks the drawer until pulled out, whereupon B falls into the tray (E) and the nut is exposed. Other holes level with D are dummies so that the tit can be confronted with 3 sticks (the area of the holes is best strengthened by gluing on a piece of card).

(Drawn by E. A. Tomsett from sketches by the authors)

match-box case was used this time, and for strengthening it a piece of card was glued across the lower end; holes were punched through this as shown in Fig. 3. The match-box drawer was cut down to rather less than half its length, and made to move very easily in the case (in fact, to ensure that it fell when released,



a small weight such as a brass nut was fixed inside). It was provided with a socket, as shown, through which a piece of match-stick pushed through a hole of the cover would pass, and thus lock the box till it was withdrawn. Two other match-sticks were glued into the other holes. The object of this test was to discover whether the birds would recognise which was the operative pin, and disregard the others. This, in fact, the original female Blue Tit did during the first day the test was put out, and she thereafter ignored the dummies, pulling out the correct one immediately on arriving at the box. Her mate was again not successful for a long time.

Test 6 was a development of the last. In this all three pegs were free to be pulled out, but only one of them locked the box. Three drawers were used, each with its socket opposite to a different hole in the case. The operative peg was painted blue, the idea to test the bird's ability to recognise this peg among the others, and to pull it out alone whenever it appeared. Though about 50% of recorded visits were successful at the first attempt, M.B.-K. hesitates to say that there actually was recognition, as all three pegs could be pulled out in as many seconds, so there was little inducement to learn which was the correct one. When released, the weighted drawer dropped with a thud on to the base, but the noise and vibration did not upset the bird in the least.

Test 7 had a two-stage solution, as can be seen by referring to Fig. 1 once more. A match-stick was passed through the holes E and F, so locking the box. At first the bird (for some time only the hen Blue Tit was able to do this trick) tapped fruitlessly at the top of the box. After a time, however, it discovered the match-stick protruding from the lower end of the case. Here training came into use. The extrication of the match-stick had been successful in the last two tests, so was worth a trial now! The stick was pulled out; but the box did not fall. However, the bird soon returned to the top of the box, and tapped it down in the usual way. Subsequently, the bird always removed the peg immediately it arrived, a further example of understanding of the procedure once it had been learnt.

Test 8 involved an entirely different action. A cut-down drawer, such as was used in Test 6, had a string attached which projected over the top of the case, and this had to be pulled up out of the case by the bird to obtain the nut. This test presented no difficulty whatever to the birds and they solved it at the first attempt.

At this time M.B.-K. had suggested to H.G.H. that an interesting film might be made of the tits solving the puzzles and one very successful session was held. When it was decided to add some more shots, M.B.-K. evolved a new test to be presented to the birds for the first time during actual filming. The apparatus, shown in Fig. 4, was a combination of Tests 4 and 7, involving three separate actions for its solution. It was hastily constructed,

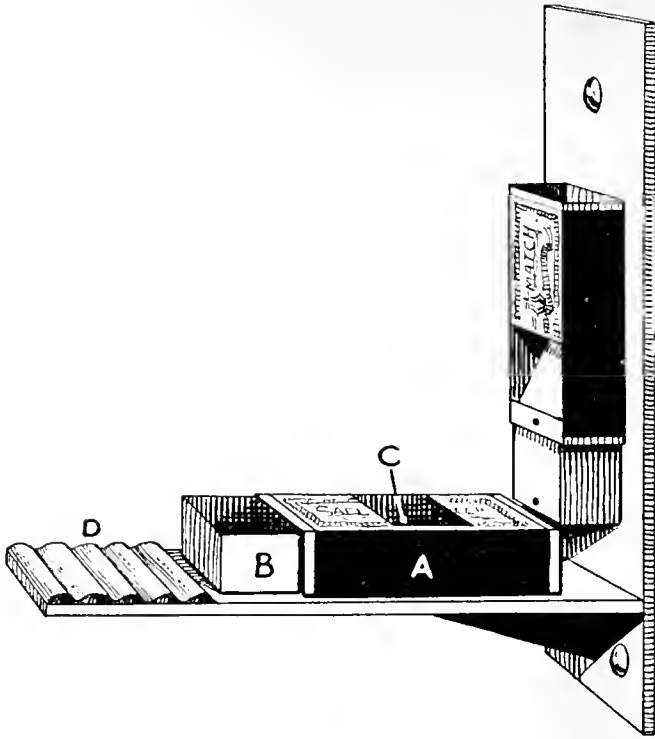

FIG. 4—THE FINAL THREE-STAGE MATCHBOX APPARATUS .

This shows Tests 4 and 9. In Test 4 a matchbox (A) is fixed horizontally and the bird has to pull open the drawer (B): for this there is no opening (C) in the cover of the box. C forms part of the three-stage Test 9, which is a combination of Tests 4 and 7 (Fig. 1): the bird has to remove a locking matchstick, tap down the drawer in the upper box so that the nut falls through the hole C in the lower one, and then pull open B. Flaps round C are essential (but not illustrated) to guide the nut and to stop the bird taking it out direct.

The corrugated platform (D) gives added grip.

(Drawn by E. A. Tomsett from a sketch by the authors)

and did not work very well (as may be seen in the films taken of it). However, the birds made light work of the complications, usually opening the lower box on arrival, and then going through the actions of Test 7, so that the nut dropped into the lower box, whence it was taken.

Only four other cases have been reported to us of match-box tests of these kinds being solved: mostly results of the television programme, these were at Chelmsford, Essex (D. R. Robinson); at Manchester (P. M. Grimshaw); at Chester (D. T. Dickenson); and at Plympton, Devon (*per* V. Almy). In these cases success was rapid. We have reason to think, however, that there have been many instances where the tits have failed and have soon lost interest: match-box tests at H.G.H.'s house at Wrangaton, for example, were not solved—not even the “easy” Test 8!

#### PULL-UP TESTS

Some entirely different tests were tried by H.G.H. at his home at Wrangaton, Devon. The well-known pull-up test, in which

a nut is suspended from a perch by means of a piece of thread, was solved by several Blue Tits. A development of this test, which involved pulling a truck up an incline to bring it near enough to the side of a cage for the tit outside to reach a reward, was only successfully operated by one Blue Tit, the tail-less "Shorty". The apparatus was loaned to a friend who had at least

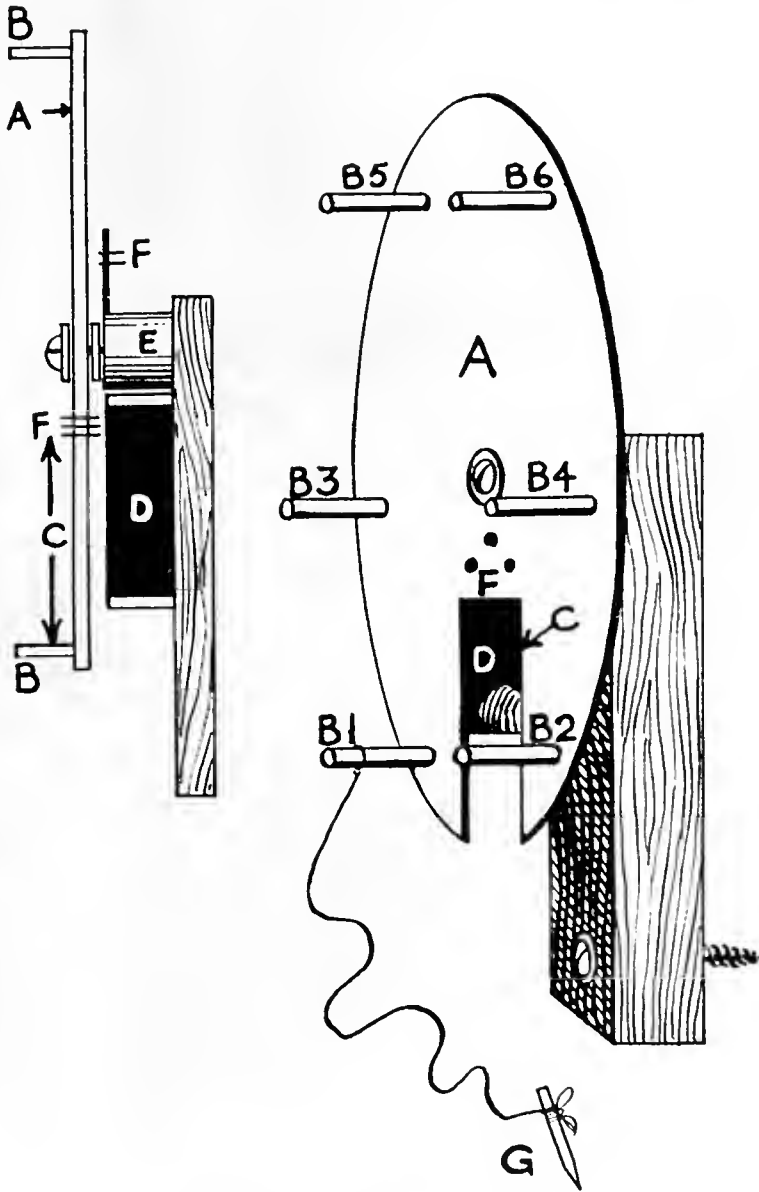

FIG. 5—THE "REVOLVING DISC" APPARATUS

A stout card disc (A), 6" in diameter, with six peripheral perches (B1-B6) is fixed upright so that it can revolve. Part (C) is cut away and, when a bird perches on B1 or B2 and its weight brings the gap down, it exposes a nut in a cut-away matchbox (D) glued behind: a wooden block (E) holds the disc far enough forward to allow room for D. Complications include matchsticks passed through holes in the disc and through, or to one side of, a card above E behind (F, F)—thus either locking the gap at the top or restricting rotation to one direction—and an anchoring pin (G) (see text).

(Drawn by E. A. Tomsett from a sketch by the authors)

a dozen Blue Tits coming fearlessly to his garden and bird table near Ugborough (his house being about two miles from H.G.H.'s), but they made no attempt to pull the string and soon lost interest.

#### THE "REVOLVING DISC" TEST

M.B.-K. arranged one further test, involving an entirely different action from those used with the match boxes. The apparatus is shown in Fig. 5. A circular disc of stout card, diameter 6", was fixed in an upright position, being free to rotate about its centre. Around the periphery were fixed short sticks acting as perches. A portion of the disc was cut away, allowing access to a nut contained in a match box behind. Tests were started with the box open, so the birds would learn where to expect to find the nut. Then the disc was rotated some way in either direction, so that it was necessary for a bird to turn it by alighting on one of the perches. This was a decided puzzler at first, many visits being made without success. But once a chance landing on either B<sub>1</sub> or B<sub>2</sub> turned the disc to the open position, the action was afterwards performed as a matter of course, though it did take the birds a little time to get used to the "long ride" from the top to the bottom. Complications were added as follows:—

- (i) A stop pin was passed through one of the side holes at F, so that the disc could rotate in one direction only; this pin was fixed tight.
- (ii) A pin was similarly passed through the centre hole at F, but loosely enough to be pulled out, though it locked the disc till it was removed.
- (iii) A pin, attached to one of the revolving perches by a length of string, was "plugged in" to the window frame some four or five inches to the side of the disc, thus also locking the apparatus until it was removed.

All these complications were successfully negotiated, and in M.B.-K.'s opinion the recognition of the association of the pegs some distance from the apparatus with its failure to turn was one of the outstanding achievements of these remarkable birds.

#### THE "PERSPEX" TEST

H.G.H. was then fortunate in being able to observe and record a new test, which was given a thorough trial on his bird-table. It was designed by S. Whittingham and constructed by V. Almy, and consisted of two vertical sheets of perspex held  $\frac{1}{2}$ " apart in a suitable frame. Several horizontal lines of holes were bored through both sheets so that pairs of match sticks inserted through the holes would support nuts. The tits had to pull out one or other of the sticks to drop the nut to the layer below and finally into the tray at the bottom where it became available. Once a tit had succeeded with a single drop, the test was subsequently set in such a way as to need up to five drops to successive layers of

match sticks to get the nut. It was found convenient to set a row of four nuts for each test with the apparatus. It was planned to set a series of 30 of these "perspex" tests, with every one watched and recorded. It was necessary, before the tests started, to allow the bird to get familiar with the strange piece of apparatus by leaving it unset on the bird-table for two or three days. It was tempting to try to catch and colour-ring as many birds as possible before the tests began, but experience has shown that this often makes them nervous, which is obviously most undesirable. Fortunately, the four different species involved could

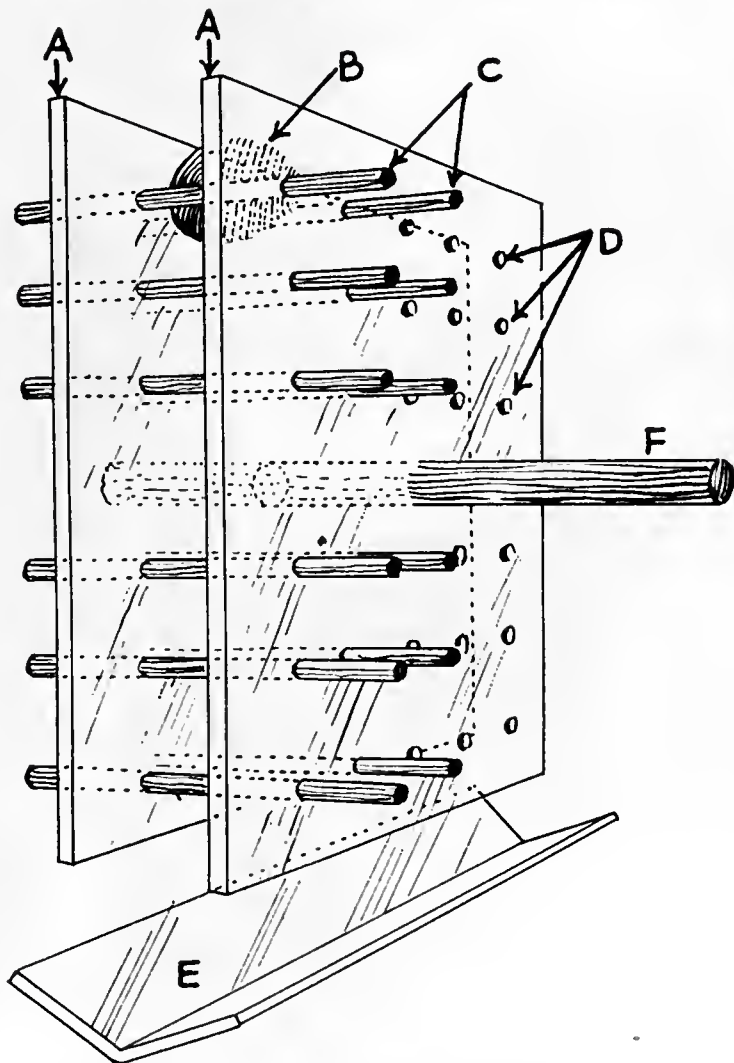

FIG. 6—THE "PERSPEX" APPARATUS

Two sheets of perspex (A) are fixed vertically,  $\frac{1}{2}$ " apart, in a suitable frame (see plate 75). A peanut (B) is supported on a pair of matchsticks (C) inserted through holes (D) in the perspex sheets. The bird has to pull out one of the matchsticks to drop the nut into the tray (E). With matchsticks in successive rows it is possible to make the bird repeat the effort several times before getting the nut which can, of course, be seen through the perspex. A central perch (F) is inserted for the top rows (see plates 76).

(Drawn by E. A. Tomsett from a sketch by the authors)

instantly be identified. The 30 tests covered a period of 23 days from 19th February 1958. Up to 26th February they were given once per day, but from the 27th onwards often twice a day (morning and evening). The photographs (plates 75 and 76) were taken on 8th March. The first test of the "perspex" series required the removal of only one match stick. Blue Tits soon showed interest, and, after a few pecks at random, one of them pulled out a match

TABLE I—THE RESULTS OF 30 "PERSPEX" TESTS WITH FOUR SPECIES OF TITS  
The apparatus is shown in Fig. 6. Four nuts were set in every test and the figures under each species indicate the number of nuts "dropped" and removed by that species in the course of the test. A † shows that the species was present on the bird-table at some time during the test, and the seven occasions on which Great Tits robbed Blue or Coal (see page 523) are marked with R.

Test number	Blue Tits ( <i>P. caeruleus</i> )	Coal Tits ( <i>P. ater</i> )	Great Tits ( <i>P. major</i> )	Marsh Tits ( <i>P. palustris</i> )
1	3	†	†	
2	2	†	†R	
3	2	†	†R	†
4	2	†	†R	
5	2	†	†	
6	2	†	†	
7	1	†	†	
8	2	†	†R	
9	2	1	†	
10	2	1	†	
11	1	†	†	
12	2	†	†	
13	1	1	†	
14	1	1	†	†
15	2	1	†	
16	2	2	†	
17	2	2	†	†
18	2	1	†	
19	2		†	
20	2	1	†R	
21	†	1	†	
22	2	†	†R	†
23	2		†	
24	2	1	†	†
25	3		†R	
26	3	†	†	†
27	3	1	†	
28	3	†	†	†
29	4	†	†	†
30	4	†	†	
Total nuts removed	63	14	0	0
Total times present	30	27	30	8

stick and carried off a nut. It was not long before a tit, which was doubtless the same one, returned and, with little delay, dropped another nut. At this stage several other Blue Tits visiting the table had not found the solution. Soon the initiated tit was back again and almost the moment it reached the bird-table, while still a foot or more from the apparatus, H.G.H. could see from its confident approach that it was the one which knew how to deal with the problem. Of the 30 tests which were carried out, Blue Tits succeeded in 29, being once anticipated by Coal Tits (*P. ater*). At 12 of the tests Coal Tits were successful: often a Coal Tit and, say, a couple of Blue Tits would deal with three of the four nuts which were always presented at each test.

The remarkable success of a Coal Tit which was completely uninitiated was especially noteworthy. This happened at the 9th test. On the 1st and 7th tests a Coal Tit had shown marked interest by closely inspecting the apparatus, but without result. On the 9th test a Coal Tit dropped a nut, without making a mistake, from the top to the bottom through five stages. It was an achievement so remarkable that one cannot help wondering whether imitation of the successful Blue Tits had played some part. As yet, however, we have failed to obtain any real proof of imitation being used in solving these problems. Coal Tits were successful at eleven subsequent tests. Marsh Tits (*P. palustris*) were present at the bird-table on eight occasions, but never even looked like attempting a solution. Nuthatches (*Sitta europaea*), too, sometimes visited the table, but never tried the pegs.

Great Tits were present at every test and showed keen interest in the nuts, constantly eyeing them with an obvious desire to reach them. They watched the Blue Tits intently and often tried to rob them as soon as a nut was dropped. On seven occasions they did in fact steal nuts in this way, even hovering over the Blue Tits as they pulled out the pegs. Not once did a Great Tit succeed in pulling out a peg, though they had every opportunity of doing so. They were quite at home and familiar with the presence of the apparatus and their interest was sustained, yet they seemed totally unable to get a nut by their own efforts. They were repeatedly able to watch the actions of the successful Blue and Coal Tits, but this did not seem to help.

#### DISCUSSION

It would be dangerous to make sweeping generalizations from the tests carried out so far, particularly as these observations have been made on only two populations of tits. But certain characteristics in the behaviour do seem indisputable. Above all, we have been intrigued by the varying ability of the birds in tackling the tests and the individuality they show: some solved the problems at once and yet others seemed to be permanently defeated. It has also been noteworthy that, though the discovery of the

correct solution may have been accidental, once learnt it has become firmly impressed on the bird and not forgotten through a period of weeks.

We have often been surprised by the keenness shown by certain birds in exploiting their successes. No doubt persistence is an important attribute in solving these tests and, clearly, much may depend on a bird's previous experience. When wild birds are being tested this is largely an unknown factor: for example, an instance was reported to M.B.-K. of Blue Tits pulling up caterpillars that were hanging from branches by threads, and this would stand such birds in good stead for pull-up tests.

The general aptitude of a species must always be borne in mind, both when devising tests and when assessing the results, particularly when comparing one species with another. The results of the "perspex" test seem to show that the Blue Tit and the Coal Tit have a much greater capacity for solving that type of problem than the Great Tit and the Marsh Tit, but we feel it would be unwise to generalize even from this at this stage.

It has been shown above, we hope, that a good deal of entertainment and also some valuable scientific data can be obtained with experiments on the lines we have described. More information is needed to assess the extent of variations in the capabilities and limitations of birds, both individually and between species. It is hoped, therefore, that other people will be able either to repeat these identical experiments or devise new ones and that they will keep a careful record of the results. In this way the amateur can contribute material which may be valuable in the study of bird psychology.

## NOTES

**Breeding of Black-tailed Godwits in the British Isles.**—The Council of the Royal Society for the Protection of Birds recently decided to announce the re-establishment of the Black-tailed Godwit (*Limosa limosa*) as a regular breeding bird in the British Isles in one area where one or more pairs have nested each year since 1952. This information has been withheld until now in the interests of the birds.

In the spring of 1952 three Black-tailed Godwits appeared in a locality which seemed suitable for breeding and on 11th May a nest with four eggs was found; by 22nd May, however, the birds had disappeared and this nest was found to be empty. Some weeks later a pair of godwits, presumably the same birds, were located at another marsh a few miles away and on 2nd July they clearly had young; in due course three young birds reached the free-flying stage.

In 1953 three pairs were located. One of these lost two clutches of eggs, the first possibly to Carrion Crows (*Corvus corone*) and



the second through having them trodden on by a cow; the nest of another pair also came to grief for reasons unknown. The third pair, however, successfully reared young.

In 1954 three pairs were again present and two were successful in hatching eggs: at least three young were reared to the flying stage.

In 1955 four pairs returned to breed and although two nests were lost, one probably due to Carrion Crows and the other to flooding, all four pairs were eventually successful in hatching eggs.

In 1956 no less than seven pairs arrived, but the season was disappointing and only three brought off young.

In 1957 there appeared to be a slight drop in the population and only six pairs were located. These, however, had a good year: only one nest failed and the birds concerned laid again, with the result that young were hatched by all six pairs.

In 1958 a successful season was again followed by an increase in the population and nine nesting pairs were located. Every one of these successfully reared young and so it now seems that the colony is firmly established. However, as is stressed in the account of these birds that appears in the current number of the R.S.P.B. magazine *Bird Notes* (vol. 28, pp. 415-416), "it is imperative that the birds should be given freedom from disturbance in any shape or form over the next few years" and so it is hoped that people will not attempt to visit the area.

The Black-tailed Godwit ceased to breed regularly in Britain about 1829 and in the next hundred years there were only some six inconclusive cases of nesting. During the last twenty years, however, there has been a remarkable increase in the numbers of Black-tailed Godwits on passage through Britain and wintering here—as was shown by Averil Morley and K. L. H. Price in *British Birds* in 1956 (vol. xlix, pp. 258-267)—and since 1937 there have been several isolated instances of birds nesting in various areas. It is to be hoped, therefore, that this one case of established breeding will spread and if anybody has reason to believe that a pair of godwits may be going to nest we hope they will contact the R.S.P.B. or ourselves without delay.

In conclusion, we should like to express appreciation of the work done by the R.S.P.B. in following up their success with the Avocets (*Recurvirostra avocetta*) by safeguarding and thus building up this first small colony of Black-tailed Godwits.

THE EDITORS

**The winter status of the Greenshank in west Wales.**—Of the Greenshank (*Tringa nebularia*) in winter, *The Handbook* gives simply: "Fairly often recorded winter (usually single birds) many parts England, Wales and Ireland . . .". In *A Handlist of the Birds of Carmarthenshire* (1954, p. 35) G. C. S. Ingram and H. M. Salmon list only six casual winter records (December-

February) for that county. In *The Birds of Pembrokeshire* (1949, p. 63) R. M. Lockley and the same two authors say vaguely: "Regular autumn and winter visitor, including the islands".

Perhaps the status of the Greenshank in Pembrokeshire during the winter months is changing. On the Gann estuary, near Dale, T.A.W.D. did not record any wintering Greenshank until one on 5th January 1937 and another seen often during the 1939-40 winter. Since observations became regular in 1945-46, after the war, however, they have wintered each year (see Table I). J.H.B. has also visited the Gann frequently during each winter from 1948-49 and during the first ten days in every January he has watched the Cleddau river from Hook to Llangwn, and Sandy Haven Pill. He has recorded Greenshank in most years from all these localities (see Table I).

TABLE I—RECORDS OF GREENSHANK (*Tringa nebularia*) WINTERING IN PEMBROKESHIRE, 1945-58

Winter	Gann estuary: no. resident		Cleddau and Sandy Haven no. resident		Possible total for 3 localities 1st- half January
	December/February T.A.W.D.	J.H.B.	1st-half January Cleddau	1st-half January Sandy Haven	
1945-46	1				
1946-47	1				
1947-48	1-2				
1948-49	3-4	1	0	1	4-5
1949-50	3-4	2-3	3	0	6-7
1950-51	3-4	5-8	1	0	6-9
1951-52	3-4	3	3	2-3	8-9
1952-53	5	ca. 5	3	3	11
1953-54	6+	3	6	3	15
1954-55	5	2	0	0	5
1955-56	3	1	10	2	13-15
1956-57	3-5	2-3	3	2	8-10
1957-58	3-5	4-7	2	3-5	10-14

Additional records are from the only three visits made during winter to the Cresswell river, where in January 1954, 1955 and 1958 there were 2-3, 1 and 2 Greenshank respectively. One bird was on Angle Bay during the only visit there, in January 1951. It seems probable also that during at least the last ten winters the Greenshank has been resident in small numbers in various parts of Milford Haven and there is evidence to show that the winter population may be increasing slowly. E. H. T. Bible (*antea*, vol. xxxvi, p. 182) described the regular wintering of a single bird in Merioneth for eleven seasons from 1932.

JOHN H. BARRETT and T. A. W. DAVIS

[This note is of general interest in that it emphasizes the tendency for certain waders, formerly regarded simply as passage-migrants, to be wintering in increasing numbers in the British Isles—as has been brought out by J. A. G. Barnes (*antea*, vol. xlix, pp. 167-171) *et al.* Apart from Greenshank, other examples are Black-tailed Godwit (*Limosa limosa*), Avocet (*Recurvirostra*

*avosetta*), Spotted Redshank (*T. erythropus*) and especially Ruff (*Philomachus pugnax*) (see *antea*, vol. L, p. 544).—EDS.]

**Broad-billed Sandpiper in Hampshire : correction.**—In the note on the Broad-billed Sandpiper (*Limicola falcinellus*) at Farlington Marshes, Hampshire, in October 1957, the dates were wrongly given as 12th and 13th (*antea*, p. 194). Mr. C. J. Henty informs us that the bird was in fact seen on 5th and 6th October 1957.

**Hoarding of food by Willow and Coal Tits.**—Further to my notes on food-hoarding by tits (*antea*, pp. 122-123), the following is a summary of additional observations made during the winter of 1957-58 and in the spring of 1958.

A Willow Tit (*Parus atricapillus*) was occasionally seen in my garden at West Wickham, Kent, during the summer of 1957 but did not visit the bird feeder until 9th October 1957. It called regularly after this, but no attempt was made to conceal any food from the feeder until 21st January 1958 when, during a very cold spell, peanuts (*Arachis hypogaea*) were removed and hidden in hedges, trees and plants. From that day the bird hoarded food regularly every morning.

On 19th February a second Willow Tit came to the feeder and immediately hid the first peanut it took in a dead delphinium stem some 4 feet away. The original Willow Tit watched from a distance of about 2 feet but made no attempt to interfere or remove the concealed peanut when the second bird returned to the feeding bowl. Now both birds hid food daily. Between 23rd February and 20th March 1958 a third Willow Tit called at the feeder but was not seen to hoard food. During April the original pair of birds continued to hoard food but not as frequently as in previous months. The last observation of hoarding occurred on 11th May, after which the birds ceased to call at the feeder at all.

When the birds started to hoard food during the 1957-58 winter they were content to take one peanut at a time and took a great deal of trouble to find suitable hiding places, but, possibly due to the competition of 2 Coal Tits (*P. ater*) which were also hiding food from the feeder, they began to take as many peanuts as they could carry in their bills, hiding them as quickly as possible. On occasions they were seen to drop all the peanuts at once into a fork or hole in a tree.

On 26th January 1958, when the first Willow Tit was about to conceal a nut in a clump of pinks, it was joined by a Coal Tit which watched from some three feet away. After inserting the peanut into the plant the Willow Tit chased the Coal Tit and tried to drive it from the garden, but the latter was successful in obtaining the peanut and taking it into the woodland at the rear of the house.

DAVID HART

[Mr. Hart tells us that a Willow Tit again started to hoard food on 30th November 1958 and was soon sufficiently tame to collect the peanuts from his hand.—EDS.]

## RECENT REPORTS AND NEWS

By I. J. FERGUSON-LEES and KENNETH WILLIAMSON

**The items here are largely unchecked reports, and must not be regarded as authenticated records. They are selected, on the present writers' judgment alone, from sources generally found to be reliable. Observers' names are usually omitted for reasons of space and in case a report is subsequently rejected, and none of the items will be mentioned in our annual Index. Readers are asked to submit anything of interest as quickly as possible.**

This summary follows on the one in the last number (*antea*, pp. 432-445) and covers the months of October and November.

### AMERICAN SPECIES FROM MID-OCTOBER

Pride of place must clearly go to the American Purple Gallinule (*Porphyryla martinica*) that was found on St. Mary's (Isles of Scilly) on 7th November: in poor condition, it died on the 9th and is now in the British Museum (Natural History). The species is found in the United States only as far north as Texas and South Carolina and so this bird was 1,500 miles north as well as 5,000 miles east of its normal range. In connection with such distances, however, it is interesting to recall that this gallinule is regularly drifted to Tristan da Cunha, 2,500 miles from the South American mainland (e.g. *Ibis*, vol. 99, pp. 579-580): like most of those that reach there, the one on St. Mary's was immature.

This was the third American species not at present on the British list to occur in a space of five weeks. In referring to the previous two (*antea*, p. 445) we briefly listed the other American species reported up to mid-October. Since that time there have been five further instances of American birds, apart from the gallinule. Three Snow Geese (*Anser caerulescens*) were seen at the Loch of Strathbeg (Aberdeenshire) on 22nd October and were still there in late November; while from 19th October until 2nd November there was a Blue Goose (the dark colour phase of the Lesser Snow, *A. c. caerulescens*) near Southport (Lancashire). Then on 29th October a Gray-cheeked Thrush (*Hylocichla minima*) was trapped on Fair Isle, the second there in five years (*cf. ante*a, vol. xlvii, pp. 266-267)—and it is an illuminating commentary on the effects of drift that the next rarity to appear on the island just eight days later, on 6th November, was an Asiatic species, White's Thrush (*Turdus dauma*), whose breeding range is some 8,000 miles from the other's! About this time, on 3rd November, an immature female Surf Scoter (*Melanitta perspicillata*) was first seen at North Bull (Dublin): still present on the 23rd, it was then accompanied by an immature male. The last American, more recently was a Killdeer (*Charadrius vociferus*) at Cley (Norfolk) in a high-tide roost of Ringed Plovers (*Ch. hiaticula*), on 1st December—the second consecutive December occurrence in Britain (*antea*, p. 398).

### SCANDINAVIAN AND EASTERN BIRDS

Another anniversary was marked by the arrival of a Pallas's Warbler (*Phylloscopus proregulus*) at Sandwich Bay (Kent) on

23rd November, just one year and six days after the Norfolk record of 1957 which was the third for the British Isles (*antea*, p. 197). It continued, however, to be a poor autumn for that other tiny Asiatic leaf-warbler, the Yellow-browed (*Ph. inornatus*), and we have heard of only three: Fair Isle, 10th-12th October; Spurn (Yorkshire), 29th October, and 25th and 27th November. Apart from the White's Thrush noted above, other eastern rarities have included Pechora Pipits (*Anthus gustavi*) at Fair Isle on 30th September (trapped) and 5th October (there have now been about a score of records of this Siberian pipit at Fair Isle and none elsewhere in western Europe!), and single Richard's Pipits (*A. novaeseelandiae*) at the same place on 4th and 14th October, and at Spurn from 27th November (trapped on 29th) to 1st December. Another Spurn occurrence of this end-November period was a Short-toed Lark (*Calandrella cinerea*) trapped on the 30th and still present on 7th December, and we have had preliminary details of a Greenish Warbler (*Phylloscopus trochiloides*) at Wisbech sewage-farm (Lincoln/Norfolk borders) on 23rd November (*cf. antea*, p. 434).

Other migrants at Fair Isle in early October included a Little Bunting (*Emberiza pusilla*), second of the autumn (*antea*, p. 434), on the 3rd; and three Bluethroats (*Cyanosylvia svecica*) and a Scandinavian Chiffchaff (*Phylloscopus collybita abietinus*) on the 5th. Later in the month, on the 23rd, two Siberian Chiffchaffs (*Ph. c. tristis*) were trapped there. Three Little Buntings were also identified at Shellness (Sheppey, Kent) on 12th October.

The eastern influence of the autumn continued to be demonstrated by Red-breasted Flycatchers (*Muscicapa parva*) and there were four further reports during October: St. Agnes (Isles of Scilly), 18th and 31st; Portland (Dorset), 19th; and Spurn (Yorkshire), 22nd. Finally, Fair Isle had its tenth of the autumn on 7th November. Only two Barred Warblers (*Sylvia nisoria*) were reported in October, however: at Spurn on the 5th and at Great Saltee (Co. Wexford) on the 10th. A Rose-coloured Starling (*Sturnus roseus*) at Sandown (Isle of Wight) on 18th October was the fifth of the autumn (*antea*, p. 434). A Black-headed Wagtail (*Motacilla flava feldegg*) arrived at Portland on 9th October, at the same time as other *flava* forms.

#### OTHER VAGRANTS

It is a curious fact that the Bridled Tern (*Sterna anaethetus*) seems unable to reach the British Isles alive! One was picked up dead on the tide-line at Sand Bay, near Weston-super-Mare (Somerset), on 17th October in just the same way as the only three previous British records (listed *antea*, pp. 303-304). Very much alive, on the other hand, were the usual sprinkling of Mediterranean Gulls (*Larus melanocephalus*), of which six were reported to us during October and November: the one at Hartle-

pool (Co. Durham) (*antea*, p. 363) was seen at intervals and seems established in the area; there was an adult at Rottingdean (Sussex) on 12th October and a sub-adult a few miles off Scarborough (Yorkshire) on the same day; then adults at Portland (Dorset) and Salthouse (Norfolk) on the 19th October and 30th November respectively; and, finally one reappeared near Lowestoft (Suffolk) on 30th November (*cf. antea*, p. 132).

A Little Bustard (*Otis tetrax*) was seen between North Frith and Hadlow, near Tonbridge (Kent), on 17th October. Spotted Crakes (*Porzana porzana*) occurred in the Chelmer Valley, near Chelmsford (Essex), on 11th October and at St. Leonard's (Sussex) on the 3rd; the latter was caught and released the following day at Pett Level.

A Great Snipe (*Capella media*) arrived on St. Agnes (Scilly) on 26th October.

An Alpine Swift (*Apus melba*) was an interesting companion of four late Swifts (*A. apus*) at Dunbar (East Lothian) on 11th October (see below). An Aquatic Warbler (*Acrocephalus paludicola*) at Great Saltee (Co. Wexford) on 2nd and 3rd October was the eleventh report of this species this autumn (*cf. antea*, pp. 362, 437), but two Crested Larks (*Galerida cristata*) at Dungeness (Kent) on 24th November are the only ones of which we have heard this year.

#### AVOCETS, SPOONBILLS AND OTHER REGULARS

Avocets (*Recurvirostra avosetta*) winter regularly on the Swale channel in Kent and on the Tamar estuary in Devon. We shall not therefore give details of reports from these areas, except that it is perhaps of interest to mention that the first three returned to the Tamar on 26th October (though there had been three on the Exe estuary on the 15th and 16th). A single Avocet was in the area of Bradwell and Foulness (Essex) for most of October, but of much greater interest was the influx in Hampshire in late November: 23 were seen at Dibden Bay on the 22nd and 23rd, dropping to two on the 24th and one on the 29th; on the 23rd, too, there were 35 in Langstone Harbour and over 50 flying east past Hayling Island. A single Avocet was seen at Pagham (Sussex) on 7th December.

Spoonbills (*Platalea leucorodia*) also winter regularly in Devon, on the Teign estuary, and the first was seen this autumn on 7th October, with a maximum of three since. An influx of Spoonbills at the beginning of October was referred to last month (*antea*, p. 444) and the following additional reports have been received: one immature, 4th October, Beaulieu river (Hampshire); five, 9th-10th October, Jersey (Channel Islands); and one immature, 15th October to at least 25th November, North Bull (Dublin). In addition, two were seen in the area of Christchurch (Hampshire) for some two or three weeks about the beginning of November.

The Sussex and Inverness Iceland Gulls (*Larus glaucoides*) (*antea*, p. 444) continued their stay and, apart from the former,

one at Lowestoft Ness (Suffolk) on 18th October was the only other one reported from the southern half of Britain. Another long-staying gull, the Cheshire Glaucous (*L. hyperboreus*) which alternates between Hilbre and West Kirby (*antea*, p. 317), was still present at the end of November—so that it has now been there for over 15 months!

#### LATE SWIFTS

In response to our appeal in the September number (*antea*, p. 366) we have received a number of reports of unusual movements of Swifts (*Apus apus*) in different parts of the country in the last ten days of August and early September. But of more concern here are the October observations of Swifts that have reached us. There were more stragglers than usual in the latter half of September and the first week of October, and then the following come within the range of late dates given in *The Handbook*:

- 8th October: 1 and later 3 at Alnwick (Northumberland); 3 at Monks' House (Northumberland); 3 near Hartlepool (Co. Durham).  
 9th October: 1, 3 and 1 at Alnwick; 1 flying S.S.W. at Hemel Hempstead (Hertfordshire).  
 10th October: 5 at Redcar (Yorkshire); 4 near Hartlepool.  
 11th October: 4 at Dunbar (East Lothian), accompanied by an Alpine Swift (see above).  
 12th October: 2 at Alnwick; 1 at Sheringham (Norfolk); 2 at Dungeness (Kent).  
 13th October: 1 at Alnwick; 1 at Overstrand (Norfolk).

The number of these occurrences and the coincidence in dates, as well as the association of the Alpine Swift, suggest that a quantity of Swifts may have been considerably off course at this time and so we feel that there are probably other records. We should be glad to receive details of any October Swifts.

#### OTHER LATE SUMMER-VISITORS

Apart from the Swifts, we have received a number of other reports of late summer-visitors. Swallows (*Hirundo rustica*), House Martins (*Delichon urbica*), Wheatears (*Oenanthe oenanthe*), Chiffchaffs (*Phylloscopus collybita*) and Willow Warblers (*Ph. trochilus*) are all species that to a greater or lesser extent are still on passage in November, but this year from widely scattered areas have come observations of later and larger movements. Apart from these, however, the later occurrences of other birds include a number that come within the range of late dates given in *The Handbook* and the following is a selection:

- Common Tern (*Sterna hirundo*): one, Southend (Essex), 1st November; one, St. Ives (Cornwall), 11th November.  
 Sandwich Tern (*Sterna sandvicensis*): one, Dungeness (Kent), 25th October.  
 Turtle Dove (*Streptopelia turtur*): one, Dungeness, 9th October; three, Dungeness, 10th October.  
 Nightjar (*Caprimulgus europaeus*): one, Dungeness, 14th October.  
 Sand Martin (*Riparia riparia*): several reports, 18th-24th October.  
 Whinchat (*Saxicola rubetra*): one, Dunstable (Bedfordshire), 12th October; last one at Dungeness, 28th October; male at Sandwich Bay (Kent), 6th November.

- Grasshopper Warbler (*Locustella naevia*): one, Pagham (Sussex), 3rd October; one, Dungeness, 9th October.
- Reed Warbler (*Acrocephalus scirpaceus*): one, Great Saltee (Co. Wexford), until 9th October.
- Sedge Warbler (*Acrocephalus schoenobaenus*): last one at Dungeness, 21st October.
- Garden Warbler (*Sylvia borin*): one, Dungeness, 2nd November; one, Fair Isle, 7th November.
- Whitethroat (*Sylvia communis*): one, near Eastbourne (Sussex), 16th November; one, at Ruxley, near Sidcup (Kent), 23rd to at least 30th November (injured wing).
- Lesser Whitethroat (*Sylvia curruca*): one, Dungeness, 22nd November (trapped, typical race).
- Pied Flycatcher (*Muscicapa hypoleuca*): one, Culver (Isle of Wight), 18th October.
- Yellow Wagtail (*Motacilla flava*): two *flavissima*, Blithfield reservoir (Staffordshire), 1st November; male still at Blithfield, 8th November.
- Red-backed Shrike (*Lanius cristatus*): immature, Frodsham (Cheshire), 25th October to 2nd November.

This list is doubtless incomplete, too, and we should be very glad to hear of any other summer-visitors which might rank as "late".

There have been several reports of Common Sandpipers (*Tringa hypoleucos*) in November, but this is normal now. Certain other passage waders—for example, Wood Sandpipers (*Tringa glareola*) and Whimbrel (*Numenius phaeopus*)—contributed to the November picture, and for Whimbrel this completed a remarkably heavy autumn passage that we have commented on previously (*antea*, p. 367). Black Terns (*Chlidonias niger*) were reported from various localities in October, the three latest observations being single birds at Eccleston Mere (Lancashire) on the 18th, and at Bardsey (Caernarvonshire) and Hanningfield (Essex) on the 19th.

#### LATE NESTS

Nests of Mallard (*Anas platyrhynchos*), Partridge (*Perdix perdix*), Song Thrush (*Turdus philomelos*), Blackbird (*T. merula*) and Starling (*Sturnus vulgaris*) were found in counties as far apart as Hampshire, Hertfordshire and Lancashire during October and November and we should be glad to have details of any others. Similar, and perhaps connected, are the several references we have received to an unusual outbreak of late October and early November song from such species as Song Thrush, Mistle Thrush (*T. viscivorus*), Skylark (*Alauda arvensis*) and even Blackbird.

The dictates of space prevent us from dealing more fully with this subject at the moment and from covering certain others of topical interest—thrush movements, Balearic Shearwaters (*Procellaria puffinus mauretanicus*), Crossbills (*Loxia curvirostra*), sea-birds inland, Little Auk (*Plautus alle*) movements, Firecrests (*Regulus ignicapillus*), a possible influx of Short-eared Owls (*Asio flammeus*), etc. However, we hope to be able to mention at least some of these a little more fully in our next issue. As always, we are deeply grateful to the many observers who continue to send us information.



## NOTICE TO CONTRIBUTORS

*British Birds* publishes material dealing with original observations on the birds of Britain and western Europe, or, where appropriate, on birds of this area as observed in other parts of their range. Except for records of rarities, papers and notes are normally accepted only on condition that the material is not being offered to any other journal. Photographs (glossy prints showing good contrast) and sketches are welcomed. Proofs of all contributions accepted are sent to authors before publication. After publication 20 separates of papers are sent free to authors; additional copies, for which a charge is made, can be provided if ordered when the proofs are returned.

Contributors are asked to observe the following points, attention to which saves the waste of much editorial time on trivial alterations:

1. Papers should be typewritten with double spacing, and on one side of the sheet only. Shorter contributions, if not typed, must be clearly written and with similar spacing. Failure to help in this way may result in delays to publication.

2. Notes should be worded as concisely as possible, and drawn up in the form in which they will be printed, with signature in block capitals and the writer's address clearly written on the same sheet. If more than one note is submitted, each should be on a separate sheet, with signature and address repeated. In the case of rarity records, any supporting description which is too detailed for publication should be attached separately.

3. Certain conventions of style and lay-out are essential to preserve the uniformity of any publication. Authors of papers in particular, especially of those containing Systematic Lists, Reference Lists, Tables, etc., should consult the ones in this issue as a guide to general presentation. English names of species should have capital initials for each word, except after a hyphen (e.g. Willow Warbler, Black-tailed Godwit), but group terms should not (e.g. warblers, godwits). English names are those used in *The Handbook of British Birds*, with the exception of the changes listed in *British Birds* in 1953 (vol. xlvii, pp. 2-3). The scientific name of each species should be given (in brackets and underlined) immediately after the first mention of the English name. Sub-specific names should not be used except where they are relevant to the discussion. It is sometimes more convenient to list scientific names in an appendix. Dates should take the form "1st January 1955" and no other, except in Tables where they may be abbreviated to "1st Jan.", "Jan. 1st", or even "Jan. 1", whichever most suits the lay-out of the Table concerned. It is particularly requested that authors should pay attention to Reference Lists, which otherwise cause much unnecessary work. These should take the following form:

TUCKER, B. W. (1949): "Species and subspecies: a review for general ornithologists". *Brit. Birds*, xlii: 129-134.

WITHERBY, H. F. (1894): *Forest Birds: Their Haunts and Habits*. London. p. 34.

Various other conventions concerning references, including their use in the text, should be noted by consulting previous examples.

4. Tables should be numbered with Roman numerals, and the title typed above in the style used in this issue. The title and any headings within the Table should not be underlined, because this sometimes makes it difficult for the Editor to indicate the type to be used. It is most important that the lay-out of each Table should be carefully planned with an eye to its final appearance; above all, it should be borne in mind that Tables must either fit into the width of a page, or be designed to fit a whole page lengthways. All Tables should be self-explanatory.

5. Figures should be numbered with Arabic numerals, and the captions typed on a separate sheet. All line-drawings should be in Indian ink on good quality drawing paper (not of an absorbent nature) or, where necessary, on graph paper, but this must be light blue or very pale grey. It is best if maps, graphs, etc., are drawn twice the size of the final reproduction (ideally, therefore, for the normal 4" width the original should be 8" wide); sketches of birds, however, should be only slightly larger than the size at which it is intended they should appear. It is always most important to consider how each drawing will fit into the page. The neat insertion of lettering, numbers, arrows, etc., is perhaps the most difficult part of Indian ink drawing and, unless he has had considerable experience of this kind of work, an author should seek the aid of a skilled draughtsman. The publishers regret that, owing to rising costs, it will in future be only in exceptional cases that they can undertake to have lettering inserted.



*Now Available*

# WITHERBY'S SOUND-GUIDE TO BRITISH BIRDS

by

MYLES NORTH and ERIC SIMMS

**Introduced by JAMES FISHER**

*PRODUCED WITH THE CO-OPERATION OF THE  
BRITISH BROADCASTING CORPORATION*

**195 species on 13 double-sided 10"  
gramophone records**

- RECORDINGS BY LUDWIG KOCH, ERIC SIMMS, RADIOTJÄNST, JOHN KIRBY, CARL WEISMANN, MYLES NORTH AND OTHERS.
- To be published simultaneously in two parts, each boxed and with descriptive book. £5, 10s. 0d. each part.

*PART ONE (Seven records):* Divers—Grebes—Petrels—Cormorants—Hérons—Ducks—Geese—Swans—Birds of Prey—Game Birds—Crakes—Waders—Skuas—Gulls—Terns—Auks—Doves—Owls—Woodpeckers—(includes also Cuckoo, Nightjar, Swift, Kingfisher, Bee-eater and Hoopoe).

*PART TWO (Six records):* Larks—Swallows—Crows—Tits—Thrushes—Chats—Redstarts—Warblers—Flycatchers—Pipits—Wagtails—Finches—Buntings—(includes also Golden Oriole, Nuthatch, Treecreeper, Wren, Nightingale, Robin, Goldcrest, Dunnock and Red-backed Shrike).

£5 10s. 0d. each part.

**Available post free from the publishers :**

**H. F. & G. WITHERBY LTD.,  
5 Warwick Court, London, W.C.1**

1 DEC 1957  
PURCHASED

## INDEX

Compiled by MRS. N. D. BLAMIRE



Entries are in a single list with references to:

(i) every *significant* mention of each species, not only in titles, but within the text of papers and notes, including all those appearing in such lists as the *Report on bird-ringing for 1957*; in such groups as "Warbler", "Thrush", "Duck", etc., there are cross-references to those members of the family which do not bear the family name and so appear elsewhere, e.g., "Blackcap", "Fieldfare", "Wigeon", etc.;

(ii) scientific nomenclature listed under generic names only;

(iii) authors of all papers, notes and letters; and photographers;

(iv) a few subject headings, i.e., "Breeding", "Display", "Field-characters", "Food", "Migration", "Obituaries", "Reports and news", "Requests for Information", "Voice";

(v) "Reviews" which are listed together under this heading in alphabetical order of authors reviewed.

*Accipiter gentilis*, see Goshawk.

— *nisus*, see Sparrowhawk.

*Acrocephalus arundinaceus*, see Warbler, Great Reed.

— *paludicola*, see Warbler, Aquatic.

— *palustris*, see Warbler, Marsh.

— *schoenobaenus*, see Warbler, Sedge.

— *scirpaceus*, see Warbler, Reed.

*Aegithalos caudatus*, see Tit, Long-tailed.

*Alauda arvensis*, see Skylark.

*Alca torda*, see Razorbill.

*Alcedo atthis*, see Kingfisher.

*Alectoris rufa*, see Partridge, Red-legged.

*Alle alle*, see Ank, Little.

Allen, R. H. and Rutter, G., The moult migration of the Shelduck from Cheshire in 1957, 272-4.

*Anas acuta*, see Pintail.

— *angustirostris*, see Duck, Marbled.

— *crecca*, see Teal.

— *penelope*, see Wigeon.

— *platyrhynchos*, see Mallard.

— *querquedula*, see Garganey.

— *strepera*, see Gadwall.

Andrew, D. G., Photographic studies of some less familiar birds: LXXXVIII, Capercaillie, 189-192, pl. 29-32.

Angles, R., Note on Great Skua harrying Shelduck, 121.

*Anser albifrons*, see Goose, White-fronted.

— *anser*, see Goose, Grey Lag.

*Anser arvensis brachyrhynchus*, see Goose, Pink-footed.

*Anthus campestris*, see Pipit, Tawny.

— *pratensis*, see Pipit, Meadow.

— *spinoletta*, see Pipit, Water.

— *spinoletta petrosus*, see Pipit, Rock.

— *trivialis*, see Pipit, Tree.

*Apus apus*, see Swift.

— *melba*, see Swift, Alpine.

*Aquila chrysaetos*, see Eagle, Golden.

— *heliaca*, see Eagle, Imperial.

*Ardea cinerea*, see Heron.

— *purpurea*, see Heron, Purple.

*Ardeola ibis*, see Egret, Cattle.

— *ralloides*, see Heron, Squacco.

*Arenaria interpres*, see Turnstone.

Armstrong, Edward A., Notes on the Wren in the Aran Islands, Ireland, 29-35.

Arthur, Reginald W., Note on Collared Flycatcher on Bardsey, 36.

Ash, J. S., Note on Partridges apparently affected by industrial contamination, 241-2.

*Asio flammeus*, see Owl, Short-eared.

— *otus*, see Owl, Long-eared.

*Athene noctua*, see Owl, Little.

AUK, LITTLE, in N. Atlantic, 98; status in Tiree and Coll, 104, 115; numbers ringed 1957, 456.

AUKS, see also Guillemot, Puffin, Razorbill.

AVOCET, habitat in Coto Doñana, 17-18; habitat in Camargue, 327, 329-32, 347, pl. 50.

- Axell, H. E., Note on Greenish Warbler in Kent, 125.  
*Aythya ferina*, see Pochard.  
 — *fuligula*, see Duck, Tufted.  
 — *marila*, see Scaup.  
 — *nyroca*, see Duck, Ferruginous.
- Bannerman, David A., Letter on the distribution of the Frigate Petrel, 447-8.
- Barrett, J. H. and Davis, T. A. W., Note on the winter status of the Greenshank in West Wales, 525-6.
- Barton, B. A. B., Note on Desert Wheatear in Essex, 275-6.
- BEE-EATER, habitat in Coto Doñana, 11, 17-18, 21; habitat in Camargue, 335.
- Bennett, C. G., Boyd, A. W. and Cusa, N. W., Note on Little Shearwater in Cheshire, 354.
- Betts, Monica M., The behaviour of adult tits towards other birds and mammals near the nest, 426-9.
- Billett, D. F. and Henty, C. J., Note on Broad-billed Sandpiper in Hampshire, 194.
- BITTERN, habitat in Coto Doñana, 17; habitat in Camargue, 339; numbers ringed 1957, 456; foreign-ringed recovery in Britain, 489.
- , LITTLE, habitat in Camargue, 339.
- BLACKBIRD, habitat in Coto Doñana, 8; foreign-ringed recoveries in Britain, 70, 495; status in Tiree and Coll, 107, 116; feeding juvenile Song Thrush, 309; abnormal growth on foot, 310; habitat in Camargue, 343; numbers ringed and recovered, 1957, 455, 479; sub-song, 512, pl. 69.
- BLACKCAP, habitat in Camargue, 335, 343, 347; numbers ringed and recovered 1957, 455, 481.
- BLUETAIL, RED-FLANKED, in Kent, 37.
- BLUETHROAT, at Portland Bill, 28; numbers ringed 1957, 456.
- Bombycilla garrulus*, see Waxwing.  
*Botaurus stellaris*, see Bittern.
- Bowers, J. K. and Jones, E. L., Note on Pratincole in Hampshire, 119.
- Boyd, A. W., Note on Spotted Crake in Cheshire in July, 78; "Information wanted on Lapwing chicks": note, 161.
- Boyd, A. W., see Bennett, C. G.  
 —, —, and Nicholson, E. M., Note on mating display of Snipe, 79-80.
- Boyd, J. Morton, The birds of Tiree and Coll, 41-56, 103-118, pl. 18-20.
- Boyle, G. L., Letter on "Science and the bird-watcher", 129.
- BRAMBLING, foreign-ringed recoveries in Britain, 72, 496; status in Tiree and Coll, 110, 117; numbers ringed and recovered 1957, 455, 487.
- Branta bernicla*, see Goose, Brent.  
 — *canadensis*, see Goose, Canada.  
 — *leucopsis*, see Goose, Barnacle.  
 — *ruficollis*, see Goose, Red-breasted.
- BREEDING: Wren, 29-35; Iceland Gyr Falcon, 285-90.  
 —; NESTS: Lesser Black-backed Gull, 399-401; Herring Gull, 399-401; Song Thrush, 275.
- Brooks-King, M. and Hurrell, H. G., Intelligence tests with tits, 514-524, pl. 75-76
- Browne, P. W. P., Note on the field-identification of Baird's and Semi-palmated Sandpipers, 81; a North Atlantic transect in September, 93-9.
- Bucephala clangula*, see Goldeneye.
- Bull, Arthur, Note on Glossy Ibis in Dorset, 118.
- BULLFINCH, status in Tiree and Coll, 110, 117; numbers ringed and recovered 1957, 455.
- BUNTING, CURL, numbers ringed 1957, 455.
- , CORN, status in Tiree and Coll, 110, 117; roosting in reeds, 126, 276; habitat in Camargue, 325, 335, 342, 347; numbers ringed and recovered 1957, 455; sub-song, 513, pl. 73.
- , LAPLAND, migration at Portland Bill, 29; in N. Atlantic, 98; body-size in relation to migration, 223-4.
- , LITTLE, numbers ringed 1957, 457.
- , ORTOLAN, at Portland Bill, 29; numbers ringed 1957, 457.
- , RED-HEADED, numbers ringed 1957, 457.
- , REED, status in Tiree and Coll, 110, 117; habitat in Camargue, 339; numbers ringed and recovered 1957, 455; foreign-ringed recovery in Britain, 496.

- Muscicapa hypoleuca*, see Flycatcher, Pied.  
 — *parva*, see Flycatcher, Red-breasted.  
 — *striata*, see Flycatcher, Spotted.
- Neophron percnopterus*, see Vulture, Egyptian.
- Netta rufina*, see Pochard, Red-crested.
- Nicholson, E. M., Telescopes and binoculars: some recent improvements in design and their value for bird-watching, 133-9.  
 —, —, see Boyd, A. W.
- NIGHTINGALE, habitat in Coto Doñana, 8, 10-1; habitat in Camargue, 325, 329, 335, 341, 343, 347; probable occurrence at Fair Isle, 356; numbers ringed 1957, 455.  
 —, THRUSH, at Fair Isle, 198, 356; ringed 1957, 456.
- NIGHTJAR, status in Tiree and Coll, 105, 115; habitat in Camargue, 325, 341; numbers ringed 1957, 454.  
 —, RED-NECKED, habitat in Coto Doñana, 8, 10.
- Nisbet, I. C. T., Photographic studies of some less familiar birds: LXXXIX, Goshawk, 233-7.
- Nucifraga caryocatactes caryocatactes*, see Nutcracker, Thick-billed.  
 — *columbiana*, see Nutcracker, Clark's.
- Numenius arquata*, see Curlew.  
 — *phaeopus*, see Whimbrel.
- NUTCRACKER, CLARK'S, finding buried food, 505.  
 —, THICK-BILLED, concealment and recovery of food, 505-7.
- NUTHATCH, numbers ringed and recovered, 1957, 454; concealment and recovery of food, 500.
- Nyctea scandiaca*, see Owl, Snowy.  
*Nycticorax nycticorax*, see Heron, Night.
- OBITUARIES: John Arthington Walpole-Bond, 1878-1958, 237-9; William Stanley Cowin, 353-4.
- Oceanodroma leucorhoa*, see Petrel, Leach's.
- Oenanthe deserti*, see Wheatear, Desert.  
 — *hispanica*, see Wheatear, Black-eared.  
 — *oenanthe*, see Wheatear.
- ORIOLE, GOLDEN, habitat in Coto Doñana, 10, 21-22, pl. 6; in Coll, 1938, 106; habitat in Camargue, 335, 343, 347.
- Oriolus oriolus*, see Oriole, Golden.
- OSPREY, foreign-ringed recoveries in Britain, 63; migration, 92.
- Otis tetrax*, see Bustard, Little.  
*Otus scops*, see Owl, Scops.
- OUZEL, RING, status in Tiree and Coll, 107, 116; numbers ringed and recovered, 455, 479.
- Owen, D. F., Note on Spotted Crake in Oxfordshire in July, 78.
- OWL, BARN, habitat in Coto Doñana, 9-10, 22; status in Tiree and Coll, 105, 115; habitat in Camargue, 335, 346; numbers ringed and recovered, 1957, 454.  
 —, LITTLE, habitat in Coto Doñana, 9-10, 22; habitat in Camargue, 342, 346; numbers ringed and recovered, 1957, 454.  
 —, LONG-EARED, foreign-ringed recovery in Britain, 69; status in Tiree and Coll, 105, 115; habitat in Camargue, 325, 335, 343, 346; numbers ringed and recovered, 454.  
 —, PYGMY, photographic study, 72-4, pl. 13-16.  
 —, SCOPS, photographic study, 149-52, pl. 25-28; habitat in Camargue, 335, 343.  
 —, SHORT-EARED, status in Tiree and Coll, 105-115; numbers ringed and recovered, 1957, 454.  
 —, SNOWY, status in Tiree and Coll, 105, 115.  
 —, TAWNY, habitat in Camargue, 335, 343; numbers ringed and recovered 1957, 454.
- Oxyura jamaicensis*, see Duck, Ruddy.  
 — *leucocephala*, see Duck, White-headed.
- OYSTERCATCHER, foreign-ringed recoveries in Britain, 63; study of food intake of captive birds, 139-149; status in Tiree and Coll, 52, 113; in N. Atlantic, 152; body-size in relation to migration, 228; habitat in Camargue, 324, 327; numbers ringed and recovered 1957, 453, 467.
- Palmer, Eileen M., Note on nestling Goldfinch's decomposed body rotting feet off rest of brood, 357.
- Pandion haliaëtus*, see Osprey.  
*Panurus biarmicus*, see Tit, Bearded.

REDWING, foreign-ringed recoveries in Britain, 69, 495; status in Tiree and Coll, 107, 116; body-size in relation to migration, 220-1; numbers ringed and recovered 1957, 455, 479; sub-song, 512, pl. 71.

*Regulus ignicapillus*, see Firecrest.

— *regulus*, see Goldcrest.

*Remiz pendulinus*, see Tit, Penduline.

Reports and news, 39-40, 84, 131-2, 164, 203-8, 247-52, 277-84, 314-20, 361-8, 405-8, 432-45, 528-32.

Requests for information: autumn and winter flocks of Coots, 39; status of the rarer Grebes, 39; Treecreepers' roosting sites, 39; birds with deformed bills, 39; albinism and melanism, 39; marked Sand Martins, 39; the 1957 irruptions of tits and other species, 130; interim report, 162; gulls feeding on grain, 130; the place of birds in English folklore, 130; sample census of heronries, 163; roosting-sites, 163; status of the Wryneck, 163; autumn and winter flocks of Coots, 163; survey of Black-headed Gull colonies, 164; status of the Wryneck, 202; survey of Black-headed Gulls, 202; status of the Nightjar, 203; habitats of the Oystercatcher, 203; the winter status of the Eider and the Long-tailed Duck, 447.

#### REVIEWS:—

Bannerman: The birds of the British Isles, Vol. 6, 7, 311-2.

Brown: Summer migrants (film-strip), 431-2.

Brown: British woodland birds (filmstrip), 431-2.

Brown: The Sedge-Warbler (filmstrip), 431-2.

Cadman: Tales of a Wildfowler, 37.

Campbell: The Crested Tit, 314.

Campbell: The Crossbill, 314.

Chislett and Ainsworth: Birds on the Spurn peninsula, Pt. 1, 430-1.

Ennion: Bird study in a garden, 276-7.

Hosking: Birds on the wing (colour slides), 38.

Hosking: Birds and nests (colour slides), 38.

Johnson and Payn: Ornamental waterfowl, 83.

Mountfort: Portrait of a wilderness, 200-2.

Palmer: The Capercailzie, 314.

Pough: Audubon bird guide, 244-6.

Pough: Audubon water bird guide, 244-6.

Pough: Audubon western bird guide, 244-6.

Ronsil: L'art francais dans le livre d'oiseaux, 360.

Snow: A study of Blackbirds, 429-30.

Ticehurst: The Mute Swan in England, 127-8.

Tinbergen: Curious naturalists, 358-60.

Van Someren: A bird watcher in Kenya, 313.

Reynolds, John, Note on Black-winged Pratincole in Somerset, 119.

Richards, T. J., Concealment and recovery of food by birds, with some relevant observations on squirrels, 497-508.

Ring report, 449-96.

*Riparia riparia*, see Martin, Sand.

*Rissa tridactyla*, see Kittiwake.

Roberts, E. L., Note on unusual nest of Song Thrush, 275.

ROBIN, status in Tiree and Coll, 108, 116; autumn migration in Western Approaches, 352; numbers ringed and recovered 1957, 455, 481.

ROLLER, habitat in Camargue, 335, 347.

Rollin, Noble, Late season singing of the Yellowhammer, 290-303.

ROOK, foreign-ringed recovery in Britain, 69; eating sand, 82; status in Tiree and Coll, 106, 116; numbers ringed and recovered 1957, 454, 477; concealment and recovery of food, 501-2, 504.

Rosén, Sigvard, Photograph of Pygmy Owl, pl. 13.

RUFF, status in Tiree and Coll, 55, 114; displaying in wintering area, 81-2; in N. Atlantic, 155; habitat in Camargue, 327, 338; numbers ringed and recovered 1957, 456, 469.

Rutter, G., see Allen, R. 11.

Sage, Bryan L., Note on variant leg and bill colour of the Moorhen, 158.

- Salmon, H. Morrey, Note on Lesser Black-backed and Herring Gulls nesting on a factory roof inland in Glamorgan, 399-401, pl. 68; letter on impressions left by birds striking glass windows, 403-4.
- SANDERLING, status in Tiree and Coll, 55, 114; foreign-ringed recoveries in Britain, 67; in N. Atlantic, 98; numbers ringed and recovered 1957, 456, 469.
- SANDGROUSE, in Tiree and Coll, 105, 115.
- , PIN-TAILED, habitat in Coto Doñana, 17; habitat in Camargue, 342, 347.
- SANDPIPER, BAIRD'S, field-characters, 81.
- , BROAD-BILLED, in Hampshire, 194; correction, 527; in Berkshire, 195.
- , BUFF-BREASTED, in N. Atlantic, 154; in Lanarkshire, 193-4.
- , COMMON, status in Tiree and Coll, 54, 114; numbers ringed and recovered 1957, 453, 468.
- , CURLEW, in Tiree, 1898, 55, 114; numbers ringed 1957, 456.
- , GREEN, numbers ringed and recovered 1957, 456, 468.
- , MARSH, habitat in Camargue, 338.
- , PECTORAL, ringed 1957, 456.
- , PURPLE, status in Tiree and Coll, 54, 114; in N. Atlantic, 154; body-size in relation to migration, 228-9; numbers ringed 1957, 456.
- , SEMI-PALMATED, field-characters, 81.
- , WHITE-RUMPED, in Yorkshire, 80.
- , WOOD, status in Tiree and Coll, 54, 114; habitat in Camargue, 338, 346; numbers ringed 1957, 456.
- Saxicola rubetra*, see Whinchat.
- *torquata*, see Stonechat.
- SCAUP, status in Tiree and Coll, 48, 112; foreign-ringed recoveries in Britain, 60; numbers ringed 1957, 456.
- Schuez, Ernst, Letter on impressions left by birds striking glass windows, 404-5.
- Scolopax rusticola*, see Woodcock.
- SCOTER, COMMON, status in Tiree and Coll, 48, 112; numbers ringed 1957, 456.
- SERIN, habitat in Coto Doñana, 8; at Fair Isle, 199; habitat in Camargue, 346; sub-song of Canary, 513, pl. 71-2.
- Serinus canarius*, see Serin.
- *mozambicus*, see Finch, Green Singing.
- SHAG, status in Tiree and Coll, 46, 112; numbers ringed and recovered 1957, 453, 461.
- Shannon, G. R., Note on Magpie's rapid replacement of dead mate, 401-2.
- SHEARWATER, BALEARIC, off Portland Bill, 27.
- , GREAT, status in Tiree and Coll, 46, 112; in N. Atlantic, 95.
- , LITTLE, in Cheshire, 354; photographic study, 393-7, pl. 64-7.
- , MANX, status in Tiree and Coll, 46, 112; numbers ringed and recovered 1957, 453, 459-60.
- , SOOTY, off Portland Bill, 28; status in Tiree and Coll, 46, 112; in N. Atlantic, 95.
- SHELDUCK, status in Tiree and Coll, 49, 113; foreign-ringed recoveries in Britain, 61, 490; harried by Great Skua, 121; moult migration from Cheshire, 272-4; habitat in Camargue, 327, 330-2; numbers ringed and recovered 1957, 453.
- SHOVELER, status in Tiree and Coll, 47, 112; habitat in Camargue, 327, 341; numbers ringed and recovered 1957, 453, 464; foreign-ringed recoveries in Britain, 490.
- SHRIKE, GREAT GREY, habitat in Coto Doñana, 8, 10, pl. 9; habitat in Camargue, 335, 341, 347.
- , LESSER GREY, habitat in Camargue, 335, 341, 346.
- , RED-BACKED, numbers ringed and recovered 1957, 455.
- , WOODCHAT, at Portland Bill, 29; habitat in Coto Doñana, 8, 10; habitat in Camargue, 335; numbers ringed 1957, 457.
- Silcocks, Trevor, Note on Black Terns feeding on mud-worms, 121.
- Sims, R. W., Note on Killdeer in Cornwall, 398.
- SISKIN, numbers ringed 1957, 455.

- Sitta europaea*, see Nuthatch.
- Sjöberg, Enar, see Ellström, Kurt.
- SKUA, ARCTIC, status in Tiree and Coll, 55, 114; in N. Atlantic, 97; in Western Approaches in spring, 351; numbers ringed and recovered 1957, 454, 469.
- , GREAT, at Portland Bill, 28; status in Tiree and Coll, 55, 114; in N. Atlantic, 97; harrying Shelduck, 121; in spring in Western Approaches, 351; numbers ringed 1957, 454.
- , LONG-TAILED, in N. Atlantic, 97.
- , POMARINE, in Western Approaches in spring, 351.
- SKYLARK, status in Tiree and Coll, 105, 115; nestling fed by Tree Pipit, 310; habitat in Camargue, 326-7, 334, 342, 347; autumn migration in Irish Sea, 353; numbers ringed and recovered 1957, 454.
- SMEW, status in Tiree and Coll, 49, 112; numbers ringed 1957, 456.
- Smith, K. D. and Ash, J. S., Uncommon migrants at Portland Bill during the autumn of 1956, 27-9.
- SNIPE, American race in Lancashire, 35-6; status in Tiree and Coll, 53, 114; foreign-ringed recoveries in Britain, 64, 492; mating display, 79-80; habitat in Camargue, 338; numbers ringed and recovered 1957, 453, 468.
- , JACK, status in Tiree and Coll, 53, 114; habitat in Camargue, 338; numbers ringed and recovered 1957, 453, 468.
- Somateria mollissima*, see Eider.
- SPARROW, HEDGE, see Dunnock.
- , HOUSE, habitat in Coto Doñana, 22; status in Tiree and Coll, 111, 117; habitat in Camargue, 335, 346; numbers ringed and recovered 1957, 455.
- , TREE, status in Tiree and Coll, 11, 117; habitat in Camargue, 335, 346; numbers ringed and recovered 1957, 455.
- , WHITE-THROATED, crossing Atlantic on board ship, 358.
- SPARROWHAWK, foreign-ringed recoveries in Britain, 63; migration in Britain, 86-9; habitat in Camargue, 325, 343; numbers ringed and recovered 1957, 453, 466.
- Spatula clypeata*, see Shoveler.
- Spencer, K. G., Note on Corn Buntings roosting in reeds, 276.
- Spencer, Robert, Report on bird ringing for 1957, 449-96.
- Spinus tristis*, see Goldfinch, American.
- SPOONBILL, habitat in Coto Doñana, 17.
- STARLING, foreign-ringed recoveries in Britain, 71, 496; status in Tiree and Coll, 109, 117; habitat in Camargue, 335, 346; autumn migration in Western Approaches, 352; numbers ringed and recovered 1957, 455, 484.
- , SPOTLESS, habitat in Coto Doñana, 22.
- Stercorarius longicaudus*, see Skua, Long-tailed.
- , *parasiticus*, see Skua, Arctic.
- , *pomarinus*, see Skua, Pomarine.
- , *skua*, see Skua, Great.
- Sterna albifrons*, see Tern, Little.
- , *anaethetus*, see Tern, Bridled.
- , *dougallii*, see Tern, Roseate.
- , *hirundo*, see Tern, Common.
- , *macrura*, see Tern, Arctic.
- , *sandvicensis*, see Tern, Sandwich.
- STILT, BLACK-WINGED, habitat in Coto Doñana, 17-18, pl. 1; habitat in Camargue, 327, 337, 345-6, pl. 57.
- STINT, LITTLE, status in Tiree and Coll, 54, 114; numbers ringed 1957, 456.
- Stokoe, Ralph, The spring plumage of the Cormorant, 165-79, pl. 34-5; note on the leg colour of the Kittiwake, 398-9.
- STONECHAT, habitat in Coto Doñana, 10-11; status in Tiree and Coll, 107, 116; decrease in Camargue, 347; numbers ringed and recovered 1957, 455, 481.
- STORK, WHITE, habitat in Coto Doñana, 10, 19, pl. 6.
- Streptopelia turtur*, see Dove, Turtle.
- Strix aluco*, see Owl, Tawny.
- Sturnus unicolor*, see Starling, Spotless.
- , *vulgaris*, see Starling.
- Sula bassana*, see Gannet.
- Sutton, Gerald A., Note on White-winged Black Tern in Sussex, 160.
- Svensk, Jonas, see Ellström, Kurt.



- Swaine, Christopher M., Note on cock Blackbird feeding juvenile Song Thrush, 309.
- SWALLOW, habitat in Coto Doñana, 22; status in Tiree and Coll, 105, 115; habitat in Camargue, 342, 346; spring migration in Western Approaches, 351; numbers ringed and recovered 1957, 454, 476; foreign-ringed recovery in Britain, 494.
- SWAN, BEWICK'S, status in Tiree and Coll, 50, 113; foreign-ringed recovery in Britain, 62.
- , MUTE, status in Tiree and Coll, 50, 113; numbers ringed and recovered 1957, 453, 466.
- , WHOOPER, status in Tiree and Coll, 50, 113.
- SWIFT, status in Tiree and Coll, 105, 115; habitat in Camargue, 346; numbers ringed and recovered 1957, 454, 476.
- , ALPINE, in Norfolk, 36-7.
- Sylvia atricapilla*, see Blackcap.
- *borin*, see Warbler, Garden.
- *cantillans*, see Warbler, Sub-alpine.
- *communis*, see Whitethroat.
- *conspicillata*, see Warbler, Spectacled.
- *curruca*, see Whitethroat, Lesser.
- *hortensis*, see Warbler, Orphean.
- *melanocephala*, see Warbler, Sardinian.
- *nisoria*, see Warbler, Barred.
- *undata*, see Warbler, Dartford.
- Syrrhaptes paradoxus*, see Sandgrouse, Pallas's
- Tadorna tadorna*, see Shelduck.
- TANAGER, SUMMER, ringed 1957, 457.
- Tarsiger cyanurus*, see Bluetail, Red-flanked.
- Taverner, J. H., Note on a Corn Bunting roost in reeds, 126.
- TEAL, habitat in Coto Doñana, 17; status in Tiree and Coll, 47, 112; foreign-ringed recoveries in Britain, 59, 489; habitat in Camargue, 327, 341, 346; numbers ringed and recovered 1957, 453, 462.
- TERN, ARCTIC, foreign-ringed recoveries in Britain, 69; status in Tiree and Coll, 104, 115; numbers ringed and recovered 1957, 454, 473.
- TERN, BLACK, habitat in Coto Doñana, 17; food, 121; large passage in Somerset, September, 1957, 242-3; habitat in Camargue, 347.
- , BRIDLED, photographic study, 303-8, pl. 45-48.
- , CASPIAN, habitat in Coto Doñana, 3.
- , COMMON, foreign-ringed recoveries in Britain, 68, 494; status in Tiree and Coll, 103, 115; habitat in Camargue, 324, 327, 330-2; numbers ringed and recovered 1957, 454, 473.
- , GULL-BILLED, habitat in Coto Doñana, 17-18; habitat in Camargue, 324, 327, 330-2, 347, pl. 50.
- , LITTLE, habitat in Coto Doñana, 17-18; status in Tiree and Coll, 104, 115; habitat in Camargue, 324, 327, 330-2; numbers ringed and recovered 1957, 454, 474.
- , ROSEATE, status in Tiree and Coll, 104, 115; habitat in Camargue, 327; numbers ringed and recovered 1957, 454, 474.
- , SANDWICH, foreign-ringed recoveries in Britain, 69, 494; status in Tiree and Coll, 104, 115; habitat in Camargue, 327, 330-2; numbers ringed and recovered 1957, 454, 474.
- , WHISKERED, habitat in Coto Doñana, 17; habitat in Camargue, 337, 347, pl. 58.
- , WHITE-WINGED BLACK, in Lincolnshire, 159; in Kent, 160; in Sussex, 160.
- TERNS, in N. Atlantic, 98.
- Tetrao urogallus*, see Capercaillie.
- Thomson, A. Landsborough, The migrations of British hawks (Accipitridae) as shown by ringing results, 85-93; the migrations of British falcons (Falconidae), as shown by ringing results, 179-188; letter on social flying of Ravens, 246-7.
- Thorpe, W. H. and Pilcher, P. M., The nature and characteristics of sub-song, 509-14, pl. 69-74.
- THRUSH, BLACK-THROATED, at Fair Isle, 195, pl. 33; ringed 1957, 456.
- , MISTLE, status in Tiree and Coll, 107, 116; habitat in Camargue, 335; numbers ringed

- and recovered 1957, 455, 479; sub-song, 512, pl. 70.
- THRUSH, SONG, foreign-ringed recovery in Britain, 69; status in Tiree and Coll, 107, 116; unusual nest, 275; juvenile fed by Blackbird, 309; numbers ringed and recovered 1957, 455, 479; sub-song, 512, pl. 69-70.
- THRUSHES, see also Blackbird, Fieldfare, Ouzel, Redwing.
- TIT, BEARDED, habitat in Camargue, 339; numbers ringed 1957, 456.
- , BLUE, habitat in Camargue, 335, 343; behaviour towards other birds at nest, 427; numbers ringed and recovered 1957-58, 454, 477; concealment of food, 499; intelligence tests, 515-24, pl. 75.
- , COAL, at Portland Bill, 28; concealment of food, 122, 497-9, 527; behaviour towards other birds at nest, 427; numbers ringed and recovered 1957, 454, 478; intelligence tests, 515-24, pl. 76.
- , CRESTED, concealment of food, 499.
- , GREAT, at Portland Bill, 28; status in Tiree and Coll, 106, 116; habitat in Camargue, 335, 343, 347; killing and carrying Goldcrest, 355; behaviour towards other birds and mammals at nest, 427-8; numbers ringed and recovered 1957-58, 454, 477; intelligence tests, 515-24.
- , LONG-TAILED, habitat in Camargue, 343; numbers ringed and recovered 1957, 454.
- , MARSH, numbers ringed and recovered 1957, 454; concealment of food, 498-9; intelligence tests, 515-24.
- , PENDULINE, habitat in Camargue, 335, pl. 54.
- , SIBERIAN, concealment of food, 499.
- , WILLOW, concealment of food, 122, 499, 527; numbers ringed 1957, 454.
- Townsend, A. D., Note on abnormal growths on the legs and feet of Chaffinch and Blackbird, 310.
- TREECREEPER, numbers ringed and recovered 1957, 455.
- , SHORT-TOED, habitat in Camargue, 343.
- Tringa erythropus*, see Redshank, Spotted.
- *glareola*, see Sandpiper, Wood.
- *hypoleucos*, see Sandpiper, Common.
- *nebularia*, see Greenshank.
- *ochropus*, see Sandpiper, Green.
- *stagnatilis*, see Sandpiper, Marsh.
- *totanus*, see Redshank.
- Troglodytes troglodytes*, see Wren.
- — *fridariensis*, see Wren, Fair Isle.
- — *hirtensis*, see Wren, St. Kilda.
- Tryngites subruficollis*, see Sandpiper, Buff-breasted.
- Turdus merula*, see Blackbird.
- *musicus*, see Redwing.
- *philomelos*, see Thrush, Song.
- *pilaris*, see Fieldfare.
- *ruficollis atrogularis*, see Thrush, Black-throated.
- *torquatus*, see Ouzel, Ring.
- *viscivorus*, see Thrush, Mistle.
- TURNSTONE, status in Tiree and Coll, 52, 114; foreign-ringed recoveries in Britain, 64, 492; in N. Atlantic, 153; numbers ringed and recovered 1957, 453.
- TWITE, status in Tiree and Coll, 110, 117; numbers ringed 1957, 455.
- Tyto alba*, see Owl, Barn.
- Upupa epops*, see Hoopoe.
- Uria aalge*, see Guillemot.
- *grylle*, see Guillemot, Black.
- *lomvia*, see Guillemot, Brünich's.
- Urquhart, L. A., Note on Buff-breasted Sandpiper in Lanarkshire, 193-4.
- Valverde, J. A., An ecological sketch of the Coto Doñana, 1-23, pl. 1-12.
- Vanellus vanellus*, see Lapwing.
- Vaughan, Richard, Photographs of Alpine Chough, pl. 21-22, 24.
- Venables, L. S. V. and Venables, U. M., Notes on abnormal Dipper breeding in N. Wales, 124; on Reed Warbler in Co. Down, 124; on the song-period of the Woodpigeon in Flintshire, 160-1.
- Venables, L. S. V., see Mulligan, W.
- Vermivora peregrina*, see Warbler, Tennessee.
- VOICE: sub-song, 509-14, pl. 69-74; Woodpigeon, 160-1; Willow Warbler, 83; Yellowhammer, 290-303.

- BUNTING, RUSTIC, at Fair Isle, 199; ringed 1957, 457.  
 —, SNOW, in N. Atlantic, 99; status in Tiree and Coll, 111, 117; body-size in relation to migration, 223-4; numbers ringed 1957, 445.  
 —, YELLOW, see Yellowhammer.  
*Burhinus oedicephalus*, see Curlew, Stone.  
 BUSTARD, LITTLE, habitat in Camargue, 342.  
*Buteo buteo*, see Buzzard.  
 — *lagopus*, see Buzzard, Rough-legged.  
 BUZZARD, habitat in Coto Doñana, 8, 10-11; status in Tiree and Coll, 50, 113; migration in Britain, 86; numbers ringed and recovered 1957, 453.  
 —, HONEY, in Lancashire, 78.  
 —, ROUGH-LEGGED, foreign-ringed recovery in Britain, 86.  
*Calandrella cinerea*, see Lark, Short-toed.  
 — *rufescens*, see Lark, Lesser Short-toed.  
*Calcarius lapponicus*, see Bunting, Lapland.  
*Calidris alpina*, see Dunlin.  
 — *bairdii*, see Sandpiper, Baird's.  
 — *canutus*, see Knot.  
 — *fuscicollis*, see Sandpiper, White-rumped.  
 — *maritima*, see Sandpiper, Purple.  
 — *melanotos*, see Sandpiper, Pectoral.  
 — *minilla*, see Stint, Little.  
 — *pusilla*, see Sandpiper, Semipalmated.  
 — *testacea*, see Sandpiper, Curlew.  
 Cambridge Bird Club, Note on Pallas's Warbler in Norfolk, 197.  
 CANARY, see Serin.  
*Capella gallinago*, see Snipe.  
 CAPERCAILLIE, photographic study, 189-92, pl. 29-32.  
*Caprimulgus europaeus*, see Nightjar.  
 — *ruficollis*, see Nightjar, Red-necked.  
*Carduelis cannabina*, see Linnet.  
 — *carduelis*, see Goldfinch.  
 — *flammea*, see Redpoll.  
 — *flavivestris*, see Twite.  
 — *spinus*, see Siskin.  
 Caris, J. L., Note on Great Tit killing and carrying Goldcrest, 355.  
*Carpodacus erythrinus*, see Grosbeak, Scarlet.  
 Carr, Douglas and Veysey, C. M., Note on Broad-billed Sandpiper in Berkshire, 195.  
 Cawston, A. C., Note on White-winged Black Tern in Kent, 160.  
*Certhia brachydactyla*, see Treecreeper, Short-toed.  
 — *familiaris*, see Treecreeper.  
*Cettia cetti*, see Warbler, Cetti's.  
 CHAFFINCH, foreign-ringed recoveries in Britain, 71, 496; status in Tiree and Coll, 110, 117; abnormal growth on foot, 310; habitat in Camargue, 335, 343; numbers ringed and recovered 1957, 455, 486; sub-song, 510-2.  
*Charadrius alexandrinus*, see Plover, Kentish.  
 — *apricarius*, see Plover, Golden.  
 — *dubius*, see Plover, Little Ringed.  
 — *hiaticula*, see Plover, Ringed.  
 — *morinellus*, see Dotterel.  
 — *squatarola*, see Plover, Grey.  
 — *vociferus*, see Killdeer.  
 CHIFFCHAFF, at Portland Bill, 28; status in Tiree and Coll, 108, 116; taking insects from water, 309; numbers ringed and recovered 1957, 455, 483.  
*Chlidonias hybrida*, see Tern, Whiskered.  
 — *leucopterus*, see Tern, White-winged Black.  
 — *niger*, see Tern, Black.  
*Chloris chloris*, see Greenfinch.  
 CHOUGH, photographic study, 99-103, pl. 23; status in Tiree and Coll, 106, 116; numbers ringed and recovered 1957, 454, 477.  
 —, ALPINE, photographic study, 99-103, pl. 21-22, 24.  
*Ciconia ciconia*, see Stork, White.  
*Cinclus cinclus*, see Dipper.  
*Circæetus gallicus*, see Eagle, Short-toed.  
*Circus aeruginosus*, see Harrier, Marsh.  
 — *cyaneus*, see Harrier, Hen.  
 — *pygargus*, see Harrier, Montagu's.  
*Cisticola juncidis*, see Warbler, Fan-tailed.  
 Clifton, F. R., Note on Green Singing Finch living "wild" in Hampshire, 311.  
*Clamator glandarius*, see Cuckoo, Great Spotted.  
*Clangula hyemalis*, see Duck, Long-tailed.  
*Coccothraustes coccothraustes*, see Hawfinch.

- Cockbain, R. P., Note on Tree Pipits feeding nestling Skylarks and removing faecal sacs, 310.
- Columba livia*, see Dove, Rock.
- *oenas*, see Dove, Stock.
- *palumbus*, see Woodpigeon.
- Cooper, P. E. D., Note on attempted coition between House Martin and Sand Martin, 308-9.
- COOT, habitat in Coto Doñana, 17, 20; status in Tiree and Coll, 51, 113; foreign-ringed recovery in Britain, 63; habitat in Camargue, 337-9; numbers ringed and recovered 1957, 453, 467; foreign-ringed recovery in Britain, 491.
- , CRESTED, habitat in Coto Doñana, 17, 20.
- Coracias garrulus*, see Roller.
- CORMORANT, status in Tiree and Coll, 46, 112; spring plumage, 165-176, pl. 34-35; validity of races *carbo* and *sinensis*, 165-179; migration, 176; habitat in Camargue, 327, 338; numbers ringed and recovered 1957, 453, 461.
- CORNCRAKE, status in Tiree and Coll, 51, 113; numbers ringed 1957, 453.
- Corvus corax*, see Raven.
- *corone*, see Crow, Carrion.
- — *cornix*, see Crow, Hooded.
- *frugilegus*, see Rook.
- *monedula*, see Jackdaw.
- Coturnix coturnix*, see Quail.
- Cowdy, Susan, Note on Rooks eating sand, 82.
- Cox, R. A. F., Note on Alpine Swift in Norfolk, 36-7.
- CRAKE, BAILLON'S, habitat in Coto Doñana, 17; habitat in Camargue, 339.
- , LITTLE, habitat in Camargue, 339.
- , SPOTTED, in Cheshire in July, 78; in Oxfordshire in July, 78; habitat in Camargue, 339; ringed 1957, 456.
- CRAKES, see also Cornerake.
- Crex crex*, see Cornerake.
- Crocethia alba*, see Sanderling.
- CROSSBILL, numbers ringed 1957, 455; song, 513, pl. 73.
- , SCOTTISH, sub-song, 513, pl. 74.
- CROW, CARRION, status in Tiree and Coll, 106, 116; habitat in Camargue, 325, 335, 343, 346; numbers ringed and recovered 1957, 454.
- CROW, HOODED, status in Tiree and Coll, 106, 116; numbers ringed and recovered 1957, 454.
- CROWS, see also Chough, Jackdaw, Jay, Magpie, Nutcracker, Raven, Rook.
- CUCKOO, status in Tiree and Coll, 105, 115; habitat in Camargue, 335, 343; numbers ringed and recovered 1957, 454, 476.
- , GREAT SPOTTED, habitat in Coto Doñana, 8, 10; habitat in Camargue, 341, 346.
- Cuculus canorus*, see Cuckoo.
- CURLEW, status in Tiree and Coll, 53, 114; foreign-ringed recoveries in Britain, 65, 492; in N. Atlantic, 153; numbers ringed and recovered 1957, 453.
- , STONE, habitat in Coto Doñana, 3, 8, 10, 17, 21; habitat in Camargue, 334, 341-2, 347; numbers ringed and recovered 1957, 454, 469.
- Curry-Lindahl, Kai, Photographic studies of some species rarely photographed: LXXXV, Pygmy Owl, 72-4.
- Cusa, N. W., see Bennett, C. G.
- Cyanopica cyanus*, see Magpie, Azure winged.
- Cyanosylvia svecica*, see Bluethroat.
- Cygnus columbianus bewickii*, see Swan, Bewick's.
- *cygnus*, see Swan, Whooper.
- *olor*, see Swan, Mute.
- Davis, Peter, Notes on Black-throated Thrush at Fair Isle, 195-7; on Thrush Nightingale at Fair Isle, 198; on Serin at Fair Isle, 199; on Rustie Bunting at Fair Isle, 199; on Lanceolated Warbler at Fair Isle, 243-4.
- , —, and Jones, Peter Hope, Note on Thrush Nightingale and probable Nightingale at Fair Isle, and the problem of identification, 356-7.
- Davis, T. A. W., see Barrett, John H.
- Delichon urbica*, see Martin, House.
- Dendroica pinus*, see Warbler, Pine.
- *virens*, see Warbler, Black-throated Green.
- Dendrocopus major*, see Woodpecker, Great Spotted.
- *minor*, see Woodpecker, Lesser Spotted.
- Dickens, R. F. see Mather, J. R.

- DIPPER, abnormal male breeding in N. Wales, 124; numbers ringed and recovered 1957, 455, 479.
- DISPLAY: Snipe, 79; Ruff, 81-2; Willow Warbler, 83.
- DIVER, BLACK-THROATED, status in Tiree and Coll, 45, 112; ringed 1957, 456.
- , GREAT NORTHERN, status in Tiree and Coll, 45, 112.
- , RED-THROATED, status in Tiree and Coll, 45, 112.
- Donovan, J. W., Note on Pratincole or Black-winged Pratincole in Sussex, 120.
- DOTTEREL, at Portland Bill, 28; numbers ringed 1957, 456.
- DOVE, ROCK, status in Tiree and Coll, 105, 115; numbers ringed and recovered 1957, 454.
- , STOCK, foreign-ringed recovery in Britain, 69; numbers ringed and recovered 1957, 454.
- , TURTLE, habitat in Coto Doñana, 8; in N. Atlantic, 98; status in Tiree and Coll, 105, 115; habitat in Camargue, 335, 341-3; numbers ringed and recovered 1957, 454, 475.
- DOVES, see also Woodpigeon.
- Drinnan, R. E., Observations on the feeding of the Oystercatcher in captivity, 139-49.
- DUCK, FERRUGINOUS, habitat in Coto Doñana, 17, 20.
- , LONG-TAILED, status in Tiree and Coll, 48, 112.
- , MARBLED, habitat in Coto Doñana, 17, 20.
- , RUDDY, field-characters, 239-41.
- , SHELD, see Shelduck.
- , TUFTED, status in Tiree and Coll, 48, 112; foreign-ringed recoveries in Britain, 61; habitat in Camargue, 340; breeding biology in St. James's Park, London, 413-26; numbers ringed and recovered 1957, 453, 465.
- , WHITE-HEADED, breeding in Coto Doñana, 17, 20; field-characters, 239-41.
- DUCKS, see also Eider, Gadwall, Garganey, Goldeneye, Goosander, Mallard, Merganser, Pintail, Pochard, Scaup, Scoter, Shelduck, Shoveler, Smew, Teal, Wigeon.
- DUNLIN, status in Tiree and Coll, 55, 114; foreign-ringed recoveries in Britain, 66, 493; in N. Atlantic, 98; habitat in Camargue, 327; spring migration in Western Approaches, 351; numbers ringed and recovered 1957, 454, 469.
- DUNNOCK, sub-song, 513, pl. 74.
- EAGLE, BONELLI'S, habitat in Camargue, 335.
- , BOOTED, habitat in Coto Doñana, 8, 10, 11, 14.
- , GOLDEN, recovery of ringed, 86; numbers ringed and recovered 1957, 456, 466.
- , IMPERIAL, habitat in Coto Doñana, 4, 8, 10, 11, pl. 7.
- , SHORT-TOED, habitat in Coto Doñana, 4, 8, 12, pl. 3; habitat in Camargue, 335.
- EDITORIAL: The London Natural History Society's centenary, 409-12.
- EGRET, CATTLE, habitat in Coto Doñana, 10, 19; habitat in Camargue, 344.
- , LITTLE, habitat in Coto Doñana, 10, 19, pl. 6; habitat in Camargue, 325, 328, 338, 343-6, pl. 53.
- Egretta garzetta*, see Egret, Little.
- EIDER, status in Tiree and Coll, 48, 113; method of eating crabs, 308; habitat in Camargue, 324; numbers ringed and recovered 1957, 453.
- Ellström, Kurt and Sjöberg, Enar, Photographs of Pygmy Owl, pl. 14-16.
- , —, —, and Svensk, Jonas, Photographs of Capercaillie, pl. 29-32.
- , —, and Svensk, Jonas, Photographs of Goshawk, pl. 37-40.
- Emberiza bruniceps*, see Bunting, Red-headed.
- *calandra*, see Bunting, Corn.
- *cirlus*, see Bunting, Cirl.
- *citrinella*, see Yellowhammer.
- *hortulana*, see Bunting, Ortolan.
- *pusilla*, see Bunting, Little.
- *rustica*, see Bunting, Rustic.
- *schoeniclus*, see Bunting, Reed.
- Erithacus rubecula*, see Robin.
- Falco columbarius*, see Merlin.
- *naumanni*, see Kestrel, Lesser.
- *peregrinus*, see Peregrine.

- Falco rusticolus candicans*, see Falcon, Greenland.  
 ——— *islandus*, see Falcon, Iceland Gyr.  
 ——— *subbuteo*, see Hobby.  
 ——— *tinnunculus*, see Kestrel.  
 FALCON, GREENLAND, in Tiree and Coll, 1901, 51, 113.  
 ———, ICELAND GYR, breeding biology, 285-90.  
 ———, PEREGRINE, see Peregrine.  
 FALCONS, see also Hobby, Kestrel, Merlin.  
 Ferguson-Lees, I. J., Photographic studies of some less familiar birds: LXXXVI, Chough and Alpine Chough, 99-103, pl. 21-4; LXXXVII, Scops Owl, 149-52, pl. 25-28; note on the identification of White-headed and Ruddy Ducks, 239-41.  
 ———, ———, Recent reports and news, see Reports and news.  
 FIELD-CHARACTERS: Cormorant, 165-75; Ruddy Duck, 239-41; White-headed Duck, 239-41; Baird's Sandpiper, 81; Semipalmated Sandpiper, 81; Kittiwake, 398-9; Thrush Nightingale, 356-7; Nightingale, 356-7.  
 FIELDFARE, foreign-ringed recoveries in Britain, 69, 495; status in Tiree and Coll, 106, 116; numbers ringed 1957, 455.  
 FINCH, GREEN SINGING, living "wild" in Hampshire, 311.  
 FINCHES, see also Bullfinch, Chaffinch, Goldfinch, Greenfinch, Hawfinch.  
 FIRECREST, at Portland Bill, 28; numbers ringed 1957, 456.  
 FLAMINGO, habitat in Camargue, 328-32, pl. 51.  
 Flower, W. U., Note on Goldcrest caught on hooks of burdock, 276.  
 FLYCATCHER, COLLARED, on Bardsey, 36.  
 ———, PIED, status in Tiree and Coll, 109, 117; numbers ringed and recovered 1957, 455.  
 ———, RED-BREADED, at Portland Bill, 28; numbers ringed 1957, 456.  
 ———, SPOTTED, status in Tiree and Coll, 109, 116; habitat in Camargue, 335, 343; numbers ringed and recovered 1957, 455, 483.  
 FOOD: Black Tern, 121.  
*Fraterecula arctica*, see Puffin.  
*Fregata magnificens*, see Frigate-bird, Magnificent.  
 FRIGATE-BIRD, MAGNIFICENT, in Tiree, 1953, 46, 112.  
*Fringilla coelebs*, see Chaffinch.  
 ——— *montifringilla*, see Brambling.  
 Fry, C. H., Note on Red Grouse swimming, 241.  
*Fulica atra*, see Coot.  
 ——— *cristata*, see Coot, Crested.  
 FULMAR, status in Tiree and Coll, 46, 112; in N. Atlantic, 95; numbers ringed and recovered 1957, 453, 460.  
*Fulmarus glacialis*, see Fulmar.  
 GADWALL, habitat in Coto Doñana, 17; status in Tiree and Coll, 47, 112; foreign-ringed recoveries in Britain, 60, 489; habitat in Camargue, 327, 330-2, 337, 341; numbers ringed and recovered 1957, 453, 463.  
*Galerida cristata*, see Lark, Crested.  
 ——— *theklae*, see Lark, Thekla.  
*Gallinula chloropus*, see Moorhen.  
 GALLINULE, PURPLE, habitat in Coto Doñana, 17.  
 GANNET, status in Tiree and Coll, 46, 112; in N. Atlantic, 96-7; numbers ringed and recovered 1957, 453, 460.  
 GARGANEY, foreign-ringed recoveries in Britain, 59; habitat in Coto Doñana, 17; habitat in Camargue, 337, 340, 346; numbers ringed and recovered 1957, 456, 463.  
*Garrulus glandarius*, see Jay.  
*Gavia arctica*, see Diver, Black-throated.  
 ——— *immer*, see Diver, Great Northern.  
 ——— *stellata*, see Diver, Red-throated.  
*Gelochelidon nilotica*, see Tern, Gull-billed.  
 Gillham, E. H., Further notes on the Tufted Duck in St. James's Park, London, 413-26.  
*Glareola nordmanni*, see Pratincole, Black-winged.  
 ——— *pratinnicola*, see Pratincole.  
*Glaucidium passerinum*, see Owl, Pygmy.  
 GODWIT, BAR-TAILED, status in Tiree and Coll, 54, 114; foreign-ringed recoveries in Britain, 65, 492; numbers ringed 1957, 456.

- GODWIT, BLACK-TAILED**, status in Tiree and Coll, 54, 114; body-size in relation to migration, 229; habitat in Camargue, 327, 338, 346; breeding in Britain, 524-5.
- GOLDCREST**, status in Tiree and Coll, 108, 116; caught on burdock, 276; killed by Great Tit, 355; numbers ringed 1957, 455.
- GOLDENEYE**, status in Tiree and Coll, 48, 112; foreign-ringed recovery in Britain, 490.
- GOLDFINCH**, habitat in Coto Doñana, 8, 21; habitat in Camargue, 325, 335, 346; nestling's decomposed body rotting feet off rest of brood, 357; numbers ringed and recovered 1957, 455, 486.
- , **AMERICAN**, sub-song, 513, pl. 72.
- GOOSANDER**, status in Tiree and Coll, 49, 113; foreign-ringed recovery in Britain, 61; numbers ringed 1957, 456.
- GOOSE, BARNACLE**, status in Tiree and Coll, 49, 113; foreign-ringed recoveries in Britain, 62.
- , **BRENT**, status in Tiree and Coll, 49, 113; foreign-ringed recoveries in Britain, 62.
- , **CANADA**, in Tiree, 50, 113; numbers ringed and recovered 1957, 453, 465.
- , **GREY LAG**, status in Tiree and Coll, 49, 113; numbers ringed and recovered 1957, 453.
- , **PINK-FOOTED**, foreign-ringed recoveries in Britain, 61; numbers ringed and recovered 1957, 453, 465.
- , **RED-BREASTED**, in Sussex, 192.
- , **WHITE-FRONTED**, status in Tiree and Coll, 49, 113; foreign-ringed recoveries in Britain, 61; body-size in relation to migration, 229-30; numbers ringed and recovered 1957, 453, 465.
- GOSHAWK**, photographic study, 233, pl. 37-40.
- GREBE, BLACK-NECKED**, habitat in Coto Doñana, 17, 20; nesting in the Oberlausitz, pl. 17.
- , **GREAT CRESTED**, habitat in Coto Doñana, 17, 20; status in Tiree and Coll, 45, 112; habitat in Camargue, 337-9; numbers ringed 1957, 456.
- GREBE, LITTLE**, habitat in Coto Doñana, 17, 20; status in Tiree and Coll, 46, 112; habitat in Camargue, 337-9; numbers ringed and recovered, 1957, 453.
- , **RED-NECKED**, status in Tiree and Coll, 45, 112.
- , **SLAVONIAN**, status in Tiree and Coll, 46, 112.
- GREENFINCH**, status in Tiree and Coll, 110, 117; habitat in Camargue, 335, 346; numbers ringed and recovered 1957, 455, 486.
- GREENSHANK**, status in Tiree and Coll, 54, 114; numbers ringed and recovered 1957, 456, 468, winter status in W. Wales, 525-7.
- GROSBEAK, SCARLET**, numbers ringed 1957, 457.
- GROUSE, BLACK**, numbers ringed 1957, 456.
- , **RED**, status in Tiree and Coll, 51, 113; swimming, 241; numbers ringed and recovered 1957, 453.
- GUILLEMOT**, status in Tiree and Coll, 104, 115; numbers ringed and recovered 1957, 454, 475.
- , **BLACK**, status in Tiree and Coll, 104, 115; numbers ringed and recovered 1957, 454, 475.
- , **BRUNNICH'S**, in N. Atlantic, 98.
- GULL, BLACK-HEADED**, status in Tiree and Coll, 56, 115; foreign-ringed recoveries in Britain, 68; nesting in the Oberlausitz, pl. 17; recoveries in Britain of birds ringed in E. Germany, 74-7; habitat in Camargue, 325, 327, 330-2, 338, 347; numbers ringed and recovered 1957, 454, 471.
- , **COMMON**, status in Tiree and Coll, 56, 114; foreign-ringed recoveries in Britain, 68; numbers ringed and recovered 1957, 454, 470.
- , **GLAUCOUS**, status in Tiree and Coll, 56, 115.
- , **GREAT BLACK-BACKED**, status in Tiree and Coll, 55; foreign-ringed recoveries in Britain, 67, 114, 493; in N. Atlantic, 97; numbers ringed and recovered 1957, 454, 469.
- , **HERRING**, status in Tiree and Coll, 56, 114; foreign-ringed recoveries in Britain, 68, 494; in N. Atlantic, 97; habitat in

- Camargue, 324, 327, 330-2, 338, 346; nesting inland on roof, 399-401, pl. 68; numbers ringed and recovered 1957, 454, 470.
- GULL, ICELAND, status in Tiree and Coll, 56, 115; foreign-ringed recovery in Britain, 68.
- , LESSER BLACK-BACKED, status in Tiree and Coll, 55, 114; foreign-ringed recoveries in Britain, 67, 493; in N. Atlantic, 97; nesting inland on roofs, 399-401; numbers ringed and recovered 1957, 454, 470.
- , LITTLE, off Portland Bill, 28; status in Tiree and Coll, 56, 115.
- , SABINE'S, status in Tiree and Coll, 56, 115.
- , SLENDER-BILLED, habitat in Coto Doñana, 17; habitat in Camargue, 327.
- GULLS, see also Kittiwake.
- Gyps fulvus*, see Vulture, Griffon.
- GYRFALCON, see Falcon, Gyr.
- Haematopus ostralegus*, see Oystercatcher.
- Hall, G. Harper, Letter on eggs disappearing from Peregrine eyries, 402-3.
- Harle, Dennis F., Note on Red-flanked Bluetail in Kent, 37.
- HARRIER, HEN, status in Tiree and Coll, 50, 113; migration, 89-91; numbers ringed and recovered 1957, 453.
- , MARSH, habitat in Coto Doñana, 17; migration, 89; habitat in Camargue, 339; numbers ringed and recovered 1957, 456, 466.
- , MONTAGU'S, migration, 91-2; habitat in Camargue, 339; numbers ringed 1957, 453.
- Harrison, Jeffery G., Note on Cliffchaff and Whitethroat taking insects from water, 309.
- Hart, David, Notes on hoarding of food by Willow Tit, 122; on hoarding of food by Coal Tit, 122; on hoarding of food by Willow and Coal Tits, 527.
- HAWFINCH, in Tiree and Coll, 1904, 109; numbers ringed 1957, 455.
- Hayman, R. W., Note on Magpie burying and recovering food, 275.
- Haywood, P. B., see West, D. G. H.
- Hazelwood, Alfred, Note on American Snipe in Lancashire, 35-6.
- Henty, C. J., see Billett, D. F.
- HERON, habitat in Coto Doñana, 10, 19; status in Tiree and Coll, 47, 112; foreign-ringed recoveries in Britain 58, 488; fish-hook in pellet, 156; habitat in Camargue, 328, 338; numbers ringed and recovered 1957, 453, 461.
- , NIGHT, habitat in Coto Doñana, 10, 17, 19, pl. 6; habitat in Camargue, 325, 343-6.
- , PURPLE, habitat in Coto Doñana, 17, 20, 21; habitat in Camargue, 328, 338-9, 343-6, pl. 59.
- , SQUACCO, habitat in Coto Doñana, 19; habitat in Camargue, 325, 343-4, 346.
- Hieraëtus fasciatus*, see Eagle, Bonelli's.
- *pennatus*, see Eagle, Booted.
- Hill, D. S., Flatflies wanted (letter), 161.
- Himantopus himantopus*, see Stilt, Black-winged.
- Hippolais icterina*, see Warbler, Icterine.
- *pallida*, see Warbler, Olivaceous.
- *polyglotta*, see Warbler, Melodious.
- Hirundo rustica*, see Swallow.
- HOBBY, habitat in Coto Doñana, 8; migration, 179-80; habitat in Camargue, 325, 343; numbers ringed 1957, 456.
- Hoffmann, L., An ecological sketch of the Camargue, 321-350, pl. 49-60.
- HOOPOE, habitat in Coto Doñana, 22; habitat in Camargue, 335, 342; ringed 1957, 456.
- Hosking, Eric, Note on fish-hook in Heron's pellet, 156.
- Hydrobates pelagicus*, see Petrel, Storm.
- Hydroprogne caspia*, see Tern, Caspian.
- IBIS, GLOSSY, in Tiree and Coll, 1901, 47, 112; in Dorset, 118.
- Ixobrychus minutus*, see Bittern, Little.
- JACKDAW, habitat in Coto Doñana, 9-10, 22; status in Tiree and Coll, 106, 116; habitat in Camargue, 335, 343, 346; numbers ringed and recovered 1957, 454, 477; foreign-ringed recovery in Britain, 495.



- JAY, habitat in Camargue, 343; concealment and recovery of food, 500-1, 504-5, 507.
- Jolly, G. F., see Wayre, Philip.
- Jones, E. L., see Bowers, J. K.
- Jones, Peter Hope, see Davis, Peter.
- Jynx torquilla*, see Wryneck.
- KESTREL, habitat in Coto Doñana, 8, 10, 12, 21-2; status in Tiree and Coll, 51, 113; migration, 183-8; habitat in Camargue, 325, 329, 335, 342; numbers ringed and recovered 1957, 453, 466.
- , LESSER, habitat in Camargue, 342, 346.
- KILLDEER, in Cornwall, 398.
- King, Bernard, Notes on Willow Warbler's unusual song and display-flight, 83; on apparent coition between House Martin and Sand Martin, 121.
- KINGFISHER, status in Tiree and Coll, 105, 115; habitat in Camargue, 335; numbers ringed and recovered 1957, 454.
- KITE, habitat in Coto Doñana, 8, 10-11.
- , BLACK, habitat in Coto Doñana, 8, 10, 11, 14-15, 22, pl. 7; habitat in Camargue, 325, 335, 338, 343.
- KITTIWAKE, status in Tiree and Coll, 56; in N. Atlantic, 97; wreck in Britain, 1957, 253-66; heavy mortality in breeding season, 267-8; in spring in Western Approaches, 351; leg colour, 398; numbers ringed and recovered 1957, 454, 471-3; foreign-ringed recoveries in Britain, 494.
- Klopfer, P., see MacArthur, R.
- KNOT, status in Tiree and Coll, 54, 114; foreign-ringed recoveries in Britain, 65, 492; numbers ringed and recovered 1957, 456, 468.
- Koffán, K., Photographs of Scops Owl, pl. 25-28.
- Lagopus scoticus*, see Grouse, Red.
- Lanius collurio*, see Shrike, Red-backed.
- , *excubitor*, see Shrike, Great Grey.
- , *minor*, see Shrike, Lesser Grey.
- , *senator*, see Shrike, Woodchat.
- LAPWING, habitat in Coto Doñana, 11, 17-18; status in Tiree and Coll, 52, 114; foreign-ringed recoveries in Britain, 63, 491; information wanted on fledging period, 128; habitat in Camargue, 334, 347; numbers ringed and recovered 1957, 453, 467.
- LARK, CALANDRA, habitat in Coto Doñana, 17; habitat in Camargue, 342.
- , CRESTED, habitat in Camargue, 334, 342, 346.
- , LESSER SHORT-TOED, habitat in Coto Doñana, 17.
- , SHORT-TOED, habitat in Coto Doñana, 11, 17-18, pl. 11; habitat in Camargue, 325-6, 334, 342, 347.
- , THEKLA, habitat in Coto Doñana, 3, 21.
- LARKS, see also Skylark, Woodlark.
- Larus argentatus*, see Gull, Herring.
- , *canus*, see Gull, Common.
- , *fuscus*, see Gull, Lesser Black-backed.
- , *genei*, see Gull, Slender-billed.
- , *glaucoides*, see Gull, Iceland.
- , *hyperboreus*, see Gull, Glaucous.
- , *marinus*, see Gull, Great Black-backed.
- , *minutus*, see Gull, Little.
- , *ridibundus*, see Gull, Black-headed.
- Leach, E. P., British recoveries of birds ringed abroad, 57-72, 487-496.
- Limicola falcinellus*, see Sandpiper, Broad-billed.
- Limosa lapponica*, see Godwit, Bar-tailed.
- , *limosa*, see Godwit, Black-tailed.
- LINNET, foreign-ringed recovery in Britain, 71; status in Tiree and Coll, 110, 117; habitat in Camargue, 335, 342, 347; numbers ringed and recovered 1957, 455, 486.
- Locustella lauceolata*, see Warbler, Lanceolated.
- , *luscinoides*, see Warbler, Savi's.
- , *naevia*, see Warbler, Grasshopper.
- London Natural History Society, centenary, 409-412.
- Loxia curvirostra*, see Crossbill.
- , *pytyopsittacus scotica*, see Crossbill, Scottish.
- Lullula arborea*, see Woodlark.
- Luscinia luscinia*, see Nightingale, Thrush.
- , *megarhynchos*, see Nightingale.
- Luscinola melanopogon*, see Warbler, Moustached.

- Lymnocyptes minimus*, see Snipe, Jack.
- Lyrurus tetrix*, see Grouse, Black.
- MacArthur, R. and Klopfer, P., Note on North American birds staying on board ship during Atlantic crossing, 358.
- McCartan, Leontia, The wreck of Kittiwakes in early 1957, 253-266; mortality of Kittiwakes during the breeding season, 267-8.
- Macfarlane, A. M., Letter on "Science and the bird-watcher", 129.
- McLean, Ivor, and Williamson, Kenneth, Waders at ocean weather ships in 1956, 152-6; note on Merlins at sea, 157-8; migrant land-birds in the Western Approaches, 351-3.
- MAGPIE, habitat in Coto Doñana, 8, 10; burying and recovering food, 275; rapid replacement of dead mate, 309, 401-2; habitat in Camargue, 325, 329, 335, 341, 343, 347; numbers ringed and recovered 1957, 454.
- , AZURE-WINGED, habitat in Coto Doñana, 8, 22, pl. 11.
- Makatsch, Wolfgang, Reports from Britain of Black-headed Gulls ringed at the Oberlausitz, East Germany, 74-77.
- MALLARD, habitat in Coto Doñana, 17, 20; status in Tiree and Coll, 47, 112; foreign-ringed recoveries in Britain, 58, 489; habitat in Camargue, 327, 330-2, 337, 340, 346; numbers ringed and recovered 1957, 453, 462.
- MARTIN, HOUSE, status in Tiree and Coll, 106, 115; apparent coition with Sand Martin, 121; attempted coition with Sand Martin, 308-9; habitat in Camargue, 346; numbers ringed and recovered 1957, 454.
- , SAND, status in Tiree and Coll, 106, 115; apparent coition with House Martin, 121; attempted coition with House Martin, 308-9; spring migration in Western Approaches, 351; numbers ringed and recovered 1957, 454, 476.
- Mather, J. R. and Dickens, R. F., Note on White-rumped Sand-piper in Yorkshire, 80.
- Melanitta nigra*, see Scoter, Common.
- Melanocorypha calandra*, see Lark, Calandra.
- MERGANSEER, RED-BREASTED, status in Tiree and Coll, 48, 113; numbers ringed 1957, 456; foreign-ringed recoveries in Britain, 490.
- Mergus albellus*, see Smew.
- *merganser*, see Goosander.
- *serrator*, see Merganser, Red-breasted.
- MERLIN, status in Tiree and Coll, 51, 113; in N. Atlantic, 157-8; migration, 181-3; body-size in relation to migration, 225-6; numbers ringed and recovered 1957, 453, 466.
- Merops apiaster*, see Bee-eater.
- MIGRATION, Waders in N. Atlantic, 152-6; body-size in relation to, 209-32.
- , Cormorant, 176; Shelduck, 272-4; Buzzard, 86; Marsh Harrier, 89; Hen Harrier, 89-91; Montagu's Harrier, 91-2; Osprey, 92; Sparrowhawk, 86-9; Hobby, 179-80; Peregrine, 180-1; Merlin, 181-3; Kestrel, 183-8; Black-headed Gull, 74-77; Black Tern, 242.
- , see also Leach, E. P.; Ringing report.
- Mills, P. R., and Watson, A. B., Note on Red-breasted Goose in Sussex, 192.
- Milvus migrans*, see Kite, Black.
- *milvus*, see Kite.
- Minton, C. D. T., Note on Magpie's rapid replacement of dead mate, 309.
- MOORHEN, habitat in Coto Doñana, 17, 20; status in Tiree and Coll, 51, 113; foreign-ringed recoveries in Britain, 63, 491; variant leg and bill colour, 158; habitat in Camargue, 339; autumn migration in Western Approaches, 352; numbers ringed and recovered 1957, 453.
- Motacilla alba alba*, see Wagtail, White.
- *yarvelli*, see Wagtail, Pied.
- *cinerea*, see Wagtail, Grey.
- *flava*, see Wagtail, Yellow.
- *flava*, see Wagtail, Blue-headed.
- Mulligan, W. and Venables, L. S. V., Note on Reed Warblers in Anglesey, 124.
- Muscicapa albicollis*, see Flycatcher, Collared.

- VULTURE, EGYPTIAN, in Coto Doñana, pl. 7; habitat in Camargue, 338.
- , GRIFFON, in Coto Doñana, pl. 7.
- WAGTAIL, BLUE-HEADED, at Portland Bill, 29.
- , GREY, status in Tiree and Coll, 109, 117; autumn migration in Western Approaches, 352; numbers ringed and recovered 1957, 455, 484.
- , PIED, status in Tiree and Coll, 109, 117; numbers ringed and recovered 1957, 455, 484.
- , WHITE, foreign-ringed recoveries in Britain, 70, 496; status in Tiree and Coll, 109, 117; body-size in relation to migration, 224; numbers ringed and recovered 1957, 455, 484.
- , YELLOW, habitat in Coto Doñana, 11, 17-18; status in Tiree and Coll, 109, 117; habitat in Camargue, 326-7, 334, 347; autumn migration in Western Approaches, 352; numbers ringed and recovered 1957, 455, 484.
- Wallace, D. I. M., Note on Ruffs displaying in a wintering area, 81-2.
- WARBLER, AQUATIC, at Portland Bill, 28.
- , BARRED, at Portland Bill, 28; in Tiree, 1913, 108; numbers ringed 1957, 455.
- , BLACK-THROATED GREEN, staying on board ship crossing Atlantic, 358.
- , CETTI'S, habitat in Coto Doñana, 23; habitat in Camargue, 335, 343.
- , DARTFORD, habitat in Coto Doñana, 8, 10; numbers ringed 1957, 456.
- , FAN-TAILED, habitat in Coto Doñana, 11, pl. 2; habitat in Camargue, 335.
- , GARDEN, status in Tiree and Coll, 108, 116; numbers ringed 1957, 455.
- , GRASSHOPPER, in Tiree and Coll, 108; numbers ringed 1957, 455.
- , GREAT REED, habitat in Coto Doñana, 17; habitat in Camargue 339, pl. 56.
- WARBLER, GREENISH, in Kent, 125; numbers ringed 1957, 456.
- , ICTERINE, numbers ringed 1957, 456.
- , LANCEOLATED, at Fair Isle, 243-4; ringed 1957, 456.
- , MARSH, at Portland Bill, 28; numbers ringed 1957, 456.
- , MELODIOUS, habitat in Coto Doñana, 10-11; habitat in Camargue, 335, 343, 347; numbers ringed 1957, 456.
- , MOUSTACHED, habitat in Camargue, 339.
- , OLIVACEOUS, at Portland Bill, 28.
- , ORPHEAN, habitat in Coto Doñana, 8; habitat in Camargue, 341, 346.
- , PALLAS'S, in Norfolk, 197, pl. 36; ringed 1957, 456.
- , PINE, staying on board ship crossing Atlantic, 358.
- , REED, in Co. Down, 124; in Anglesey, 124; habitat in Camargue, 339; numbers ringed and recovered 1957, 455, 481.
- , SARDINIAN, habitat in Coto Doñana, 8, 10; habitat in Camargue, 325, 329, 335, 341.
- , SAVI'S, habitat in Coto Doñana, 11; habitat in Camargue, 339.
- , SEDGE, status in Tiree and Coll, 108, 116; numbers ringed and recovered 1957, 455, 481.
- , SPECTACLED, habitat in Coto Doñana, 10; habitat in Camargue, 327, 334, 347, pl. 56.
- , SUBALPINE, habitat in Camargue, 341.
- , TENNESSEE, staying on board ship crossing Atlantic, 358.
- , WILLOW, unusual song and display-flight, 83; status in Tiree and Coll, 108, 116; numbers ringed and recovered 1957, 455, 483.
- , WOOD, status in Tiree and Coll, 108, 116; habitat in Camargue, 325; numbers ringed and recovered 1957, 455.
- , YELLOW-BROWED, in Tiree and Coll, 1906, 108; numbers ringed 1957, 456.
- WARBLERS, see also Blackcap, Chiffchaff, Whitethroat.
- Warham, John, Photographic studies of some less familiar birds: XC, Frigate Petrel, 269-72, pl. 41-44; XCI, Bridled Tern, 303-8, pl.

- 45-48; XCII, Little Shearwater, 393-7, pl. 64-67; letter on the distribution of the Frigate Petrel, 448.
- Watson, A. B., see Mills, P. R.
- Wayre, Philip and Jolly, G. F., Notes on the breeding of the Iceland Gyr Falcon, 285-90.
- WAXWING, numbers ringed and recovered 1957, 456.
- West, D. G. H. and Haywood, P. B., Note on White-winged Black Tern in Lincolnshire, 159.
- WHEATEAR, foreign-ringed recoveries in Britain, 70, 496; in N. Atlantic, 98; status in Tiree and Coll, 107, 116; body-size in relation to migration, 211-20; numbers ringed and recovered 1957, 455, 480; spring migration in Western Approaches, 351.
- , BLACK-EARED, habitat in Camargue, 342, pl. 60.
- , DESERT, in Essex, 275-6.
- WHIMBREL, status in Tiree and Coll, 53; body-size in relation to migration, 227-8; numbers ringed 1957, 456.
- WHINCHAT, status in Tiree and Coll, 107, 116; numbers ringed and recovered 1957, 455.
- WHITETHROAT, status in Tiree and Coll, 108, 116; taking insects from water, 309; habitat in Camargue, 335; numbers ringed and recovered, 455, 482.
- , LESSER, numbers ringed and recovered 1957, 455, 482.
- WIGEON, status in Tiree and Coll, 47, 112; foreign-ringed recoveries in Britain, 60, 489; habitat in Camargue, 327, 341; numbers ringed and recovered 1957, 453, 464.
- Williamson, Kenneth, Bergmann's rule and obligatory overseas migration, 209-32; population and breeding environment of the St. Kilda and Fair Isle Wrens, 369-93, pl. 61-63.
- , —, see McLean, Ivor.
- Williamson, Kenneth, Recent reports and news, see Reports and news.
- Wilson, D. R., Note on Leach's Petrel in Shetland, 77-8.
- WOODCOCK, status in Tiree and Coll, 53, 114; foreign-ringed recoveries in Britain, 65, 492; numbers ringed and recovered 1957, 453.
- WOODLARK, habitat in Coto Doñana, 8; habitat in Camargue, 341, 346; numbers ringed 1957, 454.
- WOODPECKER, GREAT SPOTTED, habitat in Camargue, 343; numbers ringed and recovered 1957, 454, 476.
- , GREEN, habitat in Coto Doñana, 8, 10; habitat in Camargue, 335, 343; numbers ringed and recovered, 454, 476.
- , LESSER SPOTTED, habitat in Camargue, 343; numbers ringed 1957, 456.
- WOODPIGEON, habitat in Coto Doñana, 8, 10, 21; status in Tiree and Coll, 105, 115; song-period in Flintshire, 160-1; habitat in Camargue, 346; numbers ringed and recovered 1957, 454, 475.
- WREN, breeding behaviour in the Aran Islands, Ireland, 29-35; status in Tiree and Coll, 106, 116; numbers ringed and recovered 1957, 455, 478.
- , FAIR ISLE, population and habitat, 385-7, 387-93.
- , ST. KILDA, population and habitat, 369-85, 387-93, pl. 61-63.
- WRYNECK, numbers ringed and recovered 1957, 454, 476.
- Xema sabini*, see Gull, Sabine's.
- YELLOWHAMMER, status in Tiree and Coll, 110, 117; late season song, 290-303; numbers ringed and recovered 1957, 455; sub-song, 513.
- Zonotrichia albicollis*, see Sparrow, White-throated.



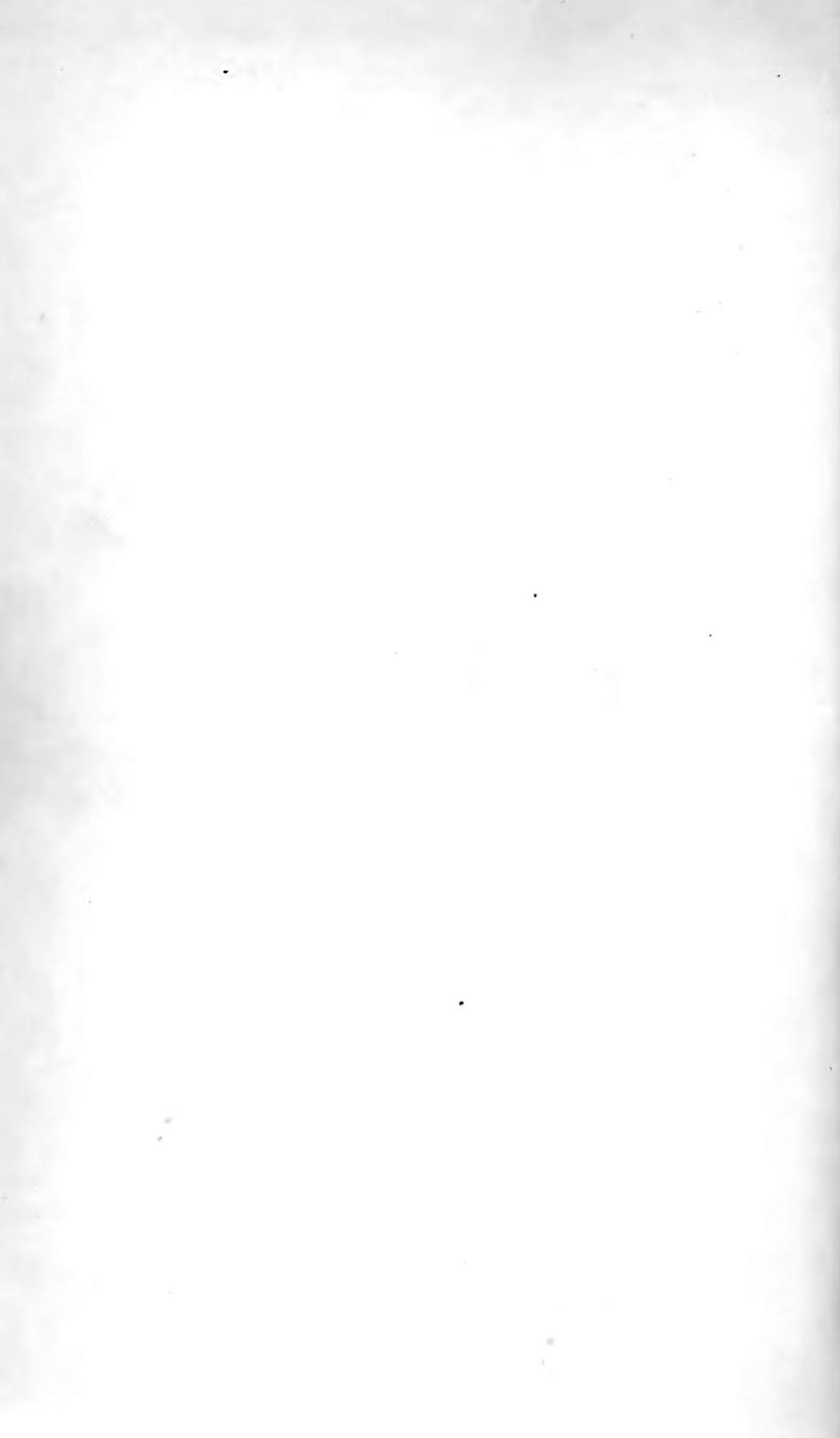

3  
129 HC/-

